

Globalization, Energy, and Growth:

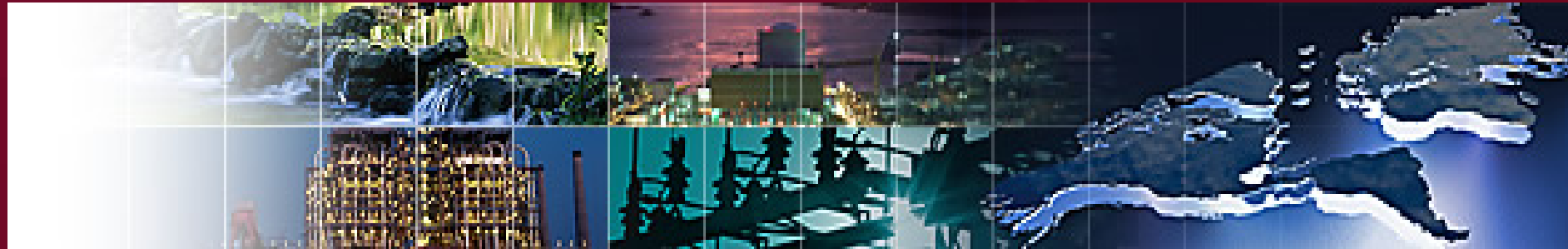
Exploring and understanding implications of “The World is Flat” for science- and technology-intensive organizations and what that means for individuals, organizations, innovation, R&D, and opportunities for growth

S. Massoud Amin, D.Sc.

Director and Honeywell/H.W. Sweatt Chair in Technological Leadership

Professor of Electrical & Computer Engineering

University Distinguished Teaching Professor



Rochester Signature Series Summit
Tuesday, 8:30-4:30, October 27, 2009

**TECHNOLOGICAL
LEADERSHIP INSTITUTE**

UNIVERSITY OF MINNESOTA

Driven to DiscoverSM

Copyright © 2009 No part of this presentation may be reproduced in any form without prior authorization.

Agenda for today's workshop:

- Internationalization of high technology enterprises, R&D, and technology commercialization trends in the global context
- Regional, Government and institutional factors affecting technological and business development
- Intellectual property policy, law, management and strategy
- Technological products and services
- Case studies: Information Technology, Energy, biosciences/pharma, IP and other selected areas focused on India and China
- Marketing analyses-- How do the market factors look?
- Infrastructure for power/energy and transportation
- Work force retention and escalating salaries
- Cost factors vs. emphasis on expertise
- Lessons learned, time lines, surprises, threats and opportunities
- Blockers, Accelerators, and the Next Steps: Possible innovations in global technology environment



Effects of Tech Globalization: Please consider the following questions & map out your thoughts

- Context for technology development and management in global environments.
- How has it evolved over time and where are the likely destinations in the next 2-5 and 5-20 years?
- What are the key processes, models and the whole "system" for this shift: Inputs, outputs, stimuli, dynamics, players and actors, processes, incentives, and control mechanisms (blockers and accelerators)?
- How does it affect you individually, your organizations, and technology/market sectors?
- Who is the target audience?
 - Basically “what does all this mean to you and to our organizations in Minnesota?”
- What is your leadership role?
 - Find, highlight and analyze part(s) of the above opportunities that you or your organizations/companies in Minnesota can potentially lead as new business development or forming alliances.

Effects of Tech Globalization

- **By the end of 2008, China and India account for 31% of global R&D staff, up from 19% in 2004.**
- **77% of new R&D sites planned for next 3 years will be built in China or India.**
- **The US ranks 17th among developed nations in the proportion of college students majoring in science and engineering.**

Global Technology Diffusion

Guangdong
Science Center --
China
Opened 2008



June 2006

Trends

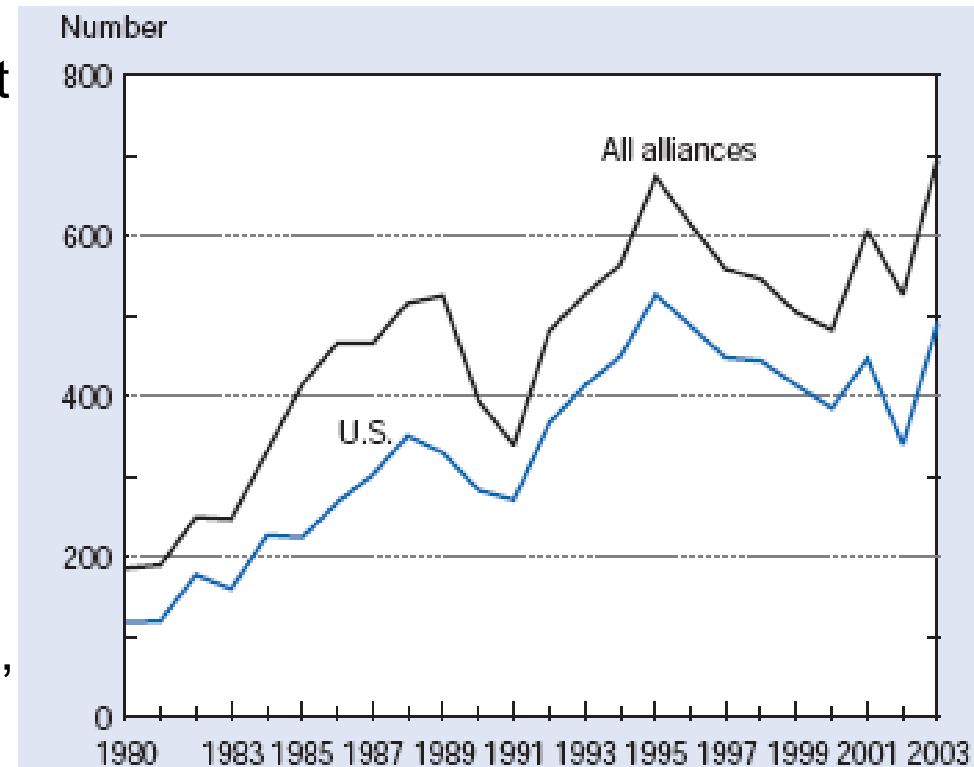
- Internet users grew 183% from 2000. 1 billion users last year. 2 billion by 2011.
- 2 billion cell phones this year. 3 billion by 2009.
- Wireless “hotspots” grew 87% in one year. Now 100,000. 200,000 by 2010.



Change

Worldwide industrial technology alliances and those with at least one U.S.-owned company: 1980–2003

1. The Cooperative Agreements and Technology Indicators database-Maastricht Economic Research Institute on Innovation and Technology (CATI-MERIT, funded in part by NSF), includes domestic and international technology agreements
2. In 2003 (latest data available) there were 695 new industrial technology alliances Worldwide.
3. These alliances involve mostly companies from the United States, Europe, and Japan, focusing to a large extent on **biotechnology and information technology products**, services, or techniques.
4. Other technology areas include advanced materials, aerospace and defense, automotive, and (non-biotechnology) chemicals.



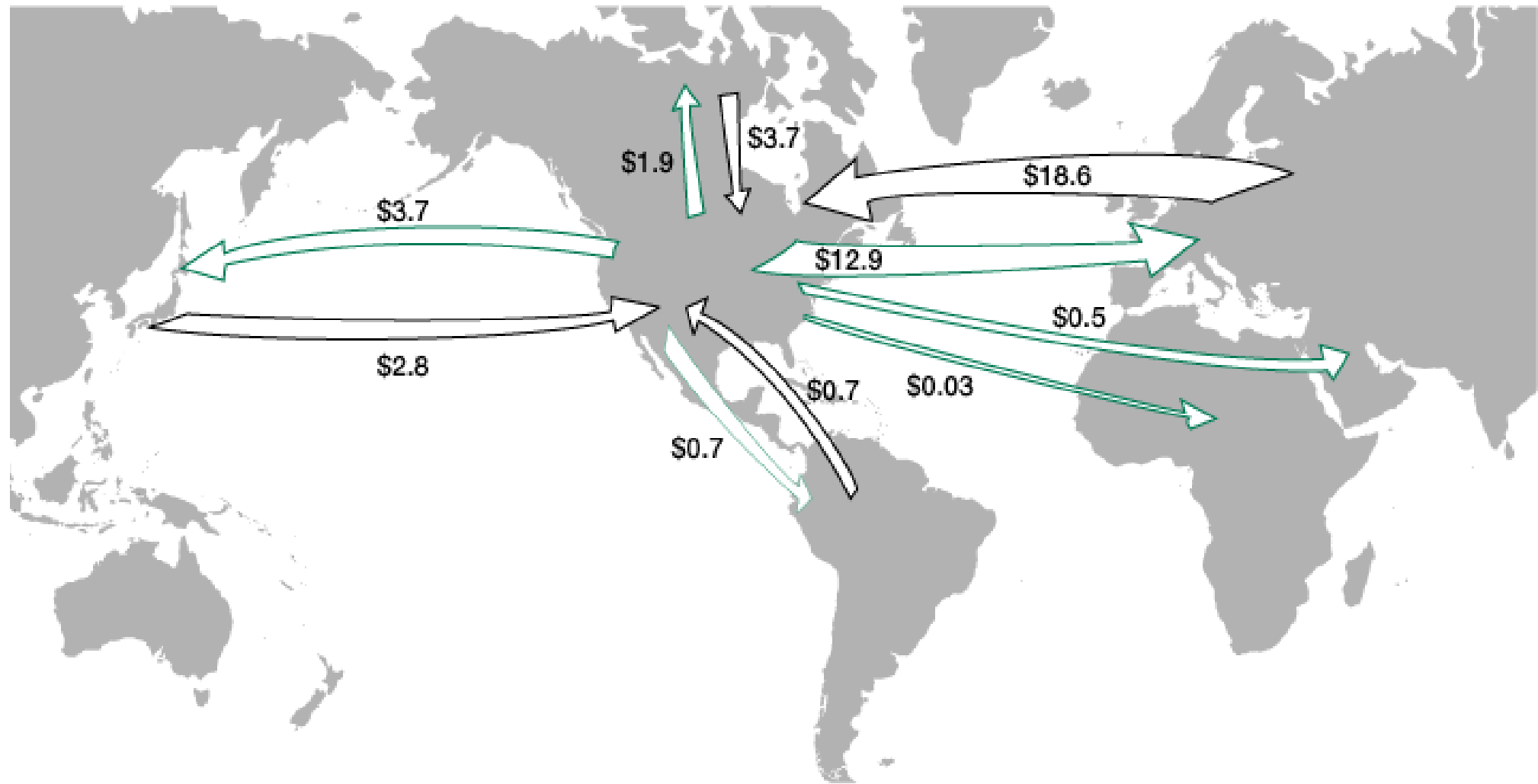
NOTE: Annual counts of new alliances.

SOURCE: Maastricht Economic Research Institute on Innovation and Technology, Cooperative Agreements and Technology Indicators (CATI-MERIT) database, special tabulations.

SOURCE: National Science Board, *Science and Engineering Indicators-2008*

Foreign-owned R&D in United States and U.S.-owned R&D overseas, by investing/host region

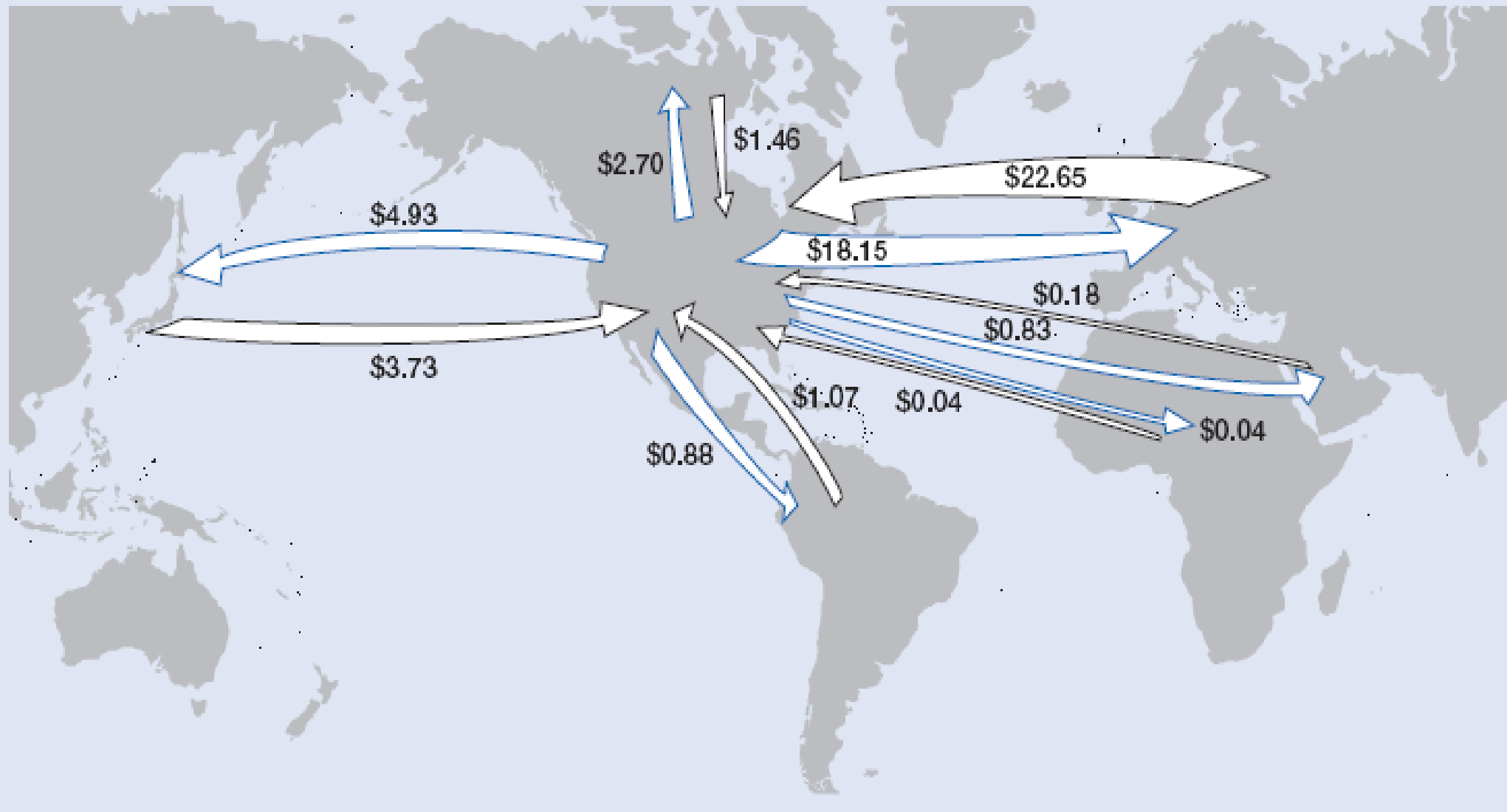
(Billions of current U.S. dollars)



SOURCE: National Science Board, *Science and Engineering Indicators-2000*

Foreign-owned R&D in United States and U.S.-owned R&D overseas, by investing/host region: 2004 or later

Current U.S. dollars (billions)



SOURCE: National Science Board, *Science and Engineering Indicators-2008*

Macroeconomic Rationale

1. Endogenous growth models - theoretical support for domestic technology creation
2. $Y = f(R, K, H)$, where:
 - $Y = \text{GDP}$
 - $R = \text{R\&D}$
 - $K = \text{physical capital}$
 - $H = \text{human capital}$
3. GDP growth: a) Velocity and proportion of R, K, H, and
b) available and affordable energy: determinants of success

GDP Density



Satellite picture of the earth at night



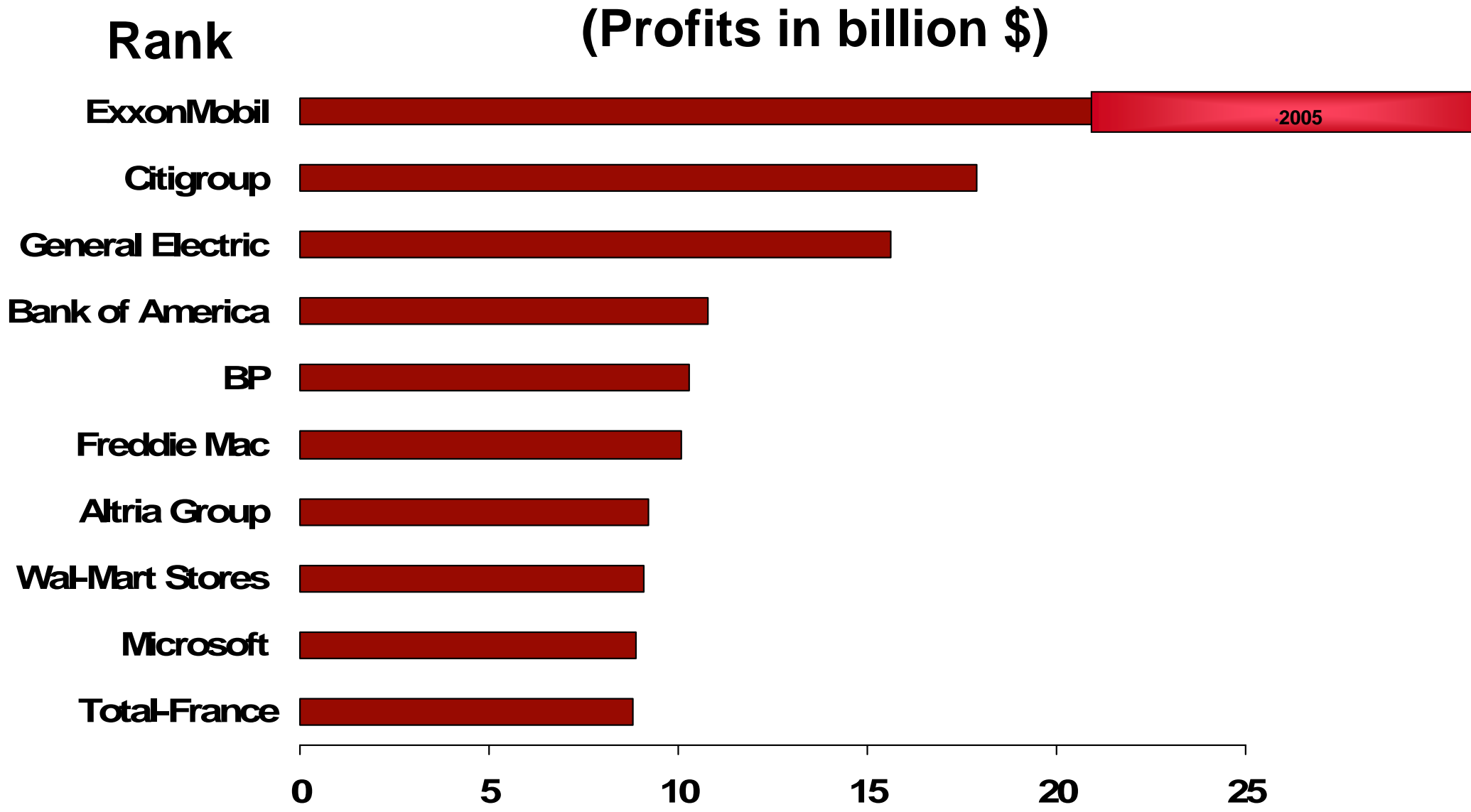
HOW DO WALMART'S SALES COMPARE?

Sweden	GDP	\$301.6b
Wal-Mart Stores <i>(year ending 1/31/05)</i>	Total Revenue	\$287.8b
Austria	GDP	\$253.1b
Turkey	GDP	\$240.3b
Norway	GDP	\$220.8b
Ireland	GDP	\$153.7b
Israel	GDP	\$110.2b
New Zealand	GDP	\$79.5b
Chile	GDP	\$72.4b

GDP Source: WDI, World Bank



World's 10 most profitable companies



Source: Forbes Feb, 2004

World's 10 Most Profitable Companies

Rank (Country)	Profits in billion \$
1. ExxonMobil (United States)	\$ 40.61
2. Royal Dutch Shell (Netherlands)	\$ 31.33
3. Gazprom (Russia)	\$ 23.304
4. General Electric (United States)	\$ 22.22
5. BP (United Kingdom)	\$ 20.61
6. Total (France)	\$ 19.247
7. HSBC Holdings (United Kingdom)	\$ 19.14
8. Chevron (United States)	\$ 18.70
9. PetroChina (China)	\$ 18.21
10. Microsoft (United States)	\$ 16.96

Source: Forbes, July 2008



2009 FORTUNE 500 ranking of America's largest corporations

Rank/ <u>Company</u>	Revenues (\$ millions)	Profits (\$ millions)
1. <u>Exxon Mobil</u>	442,851.0	45,220.0
2. <u>Wal-Mart</u>	405,607.0	13,400.0
3. <u>Chevron</u>	263,159.0	23,931.0
4. <u>ConocoPhillips</u>	230,764.0	-16,998.0
5. <u>General Electric</u>	183,207.0	17,410.0
6. <u>General Motors</u>	148,979.0	-30,860.0
7. <u>Ford Motor</u>	146,277.0	-14,672.0
8. <u>AT&T</u>	124,028.0	12,867.0
9. <u>Hewlett-Packard</u>	118,364.0	8,329.0
10. <u>Valero Energy</u>	118,298.0	-1,131.0

Source: Forbes, May 2009



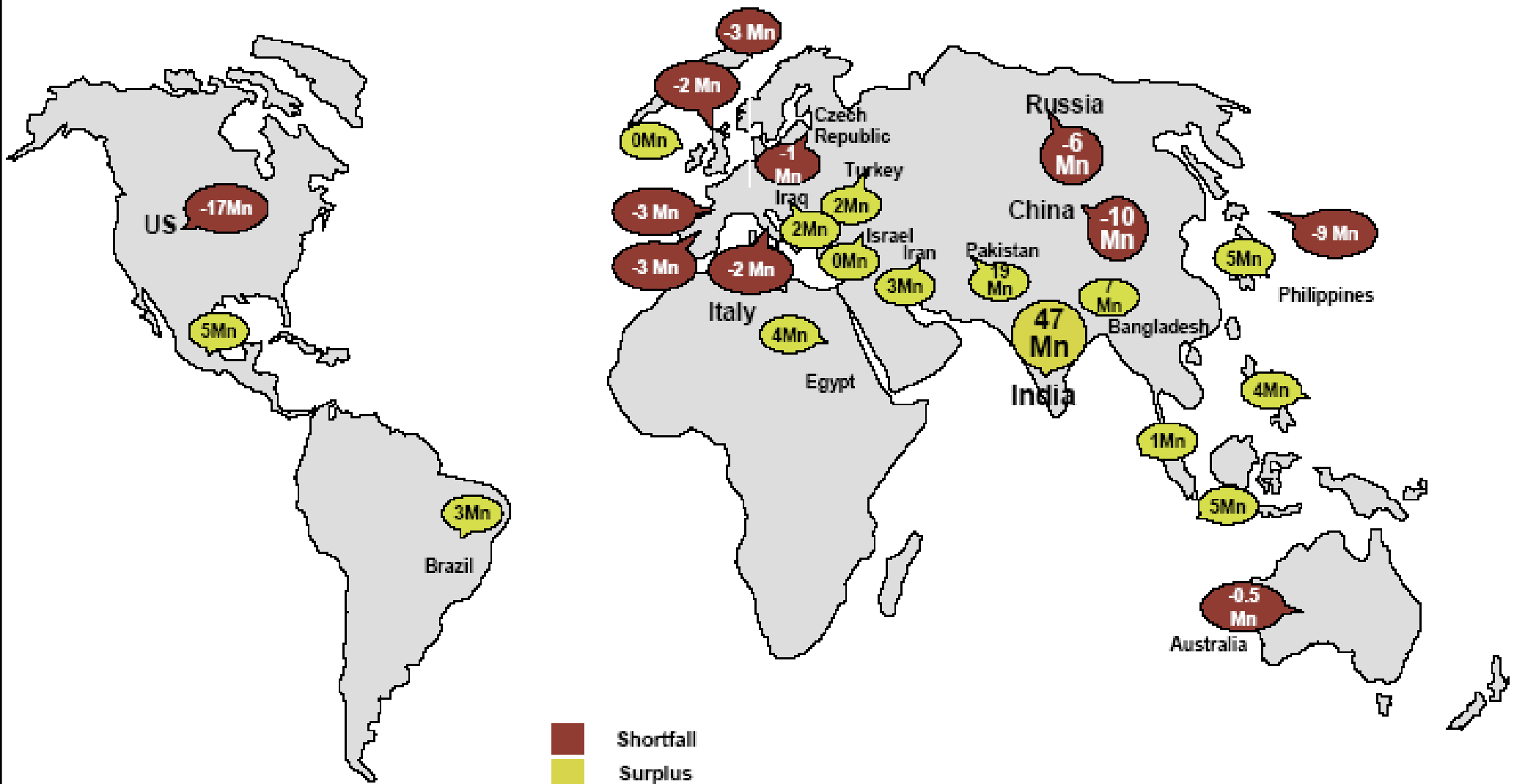
Most profitable Global 500 Companies

Rank / <u>Company</u>	Global 500 Rank	2008 Profits (\$ millions)	Profits % change from 2007
<u>Exxon Mobil</u>	2	45,220.0	11.4
<u>Gazprom</u>	22	29,864.1	16.1
<u>Royal Dutch Shell</u>	1	26,277.0	-16.1
<u>Chevron</u>	5	23,931.0	28.1
<u>BP</u>	4	21,157.0	1.5
<u>Petrobras</u>	34	18,879.0	43.7
<u>Microsoft</u>	117	17,681.0	25.78
<u>General Electric</u>	12	17,410.0	-21.6
<u>Nestlé</u>	48	16,669.6	87.8
<u>Industrial & Commercial</u>			
<u>Bank of China</u>	92	15,948.5	48.8
<u>Total</u>	6	15,500.4	-14.1
<u>BHP Billiton</u>	120	15,390.0	14.7
<u>Petronas</u>	80	15,308.9	-15.5
<u>Wal-Mart Stores</u>	3	13,400.0	5.3
<u>China Construction Bank</u>	125	13,323.7	46.8

Talent Availability Forecast

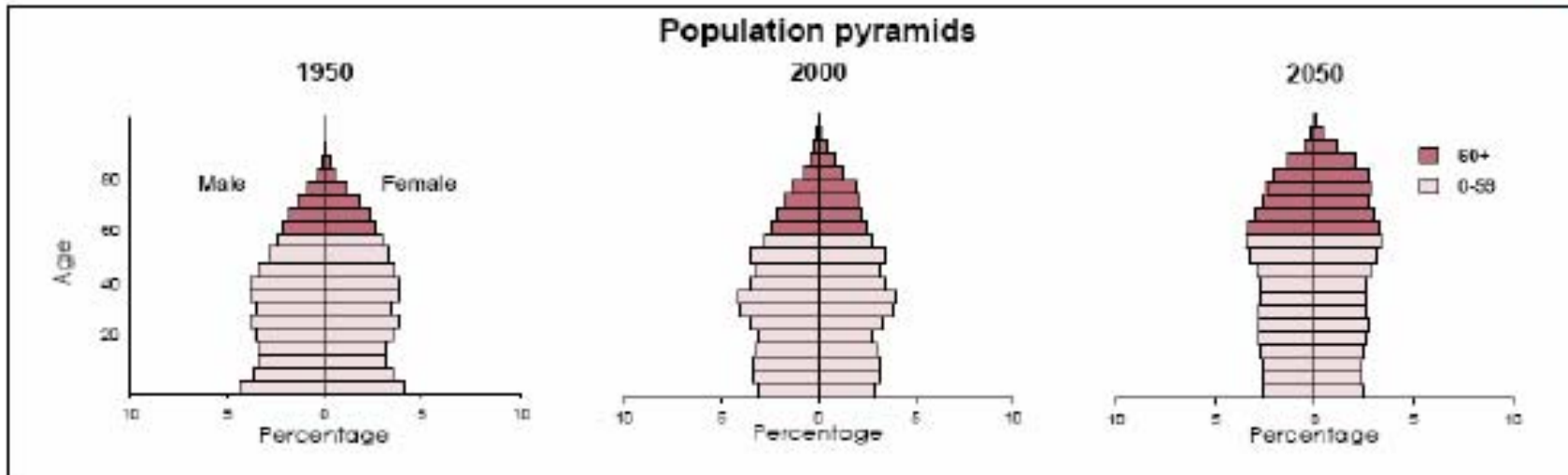


Potential surplus population in working age group (2020)

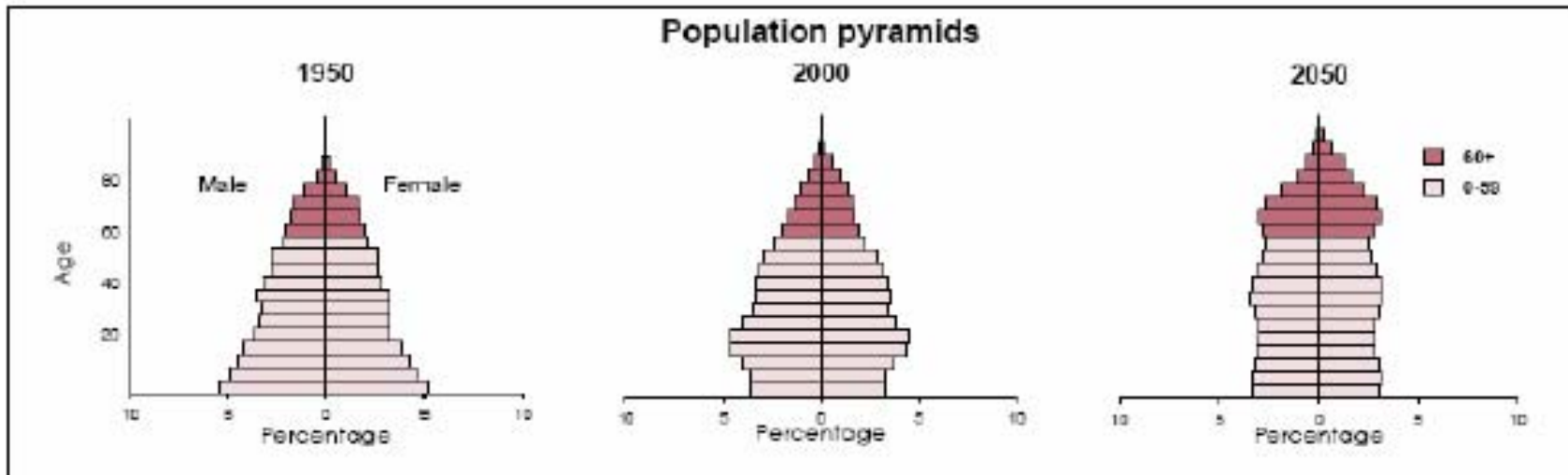


Sources: US Census, Press search, Industry associations

Population Pyramid – UK and Ireland



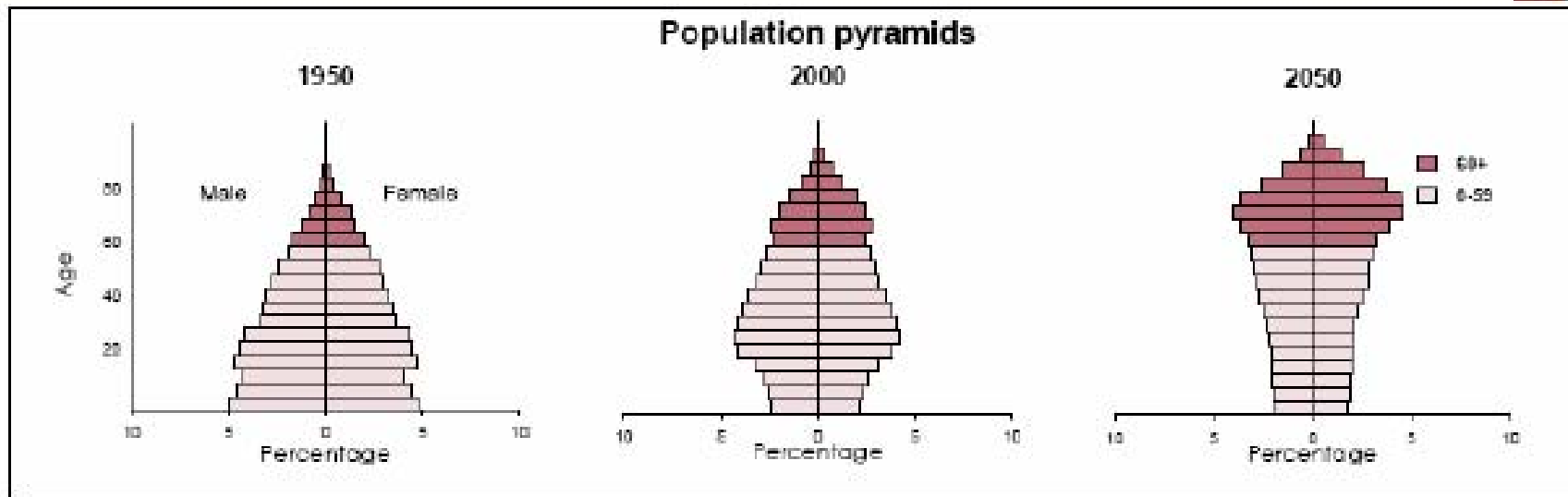
UK



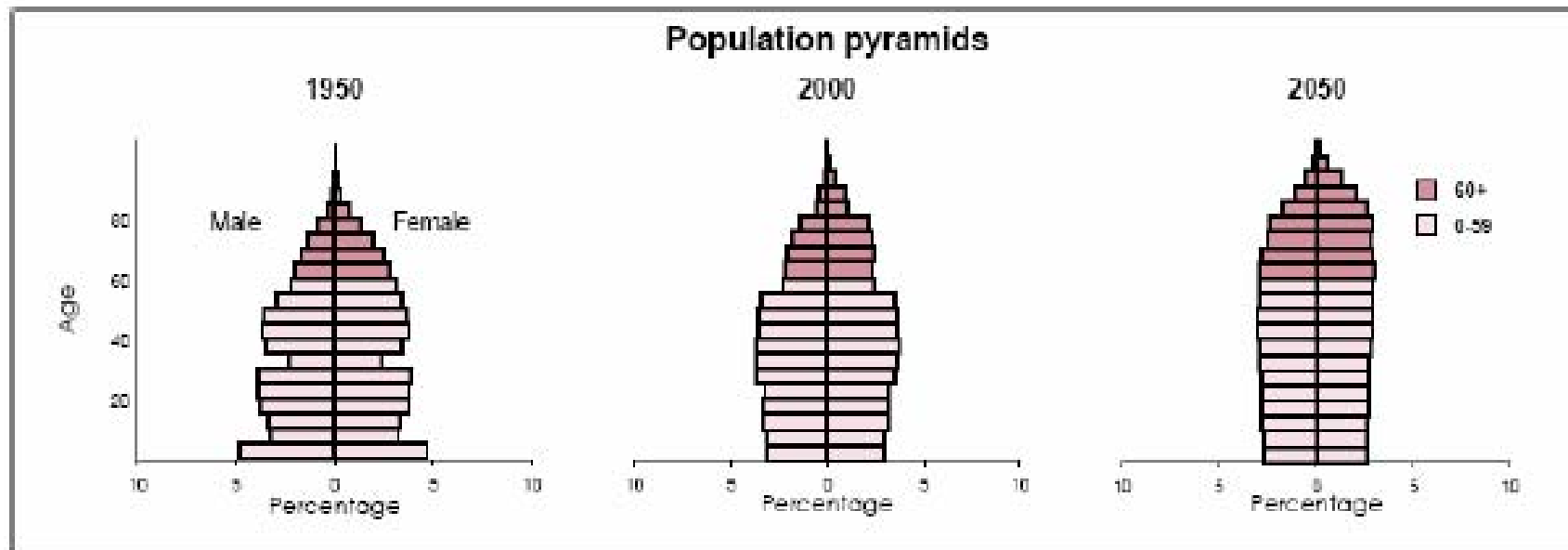
Ireland

Source: Population Division, DESA, United Nations: *World Population Ageing 1950-2050*

Population Pyramid – Spain & France

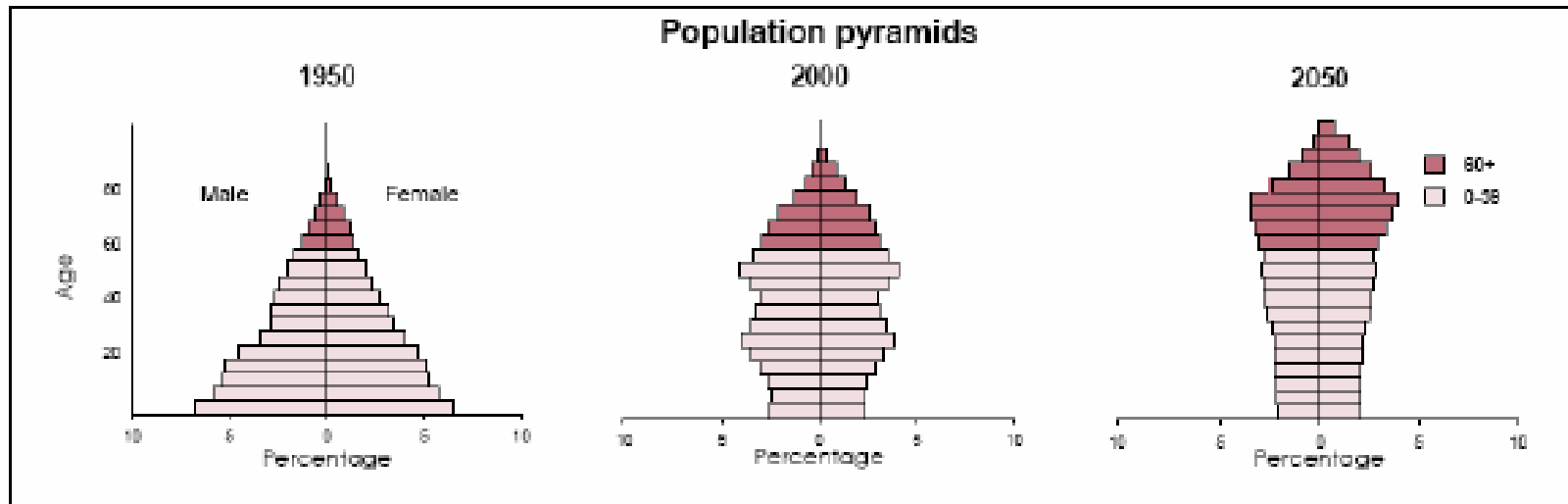


Spain

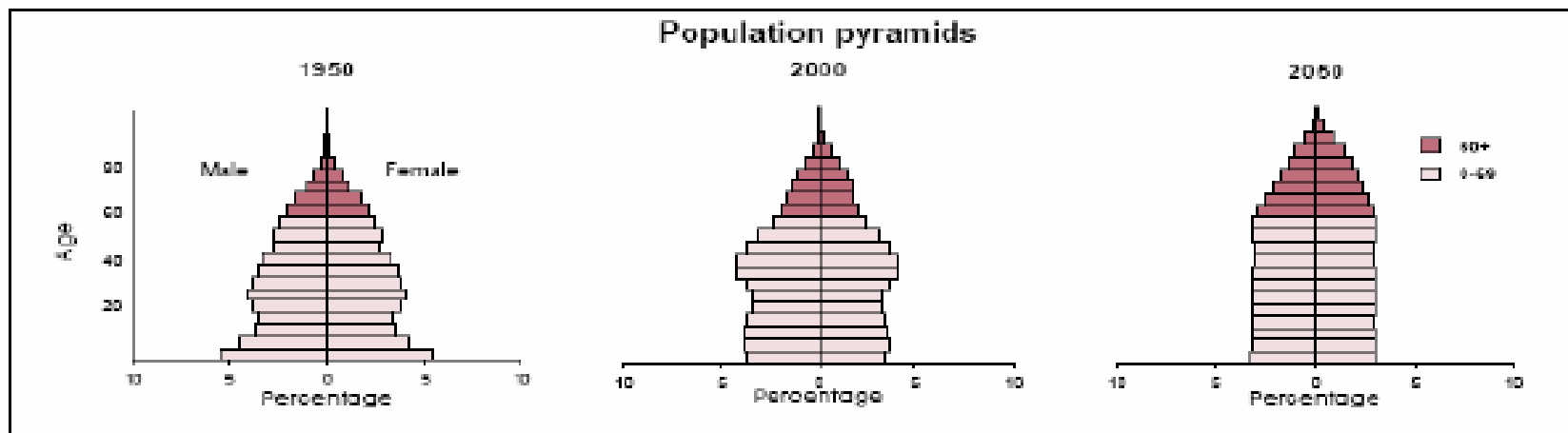


France

Population Pyramids – Japan & US

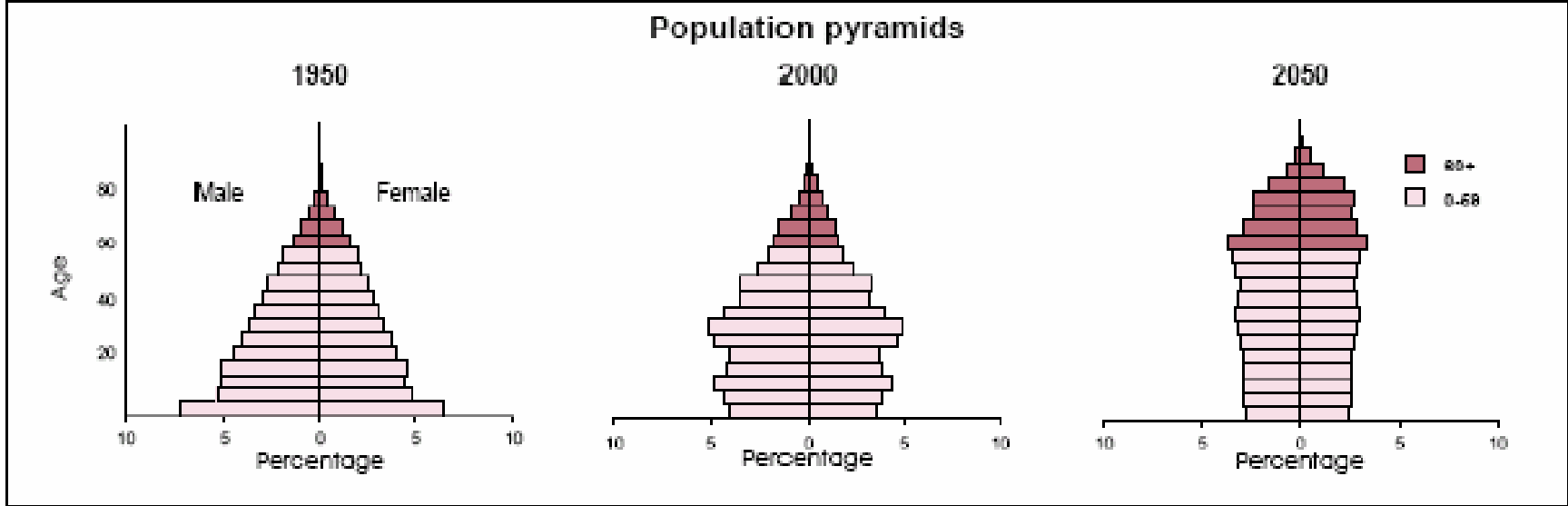


Japan

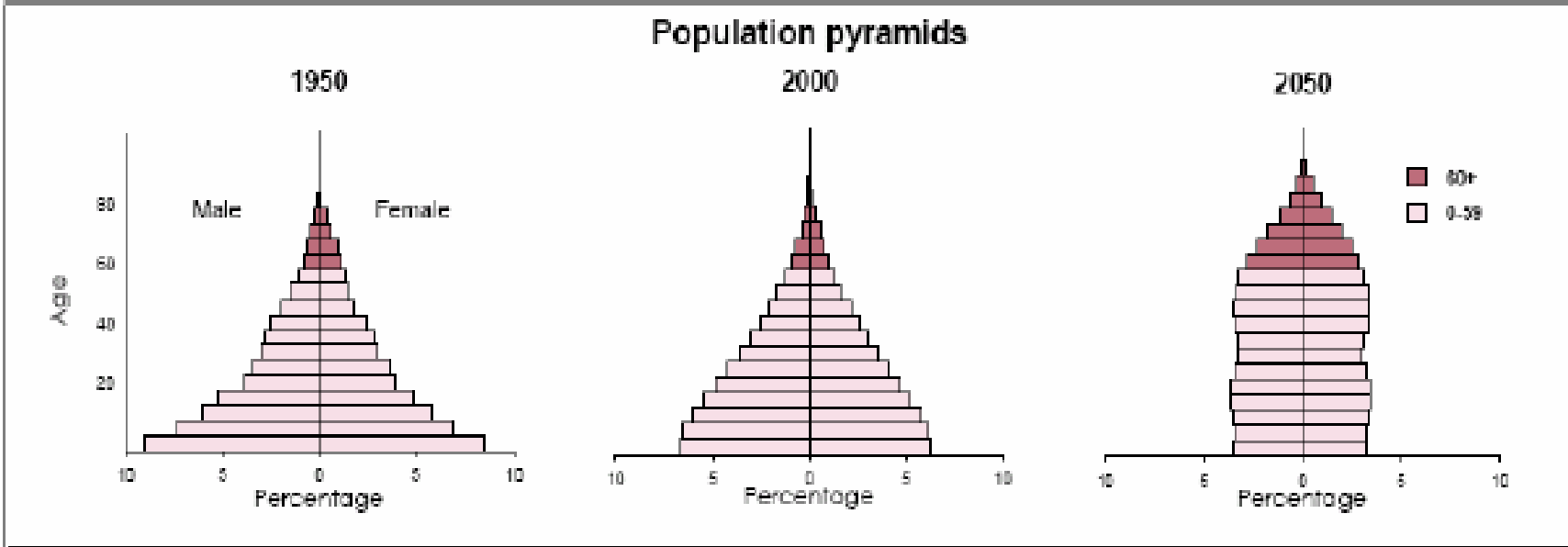


US

Population Pyramids –China & Philippines

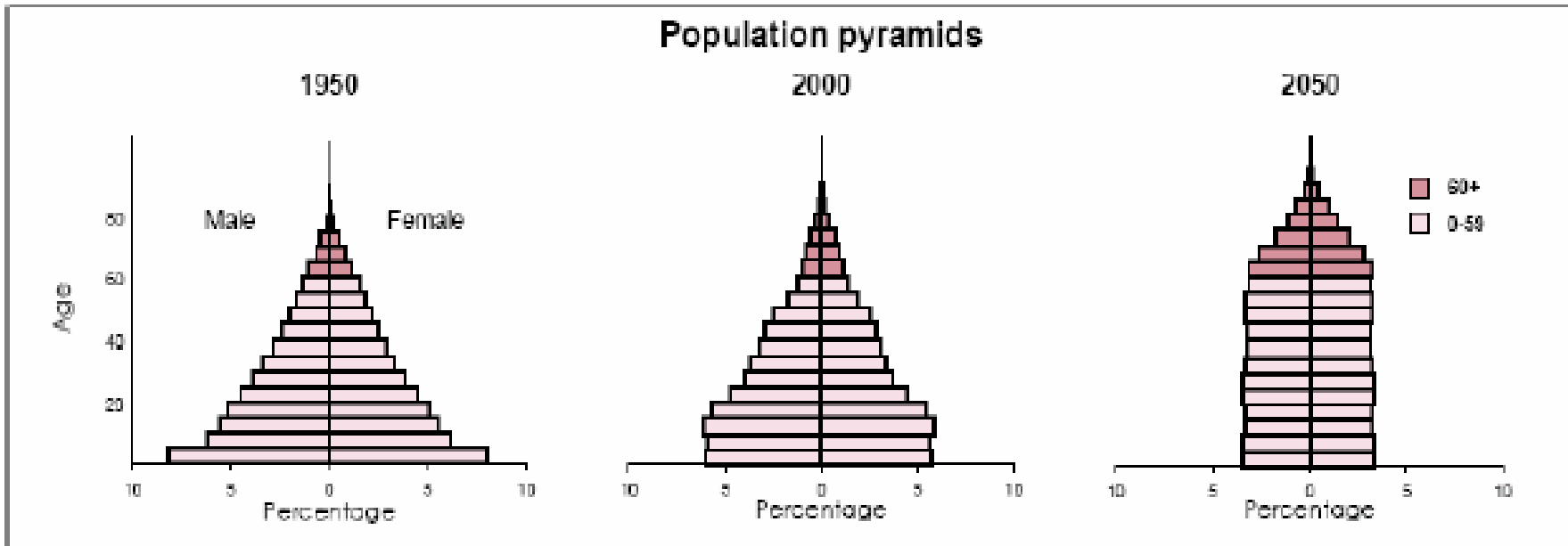
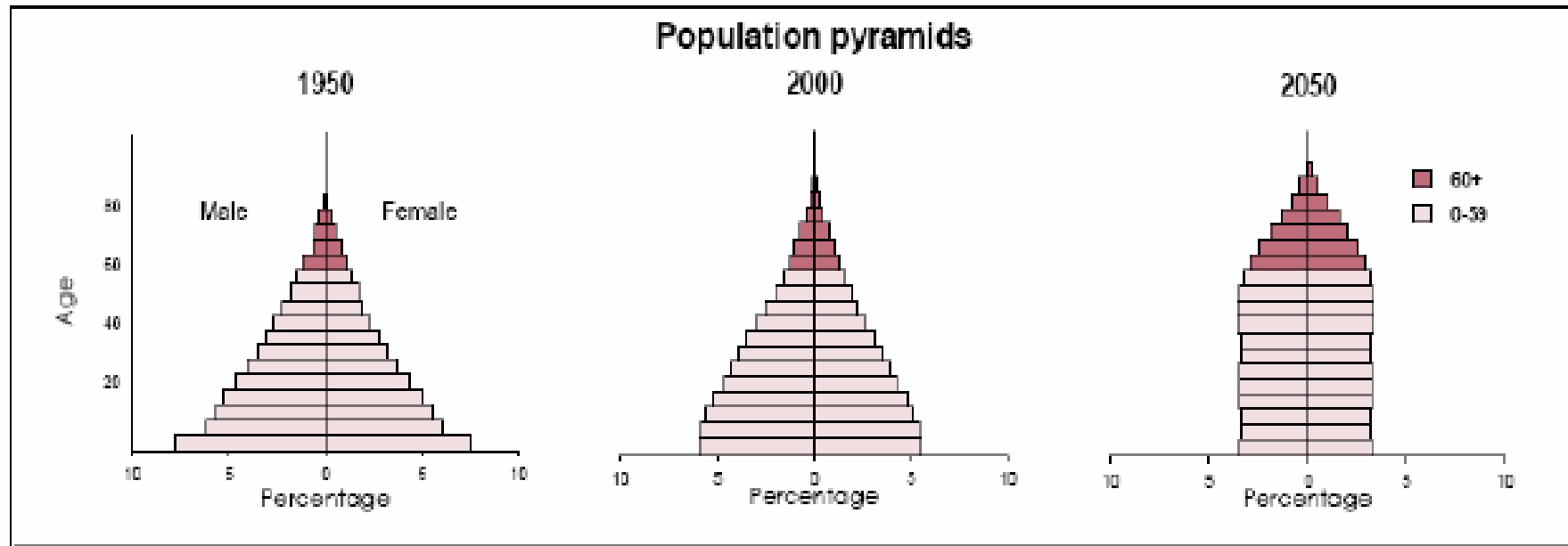


China



Philippines

Population Pyramid – India & Egypt

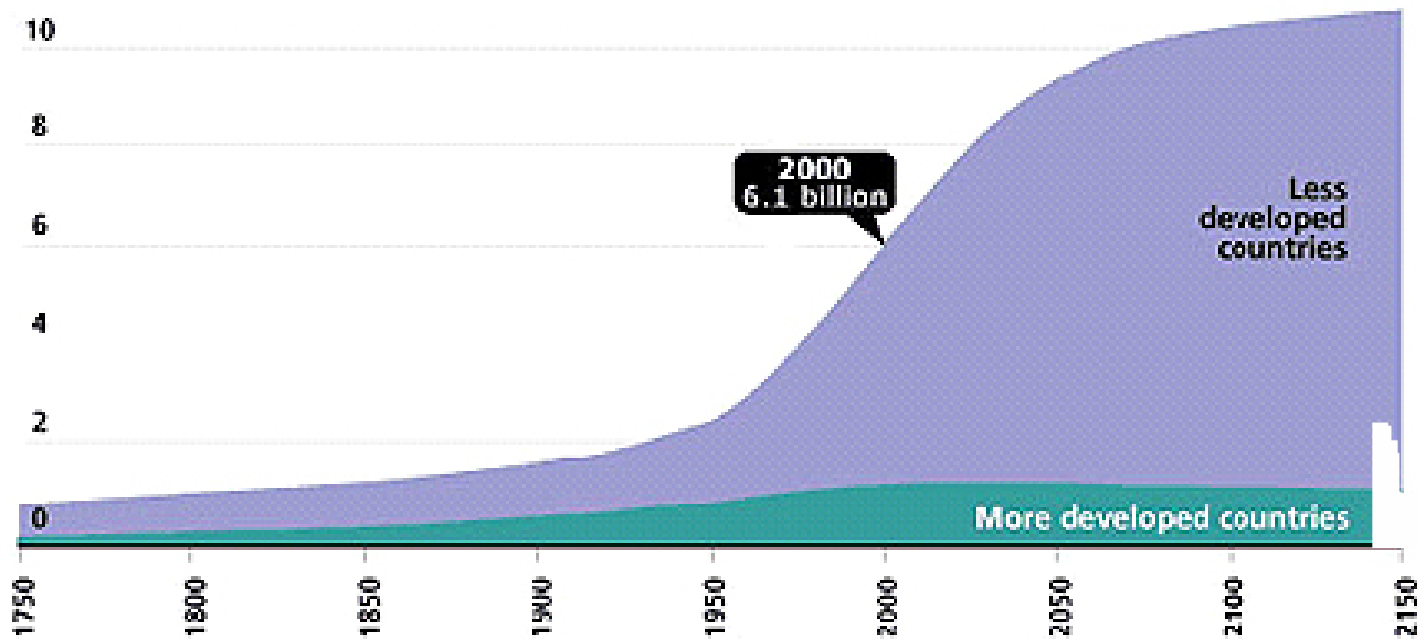


... Population Growth

Today ...

World Population Growth, 1750-2150

Population (in billions)

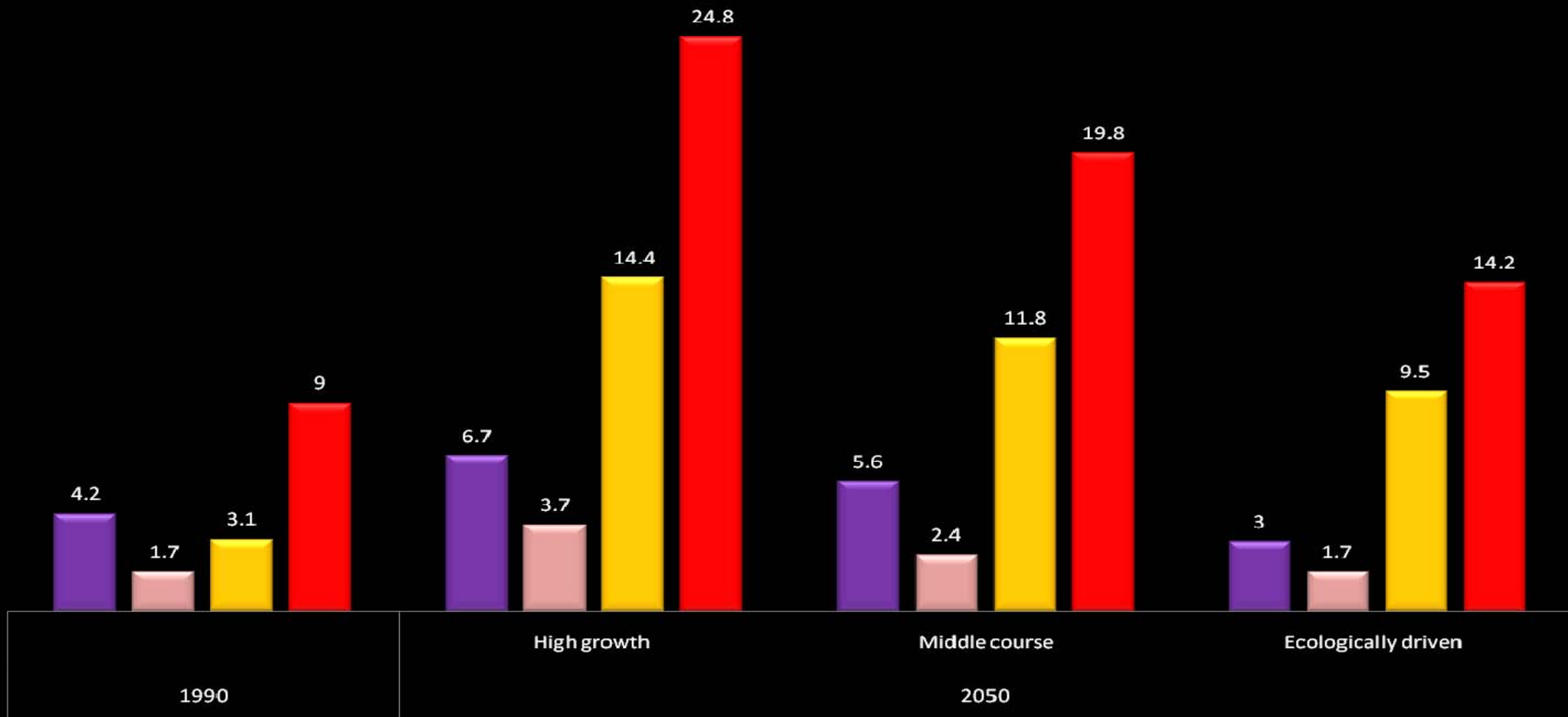


Source: United Nations, *World Population Prospects, The 1998 Revision*; and estimates by the Population Reference Bureau.

Opportunity ... Demand is High

Projections of global primary energy demand to 2050 (Gigatonnes of oil equivalent)

■ OECD ■ Economies in Transition ■ Developing Countries ■ World Total



Change











India

Parts of this presentation were developed for a graduate course at CDTL's Management of Technology (MOT) program for the International Management of Technology (MOT 8950). Considerable input and support from the students in the MOT classes of 2007 and 2007, as well as input from senior colleagues at Honeywell, Cummins Power, 3M, and organizations indicated in India is gratefully acknowledged.

International MOT Projects 2007 and 2008

Goals:

- Contrast between emerging & established (companies, countries, technology, foreign-owned vs. local, govt. vs. private sector, etc.);
- Management of Technology content;
- A “non-U.S. International” academic perspective on MOT;
- Ability to develop a coherent intellectual structure within this region/country (content, sequence, flow)
- Held in [Delhi](#) and [Bangalore](#)



Overview

- Indian economy – The 4th largest & 2nd fastest growing economy in the world
- India GDP for FY 2006 was approx USD 570 bn at constant prices
- A middle class customer base of over 300 million people
- More than 7% GDP growth for four consecutive years
- Targeted growth Rate: 8-9 %
- **Infrastructure a key bottleneck** - a cause for concern?
- Expected investment in infrastructure : USD 320 billion

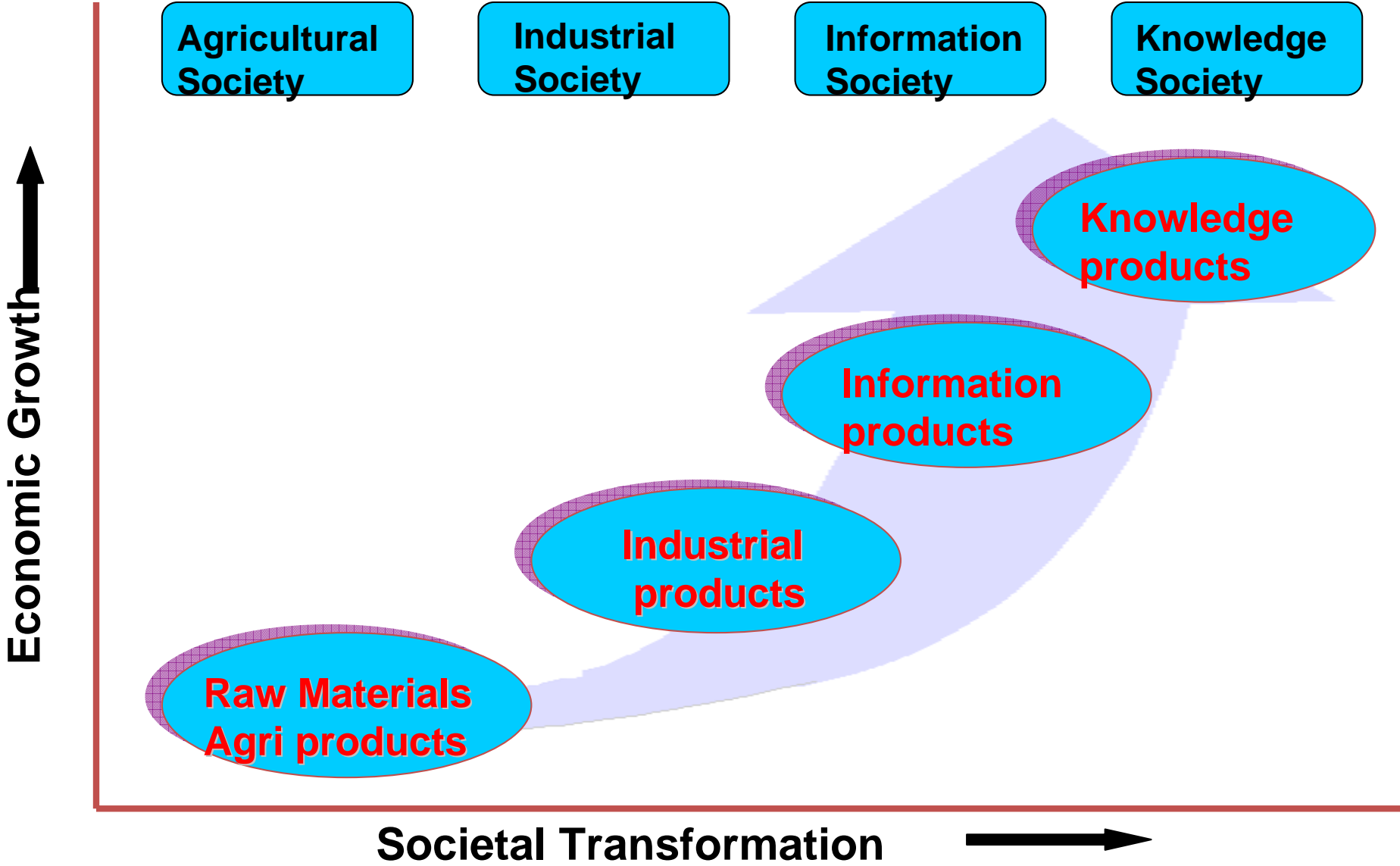
EIU Infrastructure Development Ratings

	Brazil	India	China
2001-05 Rating (out of 10)	5.4	3.1	4.5
2001-05 Ranking	47	75	55
2006-10 Rating (out of 10)	5.9	4.1	5.4
2006-10 Ranking	49	75	54

Source: Economist Intelligence Unit, Country Monitor

Source: Prof. K.C. Iyer, IIT-Delhi

Transformation



Source: Prof. D.K.Banwet, IIT-Delhi





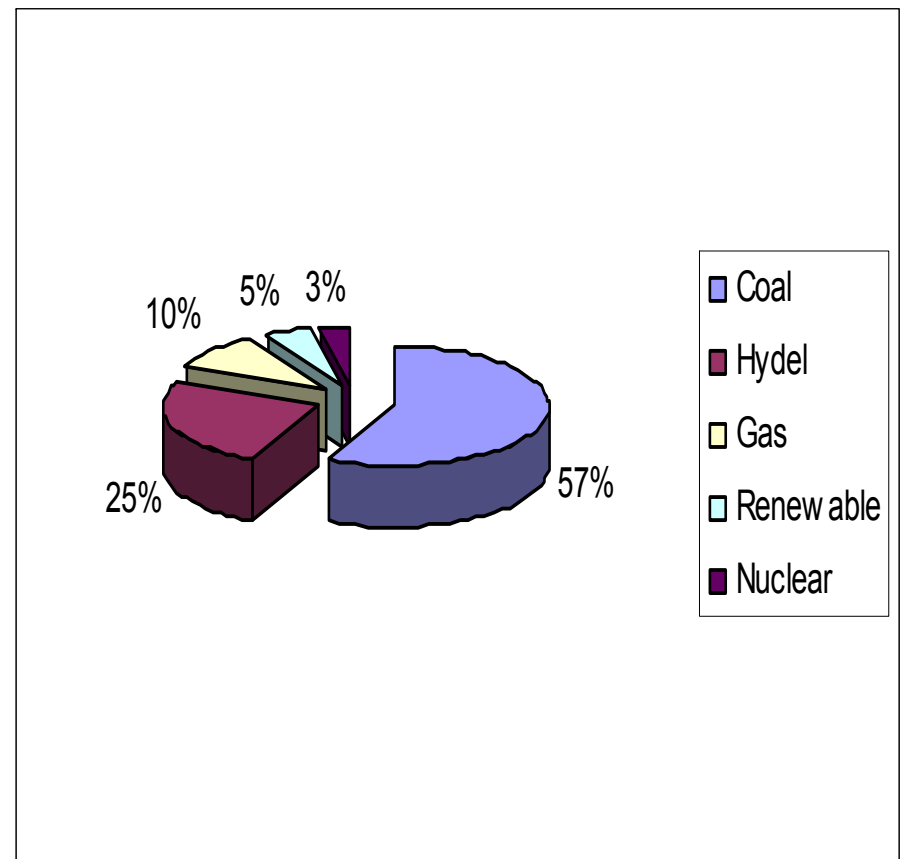
India



survival

Energy: Size

- Generation capacity - 122 GW; 590 billion units produced (1 unit = 1kWh)
- CAGR of 4.6% in period 2002-2006
- India-5th largest electricity generation capacity in world
- Low per capita consumption at 606 units; less than half of China
- T & D network of 5.7 million circuit km – 3rd largest in the world



Installed Generation Capacity

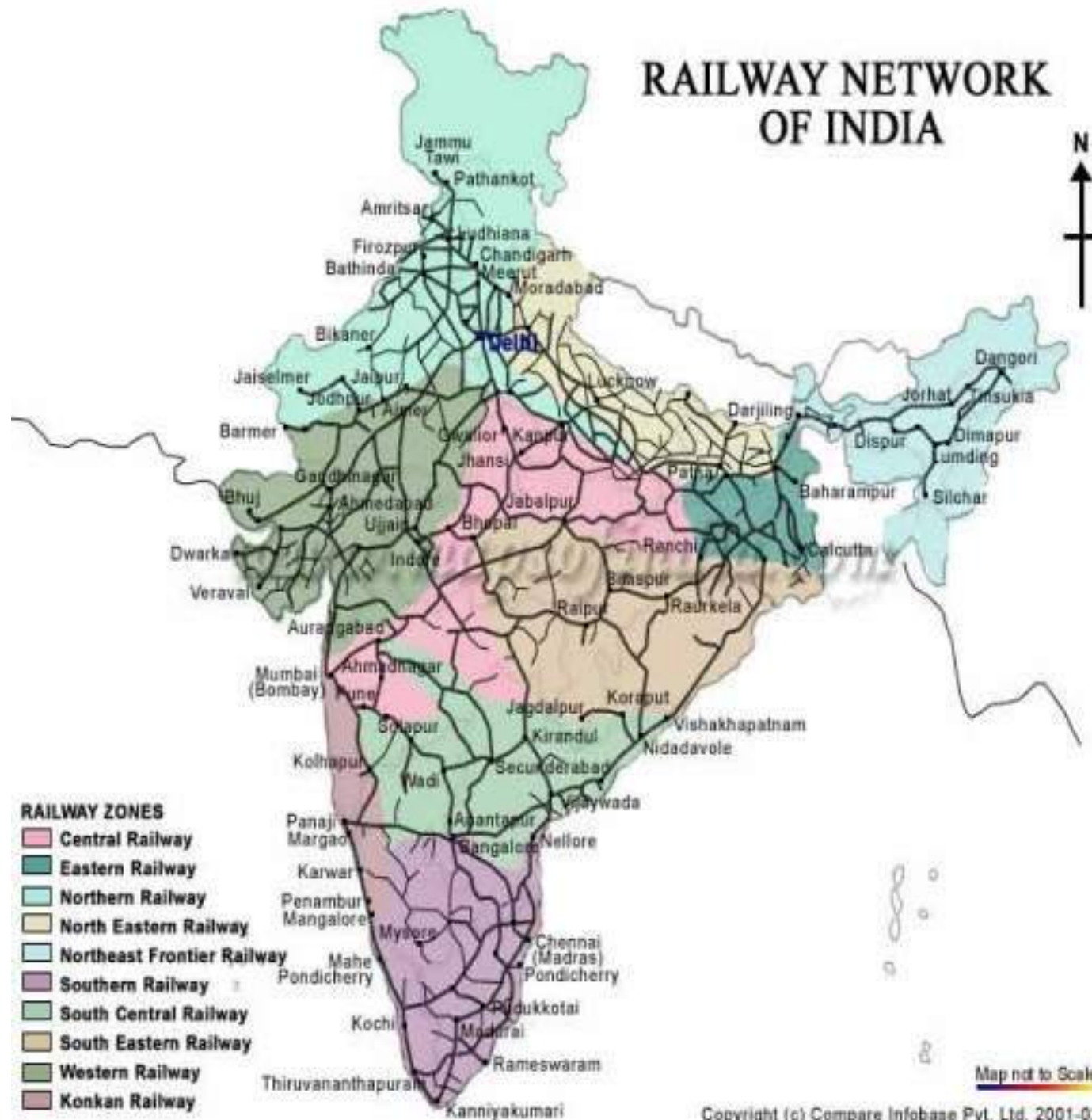
Structure & Size

- Urban population – 300 mn (30% of national population)
- Growth – 5 times in the last 50 years



- Urban Administration is decentralized to Urban local bodies

RAILWAY NETWORK OF INDIA



Copyright (c) Compare Infobase Pvt. Ltd. 2001-02

Source: Prof. K.C. Iyer, IIT-Delhi

MAJOR & INTERMEDIATE PORTS OF INDIA



Source: Prof. K.C. Iyer, IIT-Delhi

Structure

- India has extensive road network of 3.3 million km – the largest in the world (road density 1 km per sq km)
- Highways/Expressways constitute about 66,000 km (2% of all roads) and carry 40% of road traffic
- Government of India (GoI) spends about US \$ 4 billion annually on road development
- Roads carry about 61% of freight and 85% of passenger traffic

Source: Prof. K.C. Iyer, IIT-Delhi

Size

- National Highways (NH) -total length of 65,569 km
- National Highway Development Programme (NHDP) - A total investment of USD 54 bn up to 2012
- Ongoing Major Programmes under NHDP
 - Golden Quadrilateral (GQ) four-laning- 5,900 km connecting Delhi, Mumbai, Chennai and Kolkata
 - North-South East-West (NSEW) corridor - 7,300 km to be completed by December 2009



Source: Prof. K.C. Iyer, IIT-Delhi

India Background: Current IT Infrastructure

- Power
 - Present shortage: 8 %, Peak demand shortage is 11.6%
 - Regional imbalances – surplus in East, deficit in North, South
- Telecom
 - India's current teledensity is 17 which means there are 17 main telephone lines per 100 population.
 - Currently there are 190 million telephone connections in the country.
 - The urban telephones density is as high as 35-40 where main businesses are situated.
 - Similarly there are 8.5 million Internet subscribers and 2.05 million broadband users. This gives about 10.55 million Internet connections. The actual internet users will be far more and restricted by number of PCs alone

Current Status: Indian Telecom

- Tele-density : 17
- Fixed + Mobile : 190 m
 - Growth : 50% per annum
- Wire line : 40.5m Marginal decline
- Wireless : 150 m
 - Growth : 50%
- Market share CDMA :30% GSM : 70%
- Internet Subscribers : 8.5m (Annual growth of 26%)
- Broadband Subscribers : 2.05m (Annual growth 50%)

Source: Mr. S.B.Khare, D.D.G. BSNL, New Delhi, India



Background

- Importance of science and technology for meeting economic and social needs of a country
- R&D spend
 - USA : \$276 billion (2002)
 - India : Rs 22,000 crore (2004-05)
- Percent of GDP
 - USA: 2.71 % (2002)
 - India: 0.78 % (2004-05)

Source: Dr. Jyoti S. A. Bhat, DSIR

Background

- R&D as a percent of GDP:

	<u>2000</u>	<u>2002</u>
Israel:	4.43%	5.11%
Sweden:	3.78%	4.27%
Finland:	3.37%	3.52%
Korea:	2.65%	2.91%
Japan :	2.98%	3.11%
Singapore:	2.12%	2.25%
Germany:	2.53%	2.64%
China:	1.00%	1.23%
Brazil:	0.87 %	1.04%

Source: Dr. Jyoti S. A. Bhat, DSIR



Country wise R&D expenditure (2000-02)

Country	R&D exp (US \$ mill)	R&D % of GNP	Per capita R&D exp (US\$)	Industrial R&D (2000:US\$ mill)
Brazil	4623	0.87	22.55	1736
China	10844	1.00	12.15	6530
India	2303	0.59	3.53	642
Israel	2841	2.78	755.91	1588
Korea	12249	2.65	288.50	9196
Taiwan	6326	2.05	284	3964

Source: UNESCO

Business World Economic Outlook

Source: Business World, India, April, 2007

BW-Thomson Financial PE Roundup

April The Indian private equity market saw 43 deals worth \$799.97 million as on 17 April 2007. The 1-17 April fortnight saw four deals worth \$63.52 million.

Asia deals

INVESTOR	TARGET	TARGET NATION	DEAL SIZE (\$ MN)
ChrysCapital, UTI Venture	Spanco Telesystems	India	28.32
Goldman Sachs, others#	Slash Support	India	25.00
SAIF Partners, others ^	One97 Communications	India	8.00*
Sequoia Capital	Apnaloan	India	2.2
GIC Special Investments	Hawks Town Corpn	Japan	NA

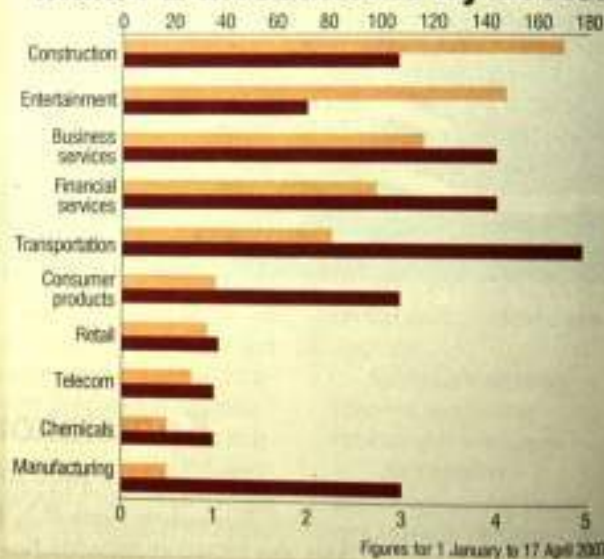
#Sierra Ventures and SAIF Partners; ^ Silicon Valley Bank
Figures for 1-17 April 2007

*Source: media reports

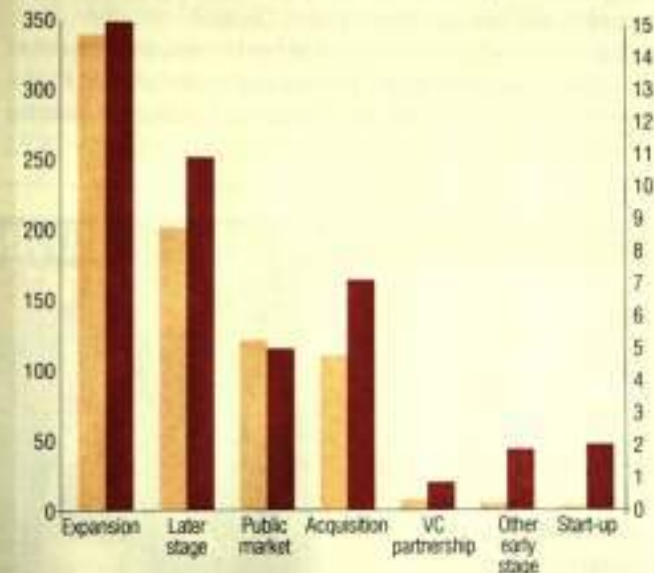
Asia PE markets



India PE investments by sector



India PE investments by stage



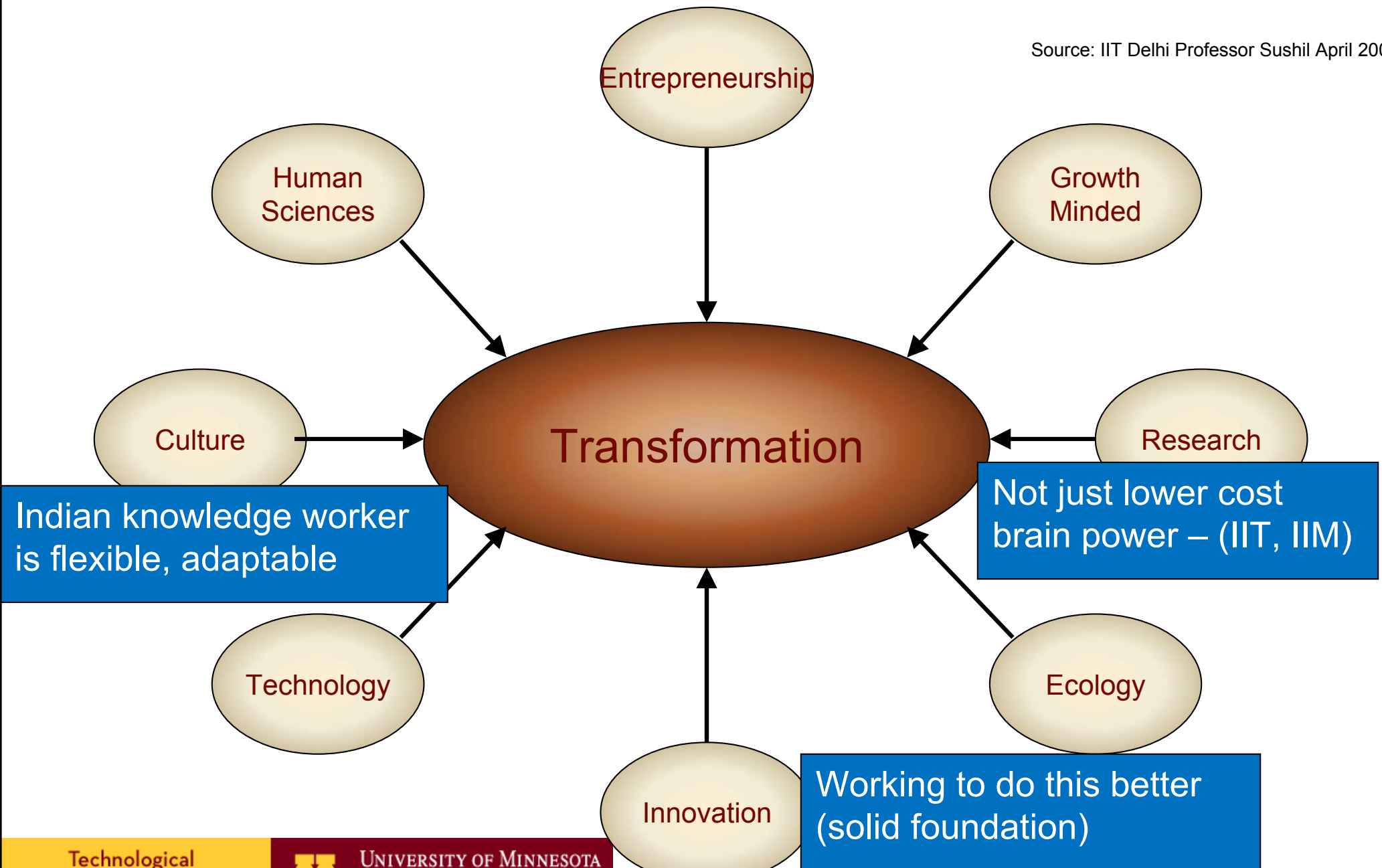
Sum invested is actual money taken down or disbursed to portfolio companies. PE deals are classified as investments where the investor is a PE firm. The above tables do not include investments made by angel investors, hedge funds, trusts and corporate investors. Such investors are taken into account only when they have invested alongside PE firms.

Log on to www.businessworld.in for the complete list

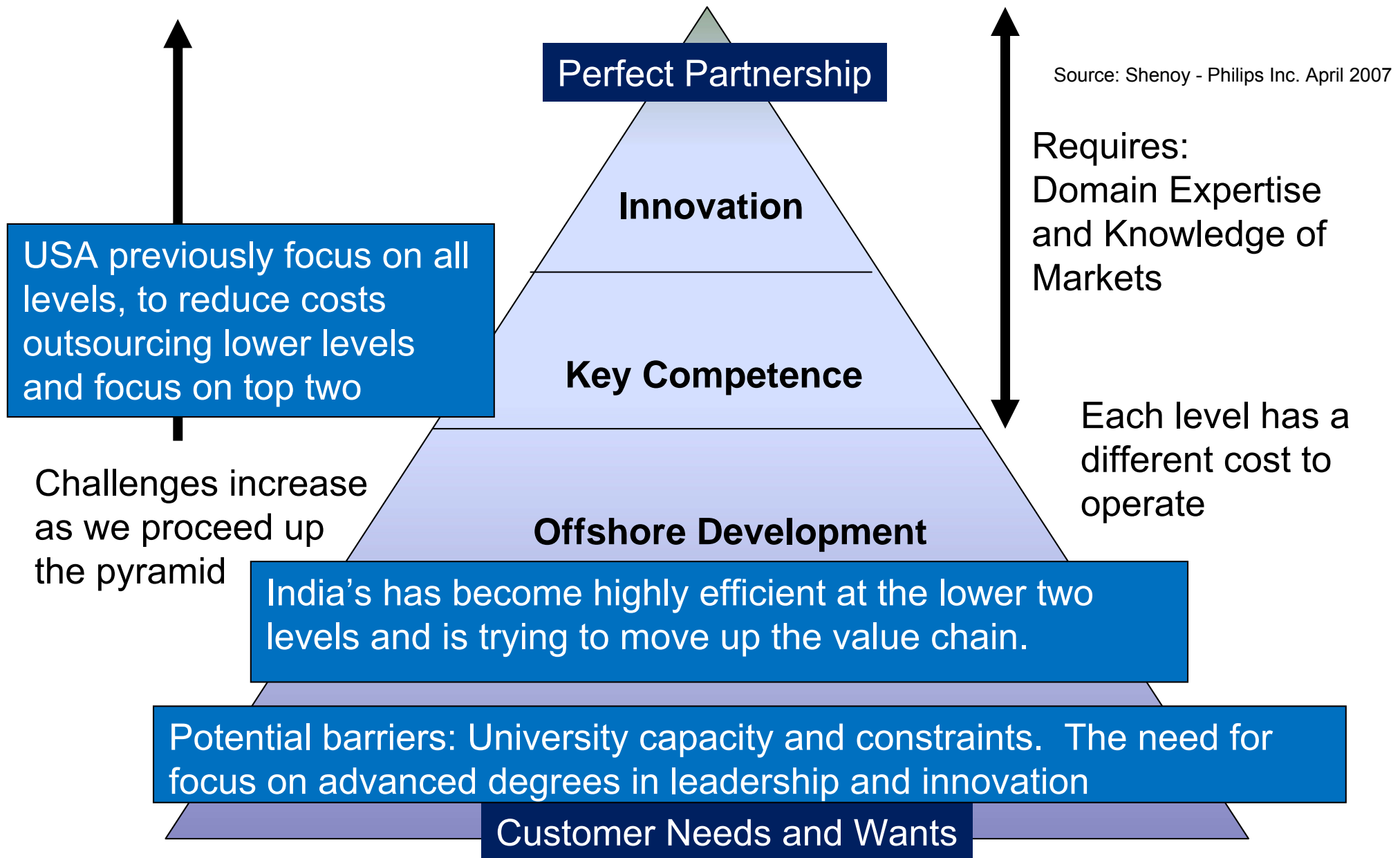
Global Companies are starting to take notice of India,
Private Equity Investment growing

India's Global Transformation

Source: IIT Delhi Professor Sushil April 2007



Partner Maturity Index

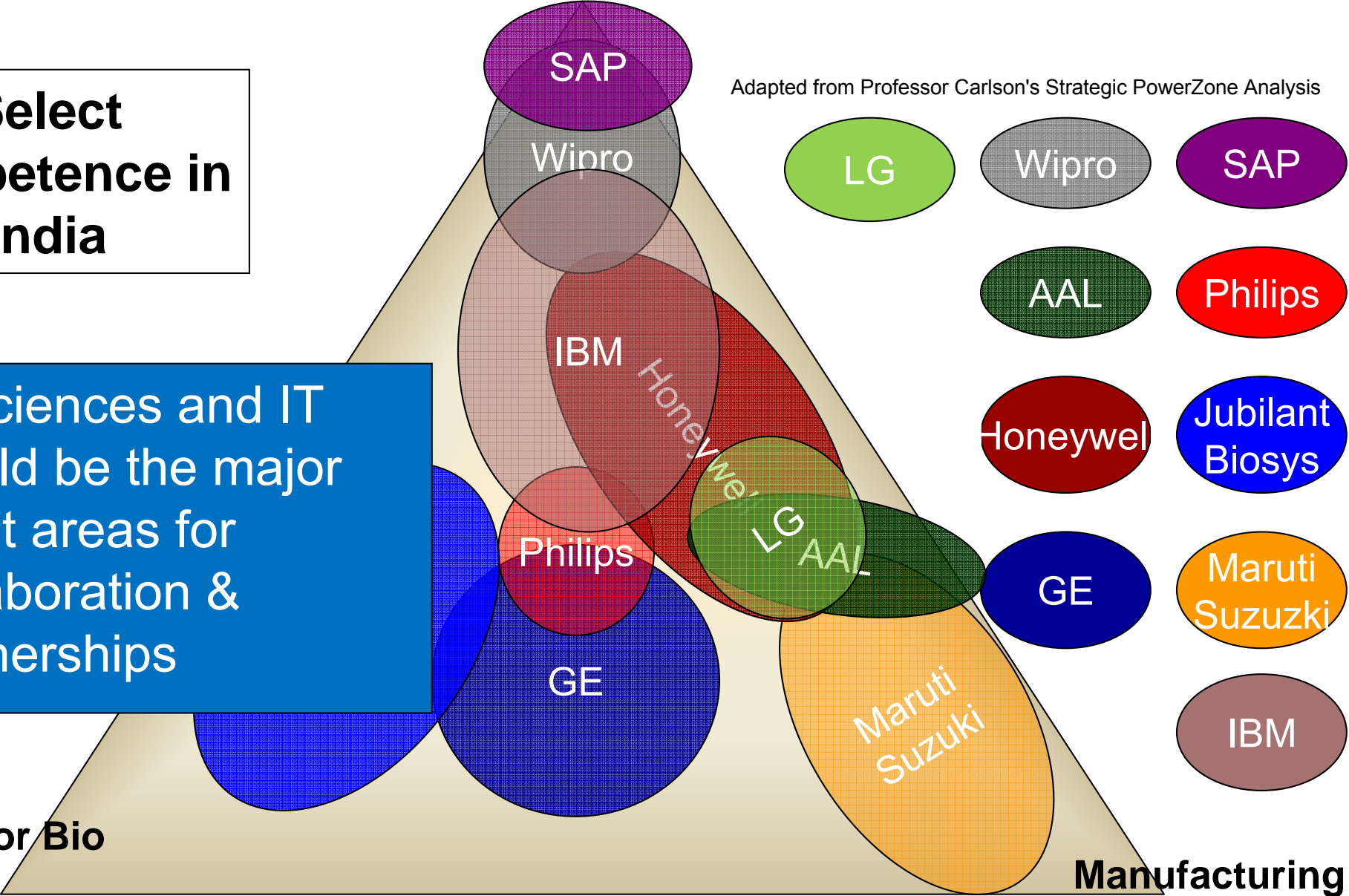


Information Sciences

Select Competence in India

Biosciences and IT should be the major thrust areas for Collaboration & Partnerships

Adapted from Professor Carlson's Strategic PowerZone Analysis



Physical or Bio Sciences

Manufacturing

Company Overview

Company	Leading	Opportunity (with MN)
Jubilant	Bioinformatics and Data Warehousing	Collect patient medical history
Phillips	Application Development Mobile Phone Software	Partnering and Collaborating with MN companies for imaging technology
Honeywell	Linux and Java based Systems & Controls	Security\Communications and medical diagnostics
SAP	Sales Force Automation (CRM) and Logistics (ERP)	Partner with MN based SME to assess all-in-one system
GE	Medical Imaging & 3D modeling	Collaborate with MN based medical companies
Maruti Suzuki	Manufacturing Process, Homegrown ERP	None
Wipro	IT Enabled Development, Knowledge Management	State government IT outsourcing to reduce cost

Technology Leverage for Minnesota

<u>Sector</u>	<u>IT</u>	<u>MEDICAL</u>	<u>UNIV</u>	<u>GOV'T</u>			
India Gov't	Jubilant Biosys •MN Opportunities •Huge potential for bioinformatics data mining •Like MN, strong Biomedical landscape •Low cost bio/pharma R&D			X	Wipro •MN Opportunities: •Looking to open small technology centers near US Universities to recruit top talent and evaluate technical trends		
Jubilant							
Phillips							
Honeywell				X			
SAP							
GE		X	X	X			
Maruti Suzuki	X						X
SAP •MN Opportunities •Partnering with MN companies to enhance SME software			X	X			
			X				
AAL	X						X

IT Ties Between Minnesota and India: Goal

- Using IT, increase the opportunity for the lower class to attain better employment
 - Increase literacy rate through wider availability of primary education
 - Develop more opportunity for reputable secondary education
- Expose opportunities for MN



Vs.



Challenges

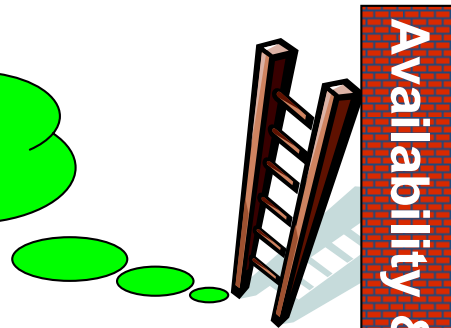
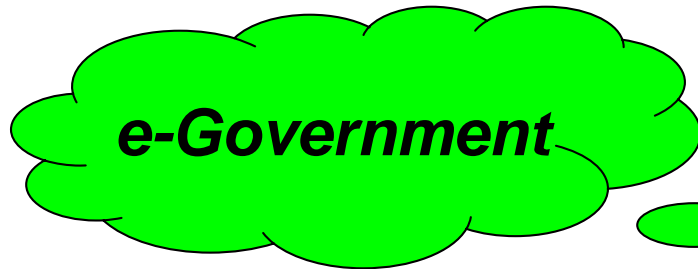
- Infrastructure limitations to provide full IT coverage to India
- Need funding to continue to expand both IT systems and infrastructure
- High attrition and a limited pool of qualified candidates; large pool unqualified candidates
- Create the perception and reality that India is progressing in technology – attraction of more technology
- Strict Indian government policy with respect to education

The IT Ladders in India

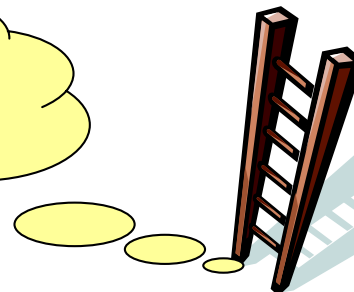
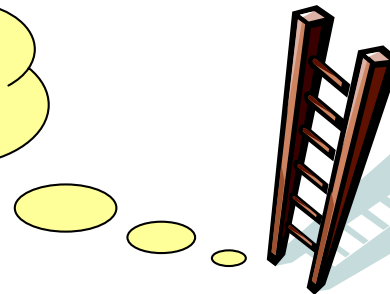
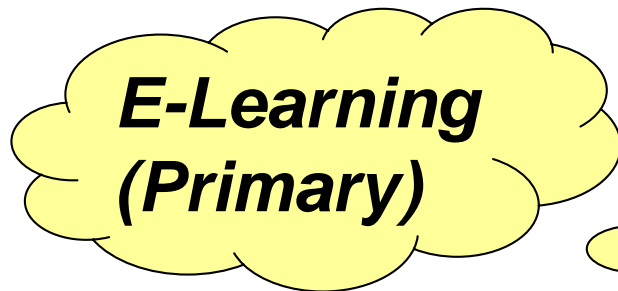
Opportunities

Wall of challenge

Benefits



Availability & affordability for the people

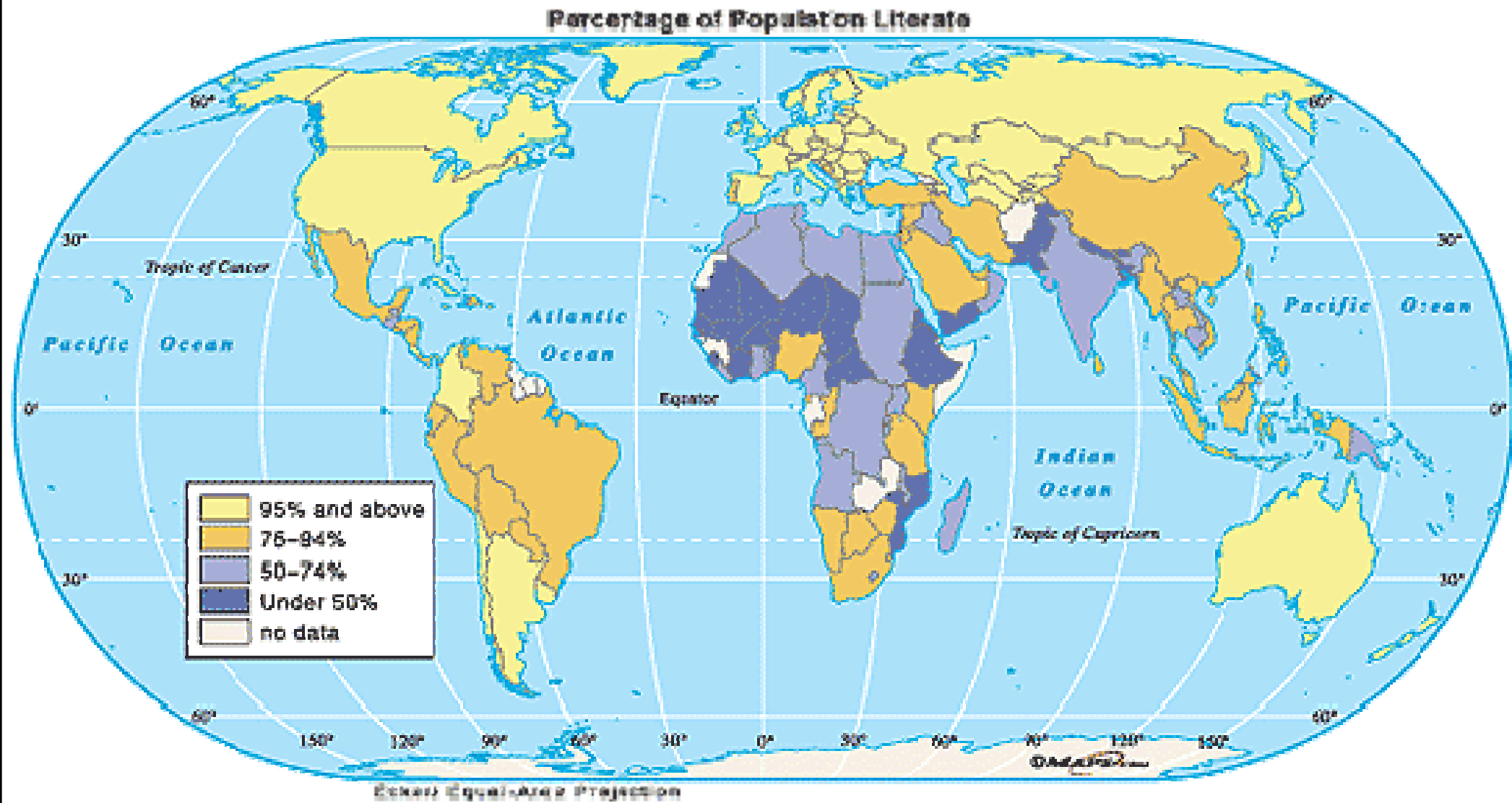


- v Workaround for limited transportation infrastructure
- v E-Gov helps expand IT availability to enable ladders 2 & 3
- v Increased literacy rate
- v Help close the gap between classes
- v Increased qualified labor pool (competitive advantage)

State of Education

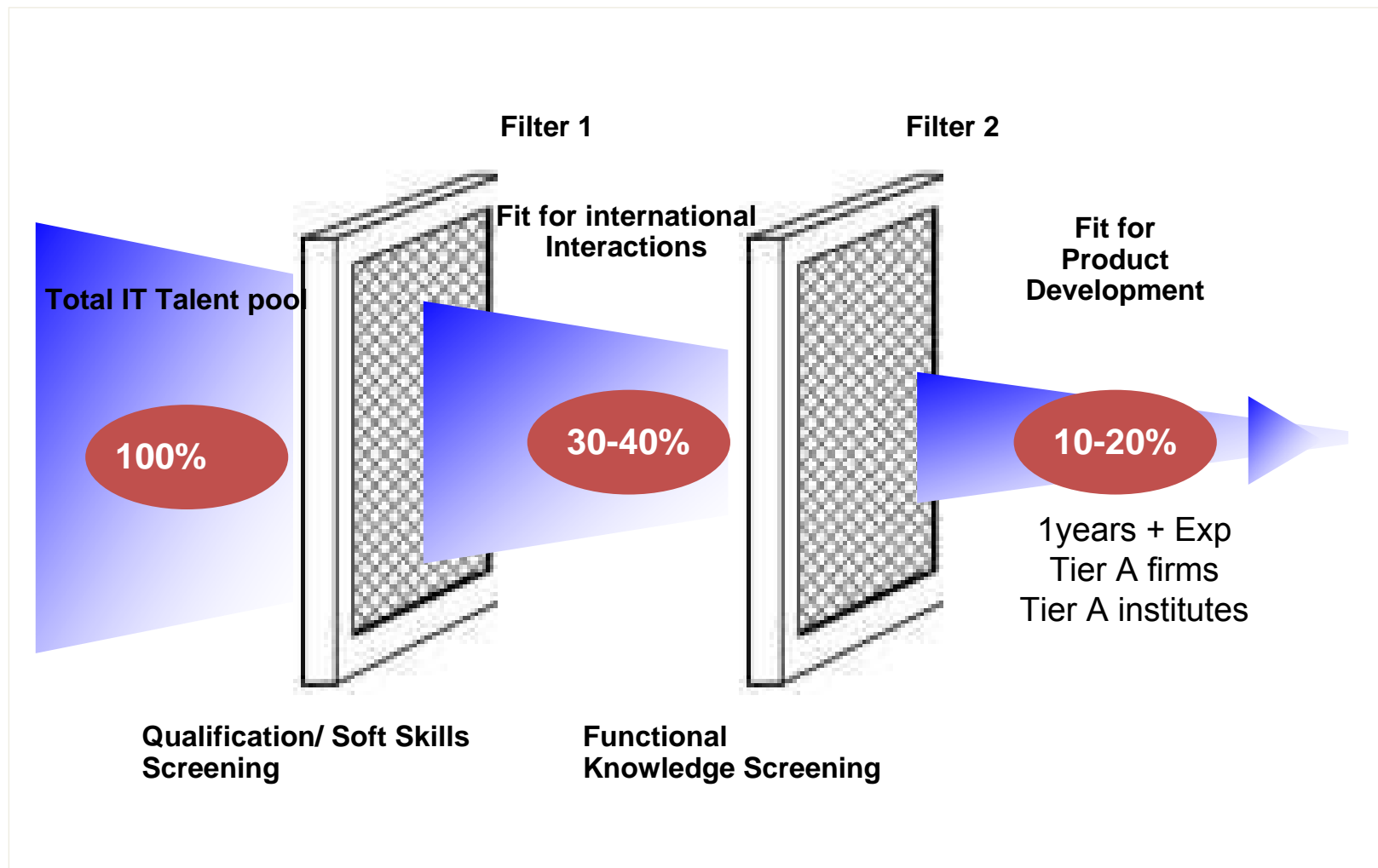
- Primary education
 - Private is very strong & expensive
 - Government schools are more affordable
- Secondary Education
 - Select Secondary Institutes are very strong (IIT, IIM, IISC)
 - Extremely difficult to gain admittance into top universities (IIT, IIM, IISC)
 - Other universities are either not accredited or not considered reputable

Percentage of Population Literate



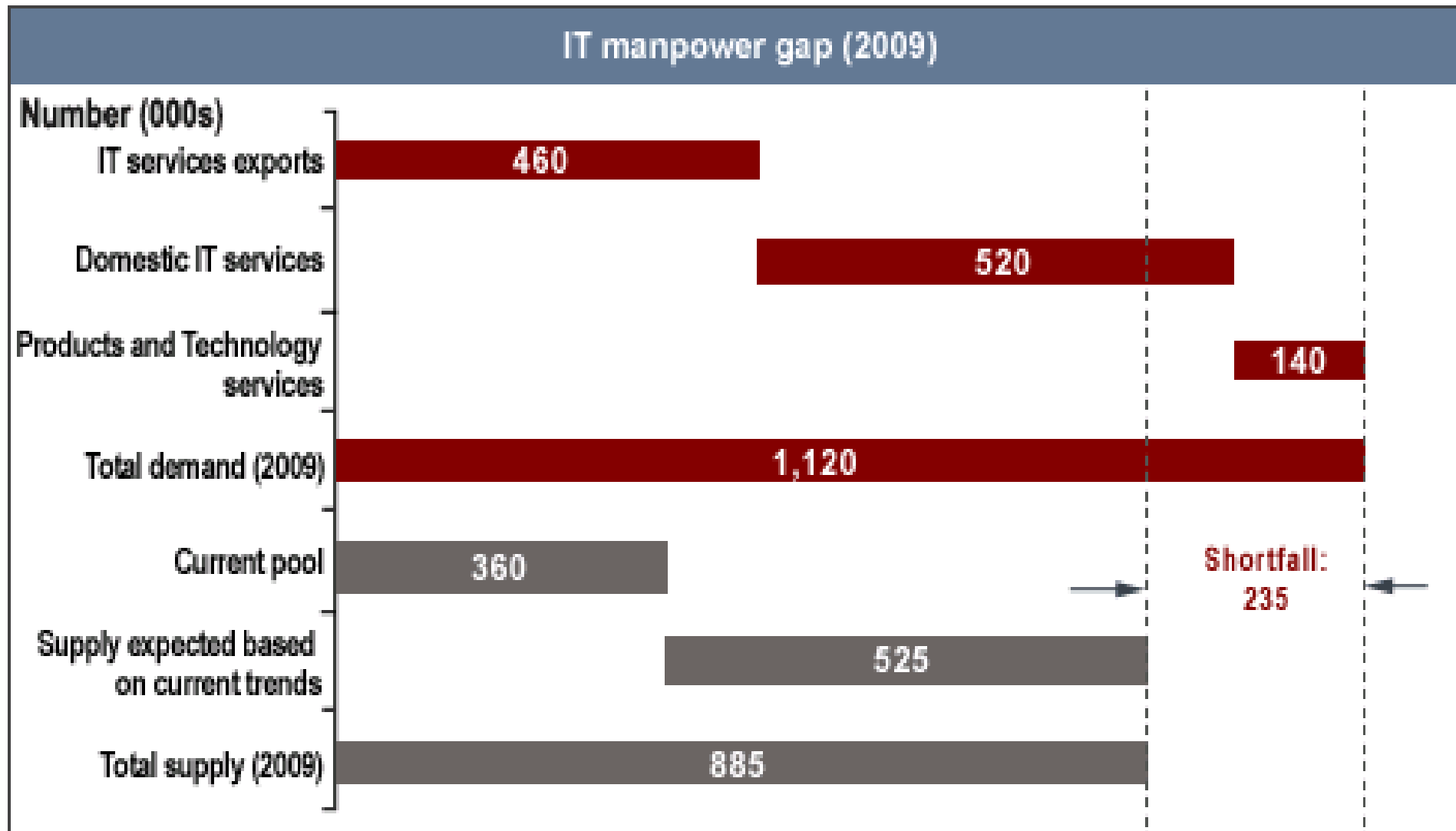
Needs and Opportunities for IT in India

The Relevant Pool for Product Firms is Smaller



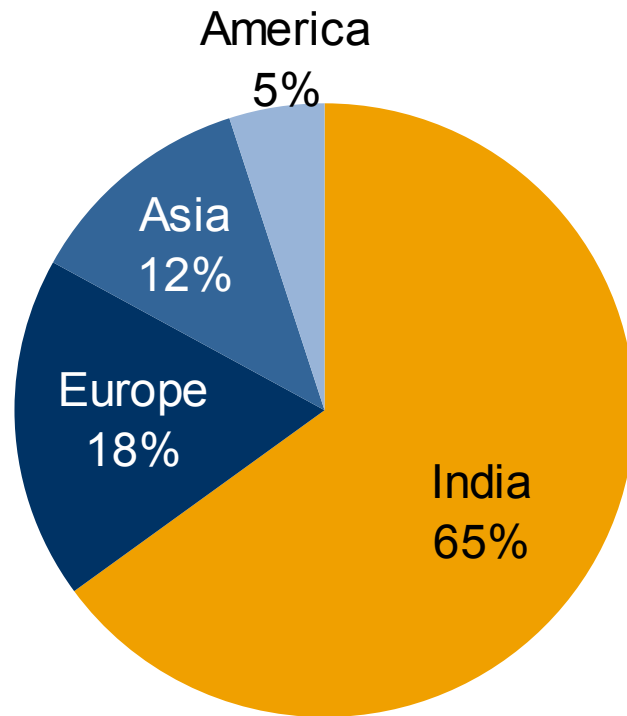
Source: SAP, Bangalre, India

Needs and Opportunities for IT in India

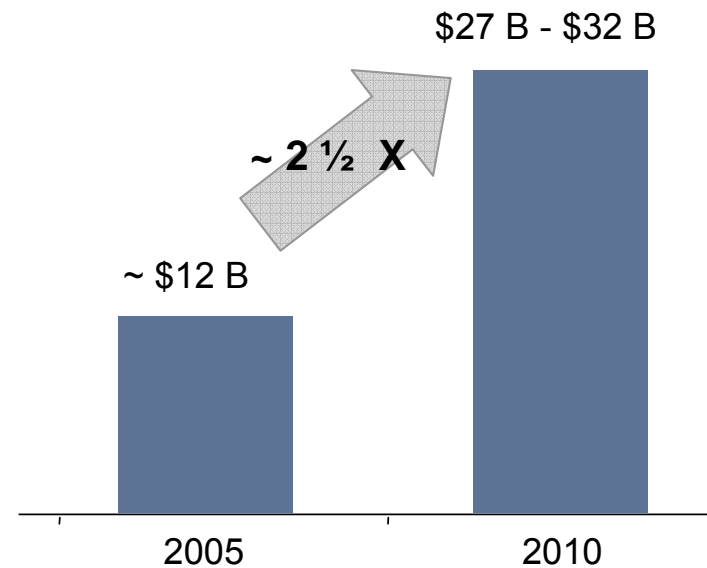


Note: Manpower supply numbers are based on extrapolation of current trends related to growth in educational institutions, attendance rates out-terms and labour participation as well as employment preferences. Source: Institute of Applied Manpower Research. NSSO. NASSCOM. KPMG. 2003.

Needs and Opportunities for IT in India



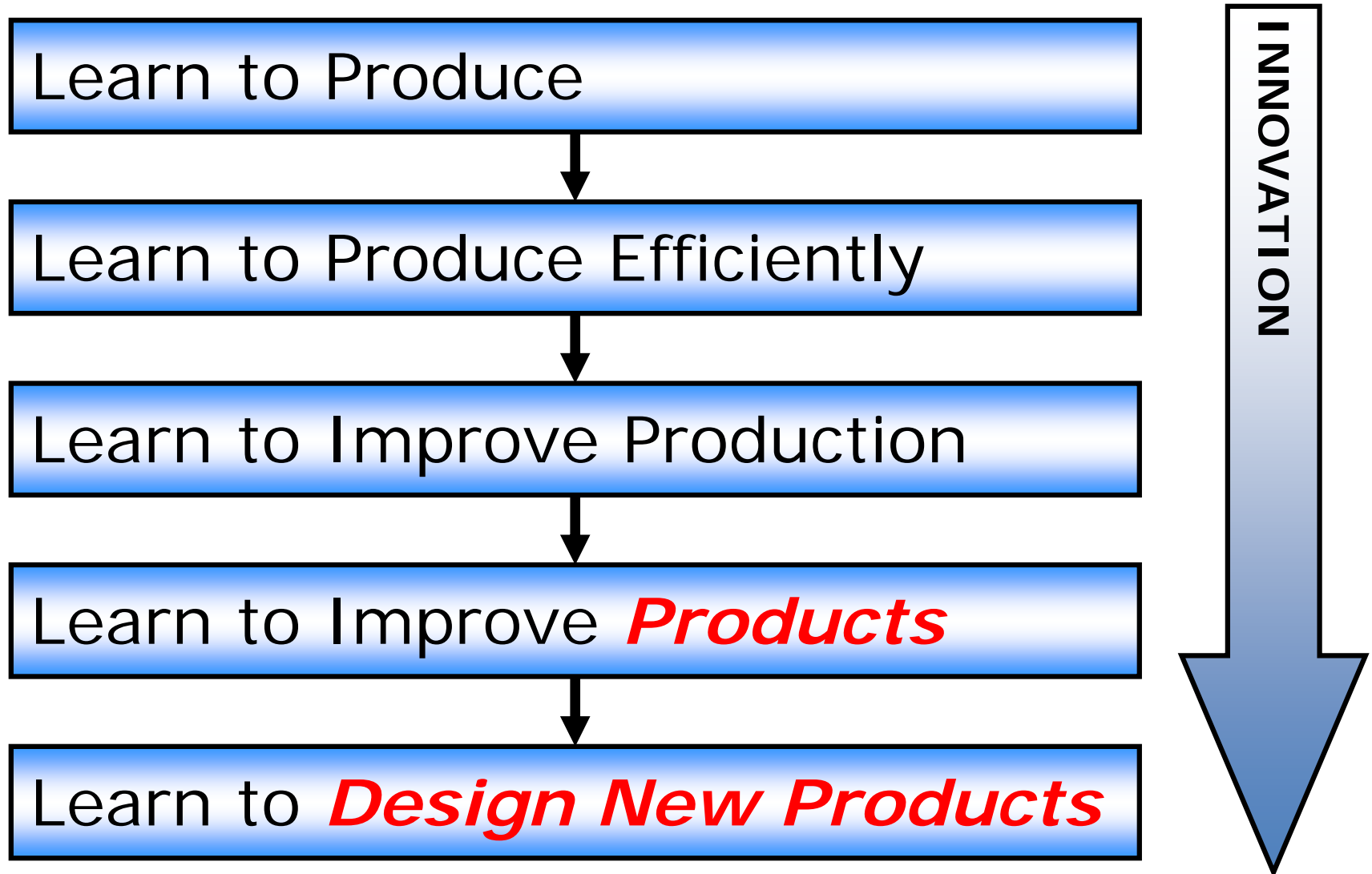
Global IT Off Shoring Market



India IT Sector is poised to grow

Source: Nasscom McKinsey Report '05

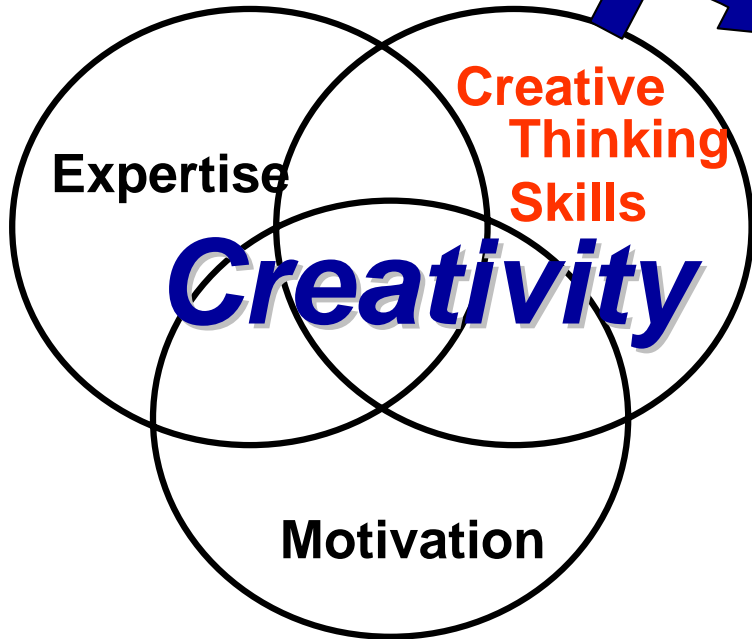
India IT Capability Evolution



Source:
Forbes & Wield,
2002

IT Technology Development

Innovation



Constructive controversy
Networking
(Super brokers)
Doors for creative ideas

<u>Item</u>	<u>India</u>	<u>US</u>
Diversity of expertise	H	H
Veteran to new team members	M	H
Sense of fun & play	M	M
Include outsiders	H	M
Diversity of thinking styles	L	H
Small project teams	L	H

Low, Medium, High

Teresa Amabile *HBR* Sept '98

India Education Policy

- Accreditation for universities in India are required by law unless it was created through an act of Parliament.
- Without accreditation, the government notes "these fake institutions have no legal entity to call themselves as University/Vishwvidyalaya and to award 'degree' which are not treated as valid for academic/employment purposes."
 - The [University Grants Commission Act 1956](#) explains, "the right of conferring or granting degrees shall be exercised only by a University established or incorporated by or under a Central Act carlo bon tempo, or a State Act, or an Institution deemed to be University or an institution specially empowered by an Act of the Parliament to confer or grant degrees. Thus, any institution which has not been created by an enactment of Parliament or a State Legislature or has not been granted the status of a Deemed to be University, is not entitled to award a degree."

Takeaways

- E-learning: expansion of current market for computer based primary education
- Larger labor pool could reduce the wage inflation
- Making e-Government a priority will increase the rate of telecommunication infrastructure development
- Develop student exchange programs with India Institutes to learn creative thinking styles



Executive Summary

- Information Technology (IT) is no longer the leading Industry in Minnesota
- MN in-house IT still drives success
- MN leverages India to spark resurgence in IT
- India can help to globalize Minnesota companies
- India leverage MN strengths
 - Healthcare
 - Education

Lessons Learned: India / MN SWOT

	India	Minnesota
Strengths	<ul style="list-style-type: none"> ● Young median age (24.9 years old) ● English speaking ● Highly educated ● 8.5 % GDP growth 	<ul style="list-style-type: none"> ● Strong base of IT Professionals in major MN companies (e.g. IBM, Oracle Retail, Best Buy, Target, Accenture, 3M, etc...) ● Excellent Universities: Computer Science and Technology Programs
Weaknesses	<ul style="list-style-type: none"> ● Infrastructure ● 15% employee attrition rate ● Under-utilized talent pool ● Five year plans ● Politics 	<ul style="list-style-type: none"> ● Lower enrollment in Computer Science programs due to bust cycle of early 2002 ● Limited local market - Saturated ● Cold Winters ● Not a leader in IT Innovation
Opportunities	<ul style="list-style-type: none"> ● Become the World's Silicon Valley ● High Foreign Direct Investment (FDI) to develop new businesses - Innovation ● Partner with Minnesota Universities/colleges to train future Indian educators. 	<ul style="list-style-type: none"> ● Partner with local high school to encourage and provide roadmap to University IT programs ● Align and partner with other universities (IIT And IISc) to promote global growth of technologies
Threats	<ul style="list-style-type: none"> ● Rising labor costs ● Unstable neighbors ● IPR 	<ul style="list-style-type: none"> ● Market fluctuation in demand based on economic cycles (boom/bust) ● High offshore competition for IT jobs

Minnesota – India Collaboration Opportunities

Company	Leading	Opportunity
Thomson Reuters	Software, information, communication, BI, and data management	Accumulate and organize Indian legal, engineering, healthcare, and technology patent documents. Facilitate employee communications and retention.
Digital River	E-commerce and marketing	Bollywood, Trusted software distribution
Vital Images	3-D images of the heart and other organs	Improve burgeoning healthcare industry
Lawson Software	ERP software and service solutions	Sales to Indian service and manufacturing sectors.
Wipro, Infosys, Tata, HCL, etc...	IT Enabled Development, Knowledge Management Systems	MN outsourcing to reduce cost – India IT outsource to MN for resources Sponsorship/Partnership

Opportunities

Opportunity	What should be done?	Who?	How?	When
IT in business	India collaborate with Minnesota companies to manage information storage and retrieval.	Thomson Reuters and Indian companies	Set up information repositories and the systems to access and distribute.	Now
IT in healthcare	Increase collaboration between doctors and patients.	Hospitals, clinics, Vital Images.	Create a communication system for learning, sharing and diagnosis.	1-3 years
IT in communications	Collaborate to create innovative ways for developing the communication framework.	Indian companies and Digital River	Partnering to create software and media delivery.	1-5 years
IT Outsourcing	Use the experience in IT in MN and India to outsource resources to each other to expand their markets.	India Companies like: Wipro, TCS, Infosys, MN Companies like: Analysts International, Geek Squad	Leverage IT resources through partnerships and exchange programs.	1-5 years



Recommended Moves

Threat	What should be done?	Who?	How?	When
Employees: Quality and retention	<ul style="list-style-type: none"> •Increase talent pool in both India and Minnesota •Create attractive employment islands away from competitive centers to reduce attrition •Create employee centric workplace (HCL) •Improve promotion and create challenging work •Companies move to tier II cities for IT growth (Mysore) 	IT organizations	Internal instruction Partner with IIX	Now
Spark Innovation	<ul style="list-style-type: none"> •Format tests based on creativity and artistic ability • Promote VCs and Entrepreneurs 	IT organizations Universities - MOT	Promote Creativity	1-3 years
Infrastructure	Government and FDI enhance infrastructure to sustain growth – Supply Chain, BroadBand/Wireless, Water, Health Control	Government, Domestic and Foreign Companies	Policies for long term growth	1-10 years



Recommended Moves

Threat or Opportunity	What should be done?	Who?	How?	When
Rising Labor Costs	Create higher value add to keep FDI	IT organizations	Innovation s, R&D, Top Education Resources (ex: Business by Design)	3-10 years
Telecommunications	Use IT to enable users with information for increase in Mobile users	IT Organizations Mobile Providers	Provide data content based on niche users	3-10 years
Increase Globalization	Grow companies internationally to spread risk	IT organizations	Expand into Asia, Europe, NA and SA	5-10 years

References

- <http://www.american.edu/initeb/zs2946a/Infrastructure.htm>
- SAP presentation-- Lopamudra Bhattacharya VP, Marketing & Communications
- http://education.nic.in/drft_ict_schools.asp
- Science and Technology Macro Perspectives— Professor DK Banwet
- <http://www.dot.gov.in/>
- Overview of India's Infrastructure— Dr. K.C. Iyer
- Telecom in India presentation— S.B. Khare
- http://en.wikipedia.org/wiki/Education_in_India#Distance_education
- <http://www.thehindubusinessline.com/2004/07/14/stories/2004071402590300.htm>
- <http://news.uns.purdue.edu/UNS/html3month/2007/070112RutledgeIndia.html>



International Management of Technology (MOT) Project

India - Minnesota Opportunities in Renewable Energy



Executive Summary

- India has a significant amount of renewable projects. Focus is needed.
- Opportunities exist between MN and India in the following renewable energy arenas:
 - Wind Power
 - Biomass (Biogas, Biofuels, ...)
 - Hydro power
 - Water purification/filtering/recycling
 - Research
 - Manufacturing



Observations

- Multiple technologies required (no one solution)
- Small, medium, and large scale initiatives underway
- Infrastructure challenges & dependency
- NGOs involved in monitoring progress
- FDI requires local partnership



Buffalo Ridge, Minnesota (USA)



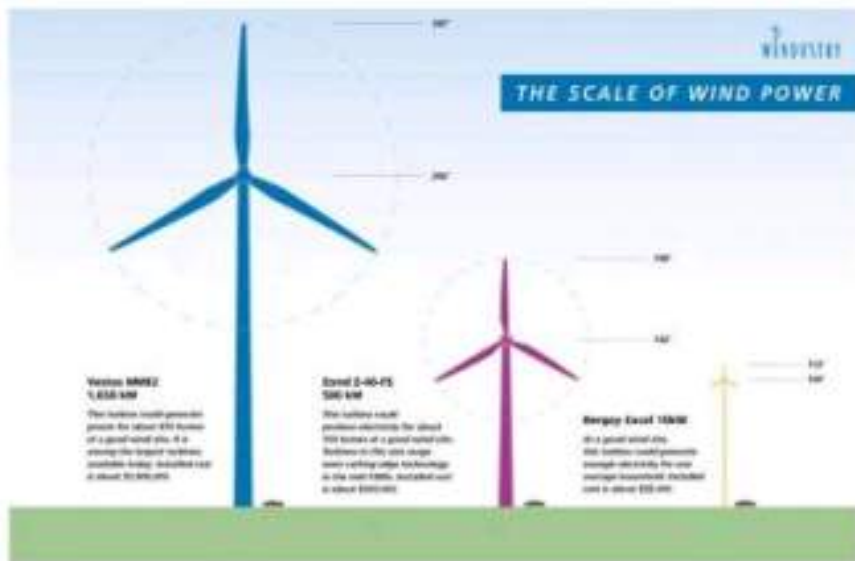
Univ. of Minnesota, Morris (USA)

India / MN Renewable Energy SWOT

	India	Minnesota
Strengths	<ul style="list-style-type: none"> ● Expanding technology base ● Favorable policy towards renewables ● Growing tax base ● Large workforce 	<ul style="list-style-type: none"> ● Statewide mandates for increasing use of renewables ● Strong movement toward green energy ● Successful history of renewable projects
Weaknesses	<ul style="list-style-type: none"> ● Challenging infrastructure ● Leary of outside involvement ● Lack of metering and regulation enforcement ● Lack of qualified personnel to maintain facilities 	<ul style="list-style-type: none"> ● Ethanol centric ● Limited solar opportunities ● Lack of cultural awareness
Opportunities	<ul style="list-style-type: none"> ● Increase public awareness ● High Foreign Direct Investment (FDI) can help develop new businesses ● Technology transfer opportunities ● Manufacturing and job creation 	<ul style="list-style-type: none"> ● Future JV opportunities ● Cost arbitrage manufacturing ● Support industries (ex. Water conditioning and filtering)
Threats	<ul style="list-style-type: none"> ● Competition for resources ● Increasing inflation rates ● Lack of strong infrastructure ● Lack of sustaining ecosystem 	<ul style="list-style-type: none"> ● Barriers to entry into Indian value chain ● Foreign relations issues

Minnesota Energy Sources

- Limited solar
- Good location for wind, hydro, and biomass renewable



India Renewable Energy Programs

- **Grid-interactive**
 - Biomass power (agriculture waste, manures)
 - Wind power
 - Small hydro
 - Cogeneration
 - Urban waste to energy
- **Decentralized**
 - Solar street lighting
 - Solar water heating
 - Wind pumps
 - Solar pumps
- **Village**
 - Family-sized biogas plants
 - Solar cookers
 - Home lighting
 - Solar lantern
 - Solar water Heating



Minnesota Players

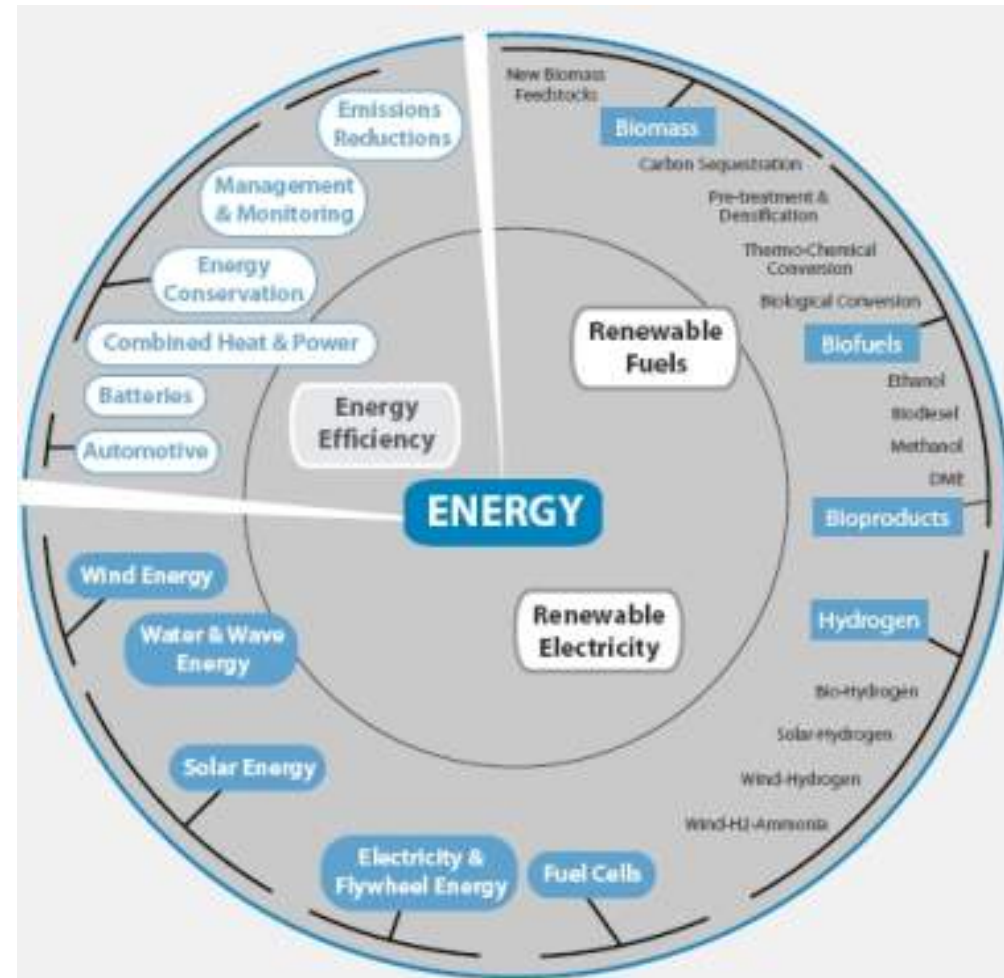
Company	Purpose	Opportunity (with India)
Wind Turbine Industries (Prior Lake)	Jacobs Wind Turbine	India Mfg, Village electrification,
Next Gen Power Systems (Pipestone)	Small wind turbine	India Mfg, Village electrification,
Donaldson (Bloomington)	Filtration	Biomass / Water / Sewage filtration; Clean Coal
Aeration Systems (Chaska)	Water purification	Infrastructure / Local water purification
Energy Conservation Products and Services (Duluth)	Solar space and water heating	Mfg in India – cost arbitrage
Rural Renewable Development Alliance – RREAL (Backus)	Solar space heating	Grassroots education and opportunity analysis in India
Solar Skies (Starbuck)	Solar water heating	Mfg in India – cost arbitrage
IREE – Univ. of MN (St. Paul)	Promote statewide economic development	Joint research programs with IIT- Sc
Wells Fargo (Minneapolis)	Banking and Financing	Consumer financing; Capital financing

Indian Players

Company	Purpose	Opportunity (with MN)
Suzlon	5th leading supplier for wind turbines	MN employer and leading wind turbine blade mfg
Tata BP Solar www.solarsv.com	Water heating Water Softening & Filtering	Partnership exists with Pentair (MN). Mfg in Goa.
OVN BIO Energy Private Ltd	Biomass Gasifier (Developed by IIS-Bangalore)	Bring technology to UofM And MN farms
Moser Baer Photo Voltaic Limited (MBPV)	PV cell manufacturer	Manufacturer of thin film PV ideal for rural applications both in MN and elsewhere
Orb Energy	Working to make solar power affordable and accessible to citizens of India	Distribution channels and service capabilities in place to test and market MN technologies in India
Delhi Transco Ltd. www.delhitransco.gov.in	State Transmission Utility -- Organizes solutions, suppliers, financing, rebates	Get on the list of approved mfgs and suppliers www.mnes.nic.in

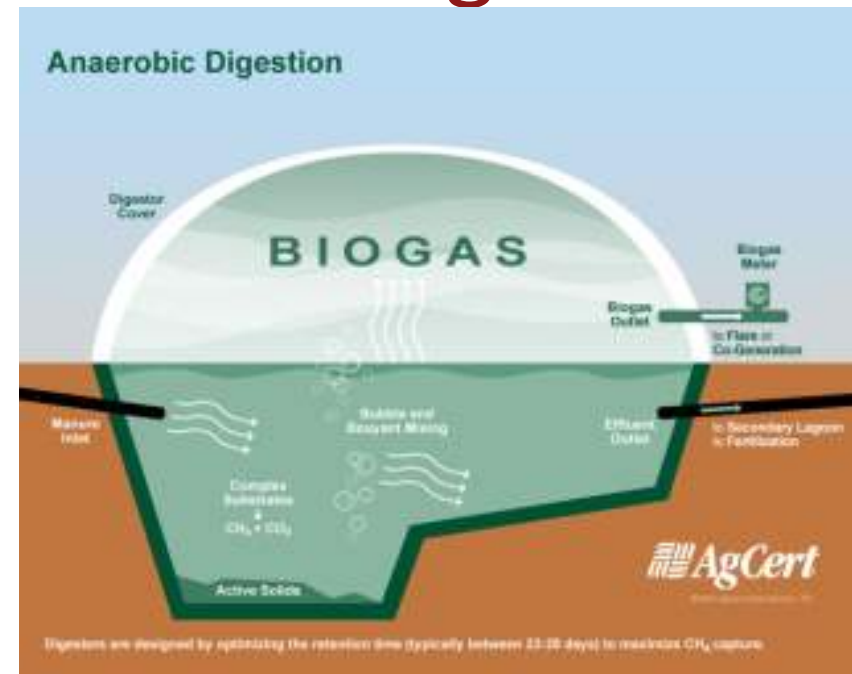
Initiative for Renewable Energy and the Environment (IREE at the University of MN)

IREE has funded 135 renewable energy related projects (\$19 million), involving nearly 400 faculty, research scientists and students at the University of Minnesota.



Opportunity Example: Anaerobic Digesters

- Move from satisfying individual to village level needs
- NBC Nightly News:
Crave Brothers Farm - WI
 - Outputs: Power, Fertilizer



Opportunity Example: Solar Water Heating

- Technology skills used:
 - Solar absorption
 - Heat transfer
 - Fluid conditioning and filtering
- Installed price: \$500
- Rebate: \$100
- Features:
 - Secondary loop to prevent calcium from hard water plugging micro channels



Short-term Moves

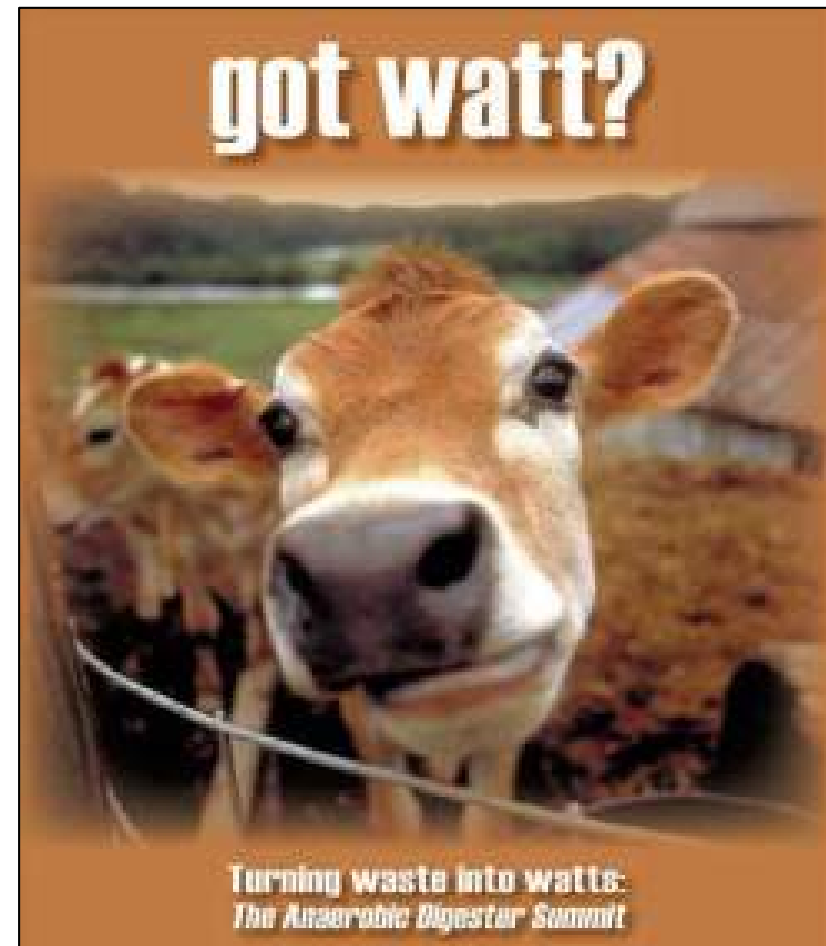
Recommendation	Who	What	How
Expand educational campaigns	NGOs, RREAL, Govt., Universities	Grass roots projects	Show and tell products, pilot projects
Local community action to build wind and solar generators	Solar clubs – India Windustry – MN	Build and integrate prototypes in rural communities infrastructure	Kits for education and demonstration
Research projects for renewable energy	IREE, IISc, Govt.	Strategic technology development, government incentives	Private R&D plus Govt. grants
Leverage multinationals that have integration / implementation capability	Honeywell / India Govt.	Joint research and implementation projects, memorandum of understanding between groups	Exchange programs, technology transfer
Technology transfer	US and Indian organizations	Energy Efficiency, Fuels, Renewable Electricity, Clean Coal, Biogas processing, MFG process	Consortiums Research Projects (Ex: Cellulolytic Enzymes, See MIT Tech Review – Apr 08)

Long-term Moves

Recommendation	Who	What	How
Develop renewable component manufacturing facilities in India	Private Industry, Govt.	Solar cells, biomass components,	Tax incentives, partnerships
Partner manufacturing opportunities with co-generation to promote both mfg and renewables	Govt., Industry	Promote partnerships and collaboration	Setup industry conferences, use government resources to seek partnerships
Consolidate and integrate renewable energy policies—focused vs. shotgun approach	India Govt.	Create a centralize department to assist investors	Create a one-stop shop for investors to get information for starting renewable businesses
Develop an attractive market for private enterprises to support / service projects	Govt.	Attract startups and small-medium size companies to invest, remove investment barriers; Maintenance and service providers	Raise awareness of India's opportunities, simplify INS/Visa requirements, setup free trade agreement
Measure the effectiveness of the renewable energy projects	NGOs	Continue monitoring of renewable projects	Publish monthly/quarterly results to inform and to show progress/regress
Develop ways to reduce costs of SPV applications for households	Industry, Govt.	Promote university and private research	Use local materials, local talents, reduce tariffs
Create a joint infrastructure/renewable policy	Govt.	Government incentives	Carbon credits in exchange for funding

Open Questions – Renewable Energy

- How do we make the renewable market attractive for private enterprises – ensuring equipment is maintained?
- How do you develop the incentives to change?



Infrastructure Development Opportunities



Opportunities

- Water supply
- Sanitation/Waste disposal
- Highways/Railroads/Mass Transit
- Cold chain
- Power generation
- Education system
- Tourism infrastructure (hotels, airports)

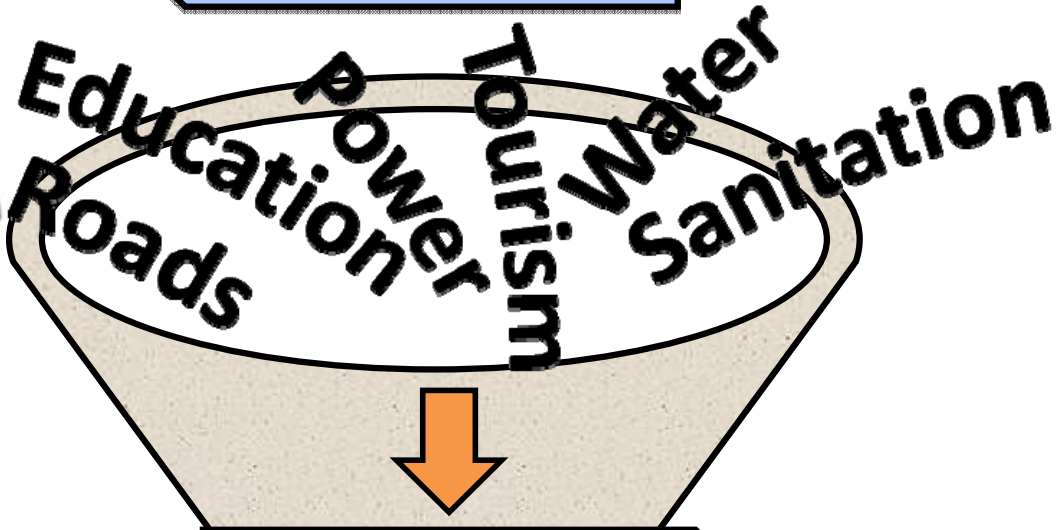


Challenges

- Many aspects of infrastructure are under developed
- **Population**
 - Bottom 2/3 of country's needs not being recognized
 - Bottom 2/3 of country holds tremendous voting power
 - Land acquisition issues
 - Cultural acceptance of mediocrity
 - Population may not be aware of importance of infrastructure
 - Every \$1 invested infrastructure returns \$5
- **Government**
 - Bureaucracy
 - From a Western perspective, need for a mutual cultural understanding, including dialogue on transparency, accountability, and political will to drive positive change



Opportunities



Technologies



OSMONICS



Northwoods Professional Group



CARLSONSM



UNIVERSITY OF MINNESOTA

Honeywell



DonaldsonSM
Filtration Solutions

HDR

3M

ONE COMPANY
Many Solutions[®]



Technological
Leadership Institute



UNIVERSITY OF MINNESOTA
Driven to DiscoverSM

Tourism



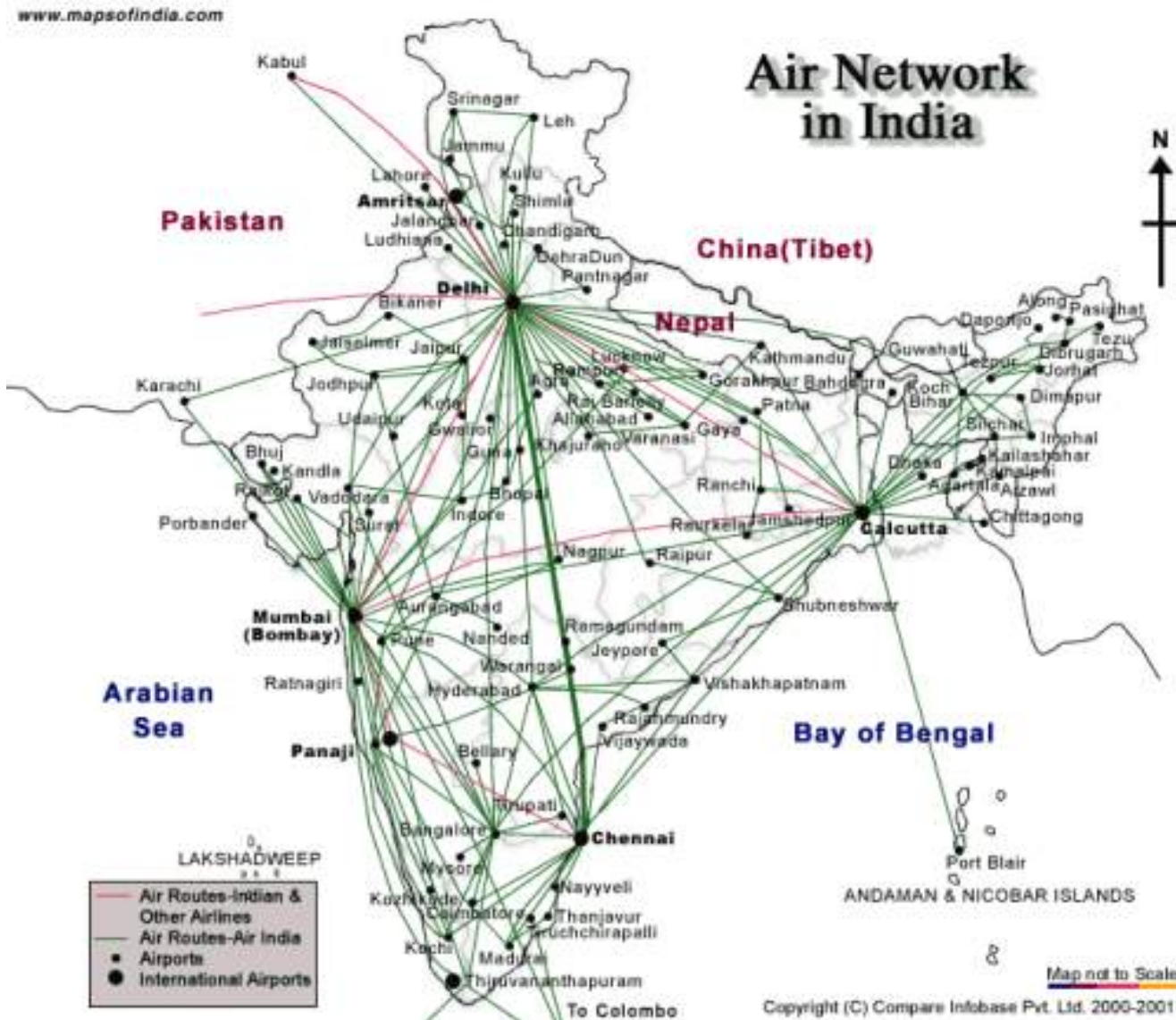
CARLSONSM

Radisson®

- 8 Radisson hotels
 - Chennai, Delhi, Goa, Jalandhar, Noida, Varanasi, Calcutta, Kumarakom
- No lower cost hotels
 - Should develop Taj Express hotel chain specifically for India tourism market



Tourism



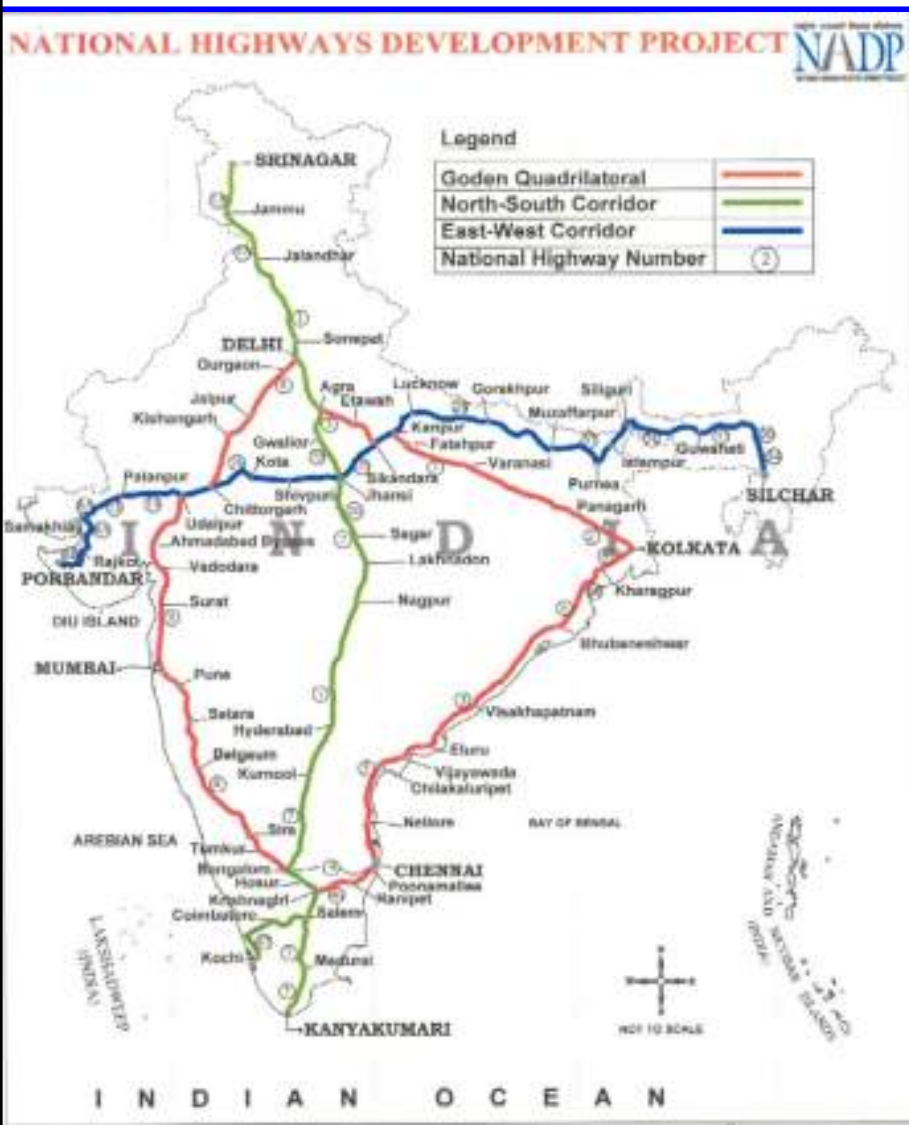
Tourism



- Should provide direct flights to India
 - Continental provides Newark to Delhi
- Develop tourism packages using new partnerships
 - Hotels, restaurants, entertainment centers (parks, music, museums)

Highway/Road Construction in India

* From the Report "Financing of the NHDP" Published by Government of India



Source: <http://www.nhai.org/gqmain1.htm>

National Highway Development Project (NHDP)

- ~ US\$ 50 billion to be awarded on concessions/contracts by 2012*
- BOT (Build, Operate, and Transfer)

Policy

- 100% FDI under the automatic route is permitted for all road development projects

Technologies

- Prefabricated Bridge Elements and Systems
- Pavement Materials and Construction Technology (Asphalt, Concrete, Materials)

Companies

- US: Bechtel, Flatiron (Flatiron-Mason Joint Venture is St. Anthony Falls (I-35W) Bridge in Minneapolis), Hoover Construction Company (Based in Minnesota)

India: Hindustan Construction Company, Larsen & Toubro, GMR Group, GVK

Water Treatment

- Problems: disease, pollution, looming water shortages.



- Solutions: conservation and stewardship, municipal water treatment, industrial waste treatment.



- Minnesota technology partners:

Membrane and cartridge filters and systems

Ion exchange resins

Process chemicals



OSMONICS



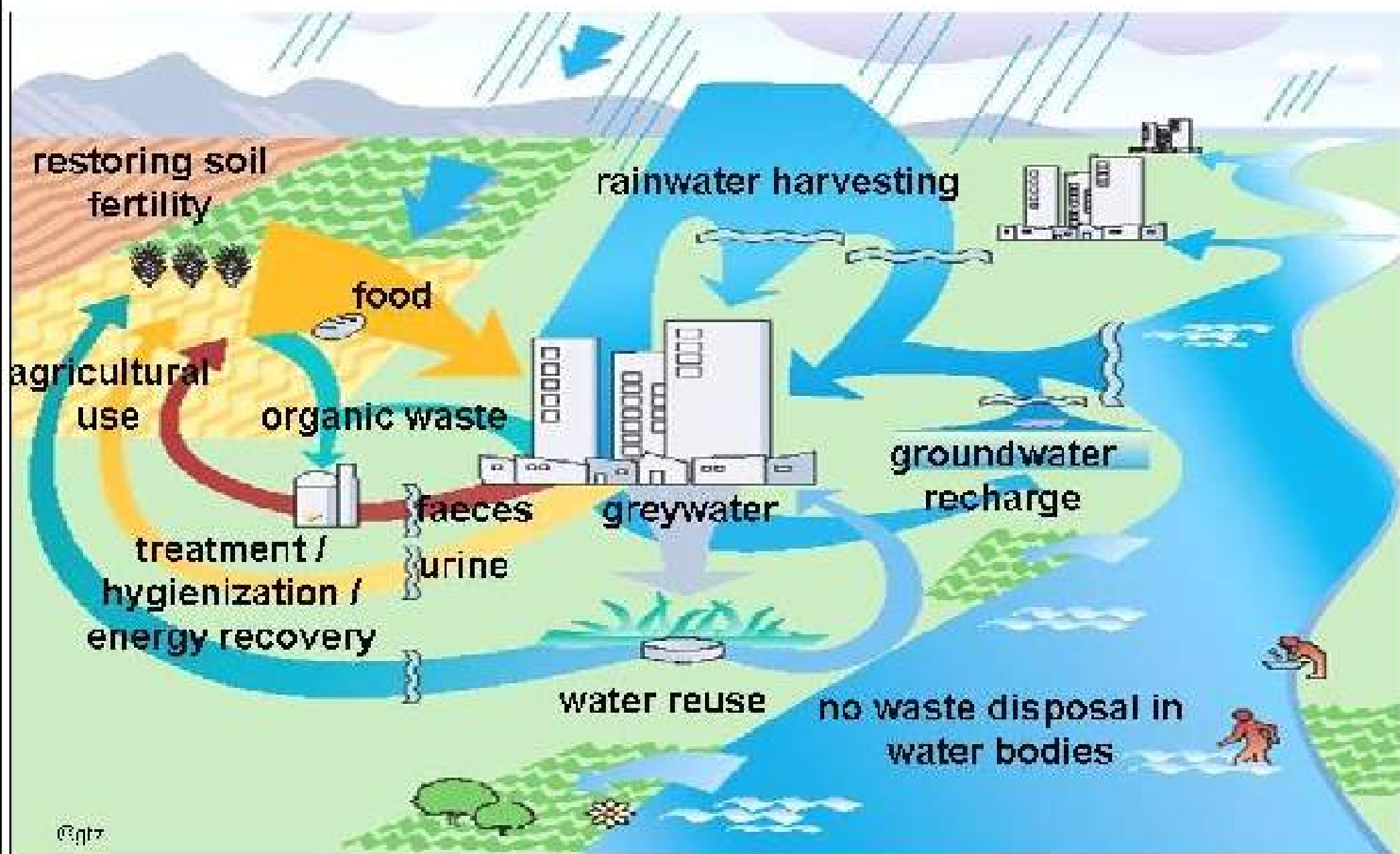
Donaldson



Combined to offer Filtration, Water, and Disinfection Technologies



Ecosan Philosophy



Sanitation

Technologies & Capabilities

- Membrane technology for water purification
- Bio-gas reactors
- Wastewater Treatment
 - Aeration
- Design & implementation services

Minnesota Companies

- Aeration Industries
- Pentair
- Applied Membrane Technology
- HDR Engineering



UofM Collaboration Center

“Connecting the Universities technology to opportunities in India and the developing world.”

Problems and Opportunities



Connect Opportunities to Research



Create Joint Business Opportunities

Office for **Technology Commercialization**



Solutions for India...

Are not imported western products!!

- 3M's approach to "localization" of products

And

- Systems approach solutions

Not just the airport; but the roads to support the airport.

Recommendations

- **1st priority – Sanitation (Waste disposal, Water Purification)**
 - Represent the true need
 - Represent the health impact of not having adequate sanitation
 - Make it in the interest of private industry
- **2nd priority**
 - Transportation infrastructure
 - Infrastructure expansion
 - Maintenance incentive
- **All other priorities**
 - System approach to problem solving (not just the airport, but the road to the airport)
 - Irrigation & Agriculture automation
 - Technology to rid system of middlemen
 - Cold chain to fix food spoilage issue (Unacceptable loss of 40% harvest)
 - Low environmental impact power generation

Moves – Short Term

- **Public Education Campaign - Government**
 - Identification of costs of substandard sanitation (PSA – Give A Hoot!)
 - Make it everyone's priority
- **Low Cost, Immediate Waste Infrastructure Actions – PPP**
 - Centralized waste and recycling centers (transfer stations)
 - Expansion of ecosan concepts (waste bins, composting latrines)
 - Enforcement of the new behavioral norms
- **Incentives to Bigger Business – Government/Private Industry**
 - Make it attractive to take on big infrastructure development
 - Tax credits for socially responsible actions
 - Business consortia to fund beneficial investments (identification of the costs of lacking infrastructure; health, time, loss of opportunity)
- **Engage The Individual - Government**
 - Garbage collection incentive
 - Recycling incentive
 - Urbanized work guarantees

Moves – Long Term

- **Large Waste & Sanitation Infrastructures – PPP**
 - Creation of; or coordination with empowered planning authority
 - Landfill, incineration, bio-reprocessing of waste infrastructure
 - Waste water treatment infrastructure
 - Coupled incentives for socially responsible actions
- **Urban Congestion Solutions – PPP**
 - Similar concept to what London is implementing (Mumbai)
 - Required metering solutions (GPS, RFID) in new cars, motorcycles, other
- **Consumption Based Revenue Generation – PPP**
 - Consolidation of existing toll road structures
 - Increased toll road penetration
 - Other models to support long term development and maintenance

Minnesota Suggestions

- Filtration technology for water purity (3M, Donaldson Company)
- University of Minnesota Civil Engineering Dept.
- Osmonic Water Treatment Plant (GE)
- Minneapolis Waste Incineration Plant
- Cold Chain Technology (Thermo King)
- Video Surveillance/Monitoring (Honeywell, Seagate)



India / Minnesota SWOT

	India	Minnesota
Strengths	<ul style="list-style-type: none"> ● Lots of infrastructure opportunities ● Increasing federal revenues ● Some acknowledgement of issue ● Over \$500 B programmed 	<ul style="list-style-type: none"> ● Educational background ● Large, profit-driven MNC ● Well defined financial markets
Weaknesses	<ul style="list-style-type: none"> ● Bottom 2/3 of country's needs not being recognized (not profitable) ● Bureaucracy , great change inertia 	<ul style="list-style-type: none"> ● True understanding of FDI limitations ● True operational business environment
Opportunities	<ul style="list-style-type: none"> ● Tremendous opportunities ● High Foreign Direct Investment (FDI) can help develop new businesses 	<ul style="list-style-type: none"> ● Partner with local high school to encourage and provide roadmap to University IT programs ● Align and partner with other universities (IIT And IISc) to promote global growth of technologies
Threats	<ul style="list-style-type: none"> ● 2/3 of country hold tremendous power to oppose change (poor) 	

Short-term Moves

Recommendation	Who	What and When	How	Cost
Education campaign	Gov	Identification of costs of not changing current behaviors	Marketing/ Advertising	
Make it in private industries interest to drive infrastructure	Gov	Implementation of tax relief/credits for social infrastructure development	Incentives	
Establish individual-level incentives for participation in public health concerns	Gov	Recycling incentive,	Payment structure development, urban work guarantee	
Simple, low-cost waste fixes	Private/public partnership	Waste bins, Composting toilet systems	Tactical distribution of systems in urban environments	

Long-term Moves

Recommendation	Who	What and When	How	Cost
Transition to consumption based funding mechanisms	Infrastructure owners	Single toll road system		
Long term waste solutions	Public Private Partnership	Landfill development; Incineration methods, Biological reprocessing; recycling		
Urban toll system to relieve congestions	Public Private Partnership	RF ID, GPS, other technology based congestion charging project		

Questions/Remaining

- What other information and concepts are available under the ecosan umbrella?
- Agriculture concerns
 - Why don't 70% of farmers have irrigation
 - Is it a technology problem
 - Is it a water problem
- Why is FDI not rushing into opportunities?
- Why does political stalemate persist (real progress is rewarded with loss of election)?
- Why has the industrial revolution stalled?
- Why is India not learning from US, China (other)?

Technology Transfer in the Rural Sector



Overview

1. Rural Sector and Agriculture in India

- a. History and insights
- b. The Indian agricultural industry today
- c. Comparison with the U.S.

2. Major Players

- a. Government support (e.g. National Agriculture Policy)
- b. Foreign investments & global market

3. Enablers, Barriers to ToT in Rural Sector

- a. SWOT analysis: *1) Indian Perspective 2) Minnesota Perspective*

4. ToT Scenarios

- a. Change in raw material (e.g. UoM gene plasma)
- b. Change in farming process (e.g. Cargill contract farming)

5. IMTP – Lessons Learned and Recommended Moves

Contract Farming Ventures in India

The government of India's **National Agriculture Policy** envisages that “Private sector participation will be promoted through contract farming and land leasing arrangements to allow accelerated technology transfer, capital inflow and assured market for crop production, especially of oilseeds, cotton and horticultural crops.”

Rural Sector and Agriculture in India



Agriculture in India – Background

1. Approximately 22% of GDP but 65% of population in this area
2. Lack of GDP growth in Agriculture – only about 2% currently – World average is 8-9% annually
3. Indian farmers receive less than 1/5 of the price that consumer pays, compared to over a 1/3 in countries like Thailand and USA
4. Production costs are less than half of those in other parts of the world, but high cost of distribution erodes any advantage to Indian farmers.
5. R&D expenditure is third on the list for India – Indian Council of Agriculture funding is about 13.5% of India R&D money
6. National Agriculture Labs: Crop Science (10), Animal Science (7), Horticulture (9)
7. Poor logistics lead to delays and wastage and weaken farmers' incentives to improve quality and yields
8. Limited standardization of farming practices



International Comparisons of Yield

**Table 8. 4 : International comparisons of yield
Selected commodities–2004-05**

<i>Metric tonnes/hectare</i>					
Rice/paddy		Wheat		Maize	
Egypt	9.8	China	4.25	U.S.A	9.15
India	2.9	France	7.58	France	7.56
Japan	6.42	India	2.71	India	1.18
Myanmar	2.43	Iran	2.06	Germany	6.69
Korea	6.73	Pakistan	2.37	Philippines	2.1
Thailand	2.63	U.K	7.77	China	4.9
U.S.A	7.83	Australia	1.64		
World	3.96	World	2.87	World	3.38
Cotton		Major Oilseeds			
China	11.10	Argentina	2.51		
U.S.A	9.58	Brazil	2.48		
Uzbekistan	7.98	China	2.05		
India	4.64	India	0.86		
Brazil	10.96	Germany	4.07		
Pakistan	7.60	U.S.A	2.61		
		Nigeria	1.04		
World	7.33	World	1.86		

Source : Ministry of Agriculture and Cooperation.

Rural Sector and Agriculture in India

1. Colonialism background

- a. British business model
- b. Stigma of Imperialism

2. Gov't and social farming

- a. Government rules limit farm sizes
- b. Physical segmentation of farms only on paper

3. Landlords and farmers

- a. Nearly one-third of all farmers own no land
- b. More than half of all farms are less than three acres
- c. Affluent land owners politically control poorly educated farmers

4. State and local Gov't

- a. Local parties benefit from rural segmentation
- b. Local parties would lose leverage on farmers if consolidation and social farming happened



Technology Transfer: Indian Perspective

S	W
<p>Agriculture represents 20% of GDP 65% agrarian population Population is engaged in policy making Farming land availability Favorable climate Democratic Government Agriculture beyond subsistence</p>	<p>Deficient infrastructure Water quality Old technologies Rural technology delivery Weak Government policies No Government subsidiaries Local corruption Education</p>
O	T
<p>Successful at TT Agriculture reform Farming process modernization Business opportunities (e.g. edible vaccine) Improved yields, reduced waste Higher farm income Improved animal nutrition Globalization, Int'l market Improvement in Infrastructure – including electricity, rail, roads and ports</p>	<p>Widening gap between high-tech and rural technology delivery Substantial poverty in rural sector weaken Government Foreign investments going to China</p>

Technology Transfer: Minnesota Perspective

S	W
<p>High-tech approach to agriculture Large scale enterprise Foreign direct investments Vertically integrated supply chain Robust innovator in farming process and processing capabilities Global market</p>	<p>Dependent on local infrastructure Indian bureaucracy & policies No central point of contact Offset requirements TT more welcome from academia Cargill's bad past experience with Indian market</p>
O	T
<p>Global market Contract farming Retail commodity market Strengthen link between UoM and IIT Governor Pawlenty looking at business opportunities in India</p>	<p>Successful model in another country might not suit India Unable to convince federal and/or local Gov't Push-back from rural population Activists: "Cargill in the name of contract farming is exploiting Indian farmers" IP not protected (e.g. engineered seeds sold to competition) Patenting of life forms (e.g. GMOs) rejected in the market place Fragmented sales for national-level player</p>

Lessons Learned

1. Why Cargill's business model did not fit in India!

- a. There were no tangible benefits to the community
- b. There was no equitable win-win solution
- c. The cultural dimension was more important than the business model
- d. Business model did not include technology transfer

2. The value creation should be obvious to customers

- a. Local vs. national-level player (use local players to develop trust)
- b. McDonald's adage "think global, act local"
- c. Rural farmers should receive financial benefits
- d. Educational opportunity

3. Overcome barriers to direct foreign investments

- a. "Politically correct" strategy
- b. Join ventures with Indian companies
- c. Partnership with academia (e.g. PepsiCo's partnership with Punjab Agricultural University)

Recommended Moves

India

1. Reduce trade barriers, foreign exchange, restriction and strive for economic reform – red tape will be difficult to overcome in short-term
2. Improve communication, transport, storage, distribution and agricultural support services
3. Improve the fragmented supply chain – currently India's transportation costs are on average 20-30% higher than other countries
4. Improve product quality standards and production standards
5. Reduce gap of organized versus unorganized employment
 1. Through educational improvements
 2. Continue infrastructure improvements
6. Create an integrated and competitive domestic market



Recommended Moves

Cargill

1. Investment in educational programs for rural communities – i.e. satellite educational systems / web-based e-learning systems
2. Promote value-added benefits to farmers and cooperatives
 - a. Grain Storage and Grain Handling – Cargill roots
 - b. Improved quality, crop yields and application benefits
 - c. Improved Animal nutrition – Cargill Feeds
 - d. Risk management and farming consultancy – education of new farming practices

Recommended Moves – continued

Cargill

1. Promote benefits to Government for new product development and process development in Agri/Food Sectors
 - a. New Patent Law since 2005 allowing for Food and Agriculture processes and products
2. Innovate in processes rather than products
3. Create more demand by using joint ventures with domestic companies
 - a. Build or lease value-added processing plant such as oilseed plant or bio-fuel plant – will create excess supply of non-food applications
 - b. Leverage strength in Sugar Industry and improved processing techniques for sugar mill – currently opportunity for many plants to improve on energy efficiencies

Recommended Moves – continued

University of Minnesota

1. Promote Technology Transfer for new product development and process development in Agri/Food Sectors
2. Joint effort with Indian Universities for Agricultural Extension Centers – enables farmers to be educated on latest farming techniques and practices
3. Collaborate on Agri-Business Majors and advanced degrees
4. Commercialization of Honey Crisp Apples and other successful UofM Agri-products
5. Collaborate on Animal Science and Nutrition



Medical Industry

Opportunities for India-Minnesota Collaborations



Overview

- Personal experience
- SWOT Analysis
- India Strengths / Barriers
- Business requirements for India
- Opportunities Assessment
- Minnesota opportunities
- Minnesota and India Medical Industries
- Market Access / Partnerships
- Minnesota Actions



Executive Summary

1. Several potential new markets for Minnesota medical device companies
2. Numerous opportunities for industrial and academic collaborations (e.g. device – drug combination).
3. Second source for skilled manufacturing labor for specific medical products (e.g. vascular products).
4. Biggest barriers to enter will be cost, access, and regulatory approval.



India Healthcare: Personal Experience



- Fast – Inexpensive – Efficient
- Self Managed
- Readily available
- Distributed

SWOT Analysis

	India	Minnesota
Strengths	<ul style="list-style-type: none"> ● Cost competitive advantage ● Highly educated workforce ● High savings rate offset need for insurance ● Manufacturing capabilities – labor intensive assembly ● Mobile workforce enables innovation ● English speaking, call-center capabilities, collaborative development experience 	<ul style="list-style-type: none"> ● Strong medical device company base: Medtronic, St. Jude, Boston Scientific ● Global regulatory expertise ● Laboratory testing – Beckman Coulter
Weakness	<ul style="list-style-type: none"> ● Cost pressures ● Job competition with IT sector ● Intellectual property laws ● Lack of strong infrastructure 	<ul style="list-style-type: none"> ● High labor costs ● High development costs
Opportunities	<ul style="list-style-type: none"> ● Partnership with Minnesota universities ● High Foreign Direct Investment (FDI) can help develop new businesses ● Medical tourism ● Acquisition of Minnesota start-ups 	<ul style="list-style-type: none"> ● Partnership with Indian universities ● Partner with Indian medical device companies ● New health delivery business models
Threats	<ul style="list-style-type: none"> ● Rising labor rate ● China 	<ul style="list-style-type: none"> ● Global competition ● Restrictive FDA rules for new treatments ● Profit pressures for large companies ● Loss of IP

India Strengths

- Manufacturing basis
- Skilled labor (knowledge workers and manufacturing)
- Bio and pharmaceutical startups
- Cost competitive



India Barriers

- FDI
- Bureaucracy
- Supply chain
- Business methods
- Policy and legal issues
- Access and exposure

India has significantly fewer doctors and nurses than the world average:

World average 1.2 doctors and 2.6 nurses per 1,000 people

India has 0.6 doctors and 0.08 nurses per 1,000 people

Requirements for Success in India

- Local management
- Cost conscious products
- High volume
- Short-process loops
- Low-tech solutions (e.g. Aravind eyecare, Jaipur foot)

Opportunities Assessment

- The World Health Organization (WHO) estimates 60M Indians suffer cardiac heart disorders, and this is likely to reach 100M by 2011.
- 2M Indians die of sudden cardiac arrest (SCA) every year.
- Only 1% of the population of India has access to US type therapies that use advanced medical devices like pacemakers.

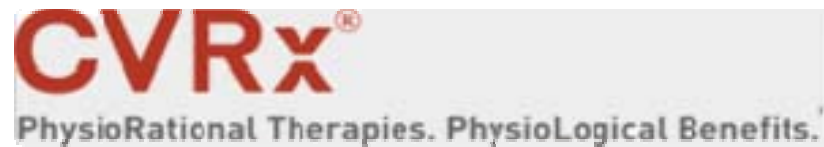


Minnesota Opportunities

- New markets for medical devices
- Device – drug collaborations
- Second source for skilled manufacturing labor (e.g., vascular products)
- University & research collaborations
- Clinical studies and study centers
- Western Medicine meets traditional Ayurvedic (holistic) medicine



Minnesota Medical Industry



Indian Medical Industry



RANBAXY



India Market Access

- Central Drugs Standard Control Organization (CDSCO) and Indian Ministry of Health
 - Provides guidelines for import, registration, manufacture, and sales of medical devices (latest revision June 2005)

India Medical Device Partners

- Shree Pacetronix
 - Seventh largest manufacturer of pacemakers in the world and has 35% market share in India.
 - Aim to launch a defibrillator for ~\$5000 USD.
- Medived
 - In collaboration with CCC Medical Devices (Uruguay)
 - Brand new, world-class manufacturing facility in Bangalore India for advanced implantable medical devices,



Ventralith-I :
VVI Non Programmable Pacemaker



Pinnacle:
VVI, multi-programmable pacemaker



Charak:
DDD, multi-programmable pacemaker



Stellar:
VVI, multi-programmable pacemaker

Potential India State Partners

- Pharmaceuticals:
 - Dr. Reddy's: Andhra Pradesh
 - Jubilant: Uttar Pradesh
 - Ranbaxy: Haryana
- Medical devices
 - Shree Pacetronix: Madhya Pradesh
 - Medived: Karnataka

Minnesota Actions

Company	Leading	Opportunity
Medtronic	Medical devices, heart valves, spinal products	<ul style="list-style-type: none"> • Create partnerships and utilize India's strength in skilled labor and manufacturing for surgical and vascular products. • Create clinical study partnerships • Evaluate long-term implantable device opportunities (Shree Pacetronix) • Drug collaboration for devices
Upsher-Smith	Generic pharmaceuticals	<ul style="list-style-type: none"> • Form partnership to leverage generics distribution and regulatory knowledge
AGA Medical	Heart repair products	<ul style="list-style-type: none"> • Create partnership to sell heart repair products
Incisive Surgical	Sutures	<ul style="list-style-type: none"> • Establish relationship to bring Insorb® surgical sutures to market

Biotech Market – Dynamic and Growing

ØMarket size (2004-05)

US \$1.9B

ØLargest segment

Biopharma

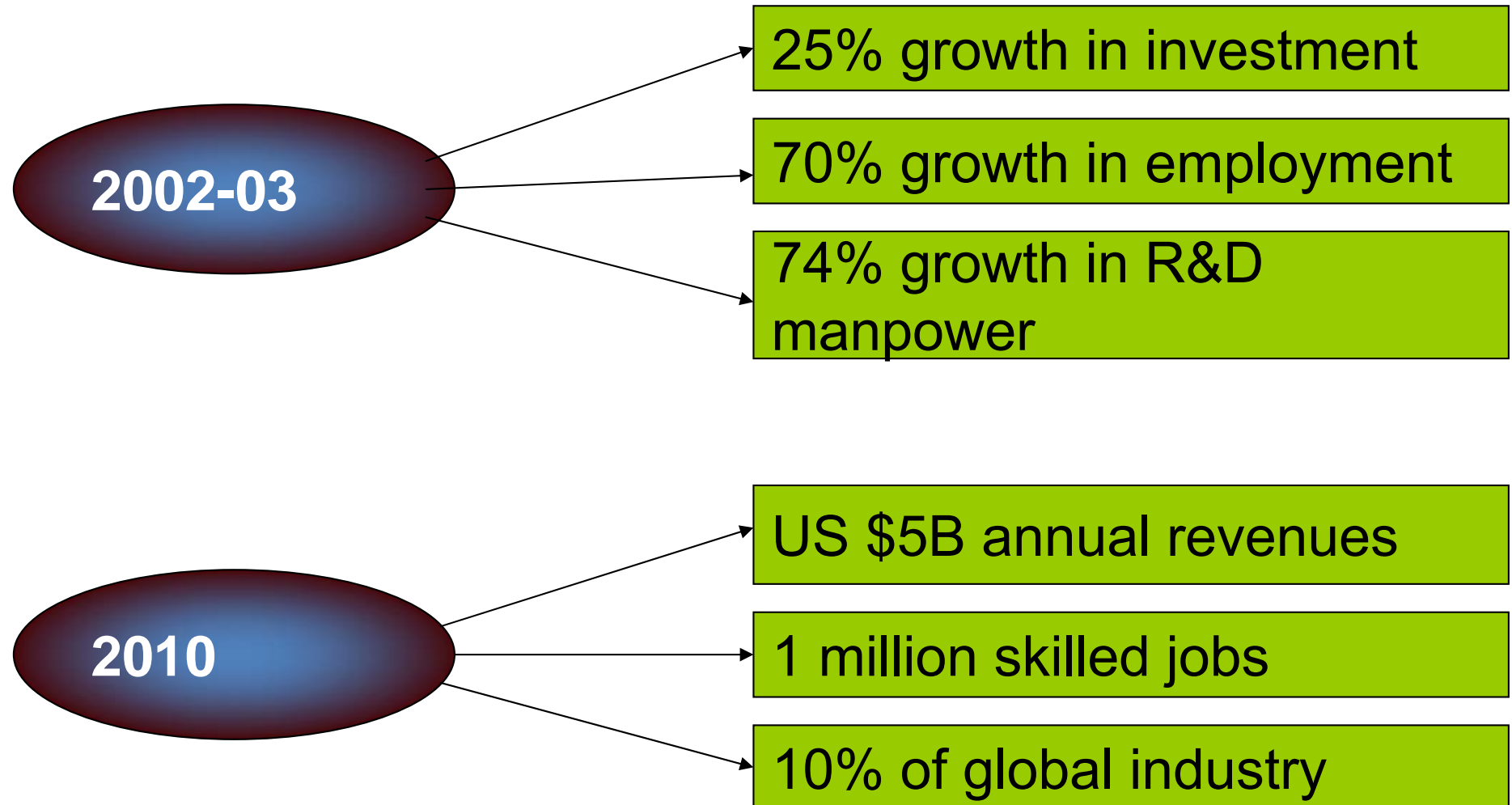
ØRevenue from exports 2003-04

56%

ØTotal investment 2003-04
Growth rate over 2002-03

US \$137M
26%

Biotech Market – Consistent Uptrend



Source: Confederation of Indian Industry (CII)

Diagnostics Segment Factors

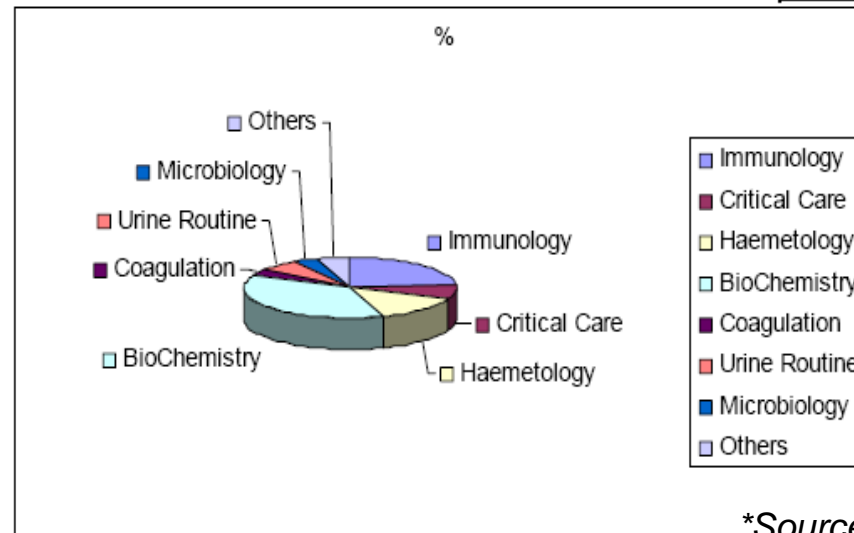
- Healthcare represents 5.1% of GDP
- Population to grow from 1 to 1.6 billion by 2012
 - 14% covered by healthcare (prepayments)
 - 64% pay out-of-pocket
- 30,000 labs serving 1-1.25 million patients/day
- 25% annual growth

Diagnostic Segment Areas of Focus

- In-Vitro Diagnostics (IVD)
 - Rs. 6.75 billion
 - US \$147M
 - 40% equipment
 - 60% re-agents

Segment	%
Immunology	24%
Critical Care	7%
Haemetology	14%
BioChemistry	37%
Coagulation	3%
Urine Routine	6%
Microbiology	4%
Others	5%

IVD Market in India*



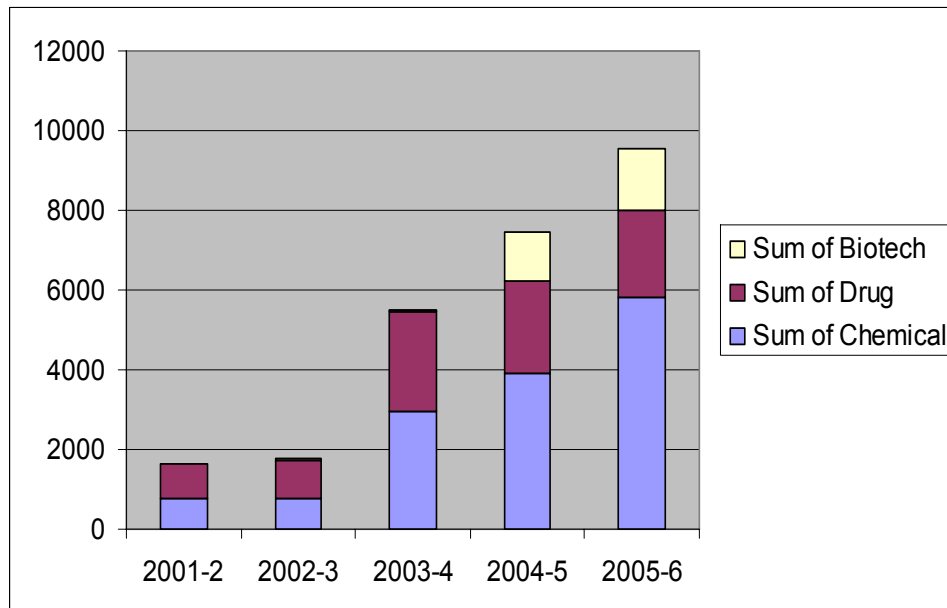
*Source: Suresh Vazirani
Transasia Biomedicals, LTD

Diagnostic Segment Issues (technology)

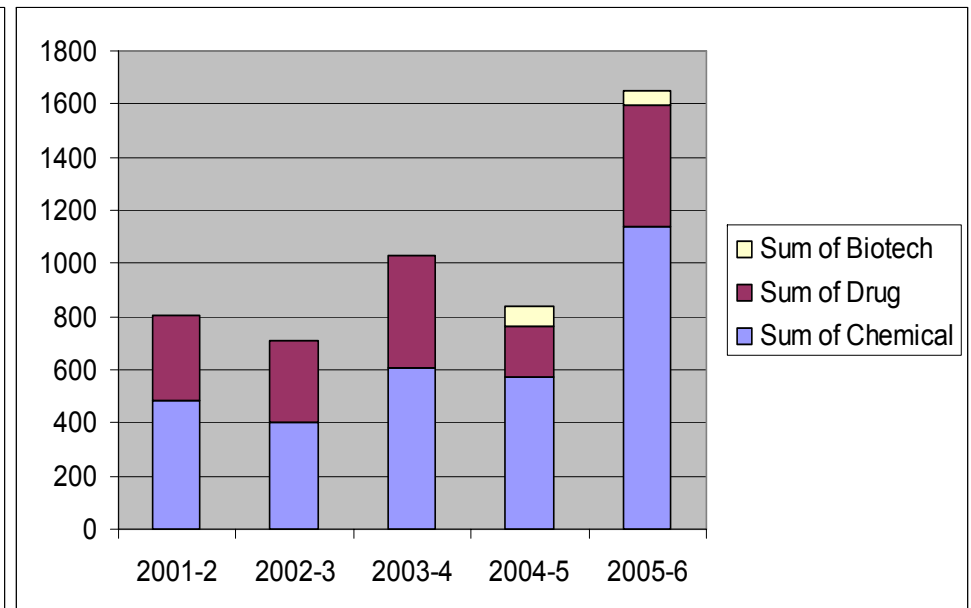
- Intellectual property
 - Enforcement is difficult; litigation is slow
 - Before 2005, 90% biotech products were un-patentable
 - Patent application alone obtains 5 1/2 years of protection and serves to block competition
 - Less than 5% of patent applications are actually granted
 - Insufficient resource has been a process bottleneck
- Development capabilities
 - Preference for products over technologies

Patents

Applications



Approvals



The Indian patent regime is changing ...

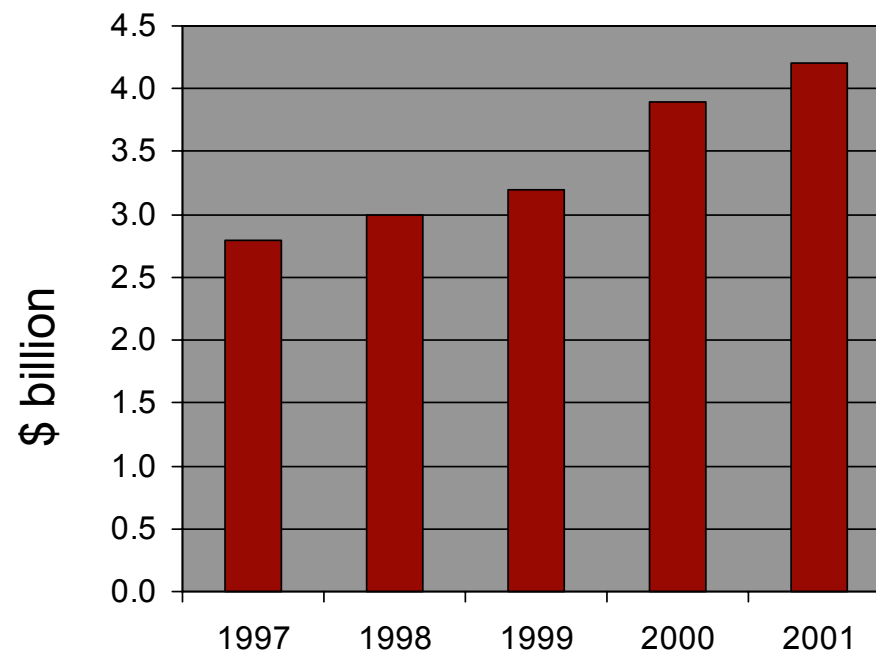
- Compliance with the TRIPs agreement .
- Drugs will become patentable as products, and not just as processes.

Diagnostic Segment Issues (social)

- Diverse population
 - Reaching beyond major urban areas to rural needs
 - No “average” Indian consumer – segment the market
 - Lack of prepaid healthcare will require direct to consumer marketing and distribution
 - Per capita income is very low and product offerings must be priced accordingly
- Social implications
 - Anyone licensing patents to India must consider the social implications (e.g. GE Ultrasounds)

India on the Biotech Radar

- India's share in the global biotech market is currently about 2%.
- Sales of biotech products in India are growing at a CAGR of 8.4%.



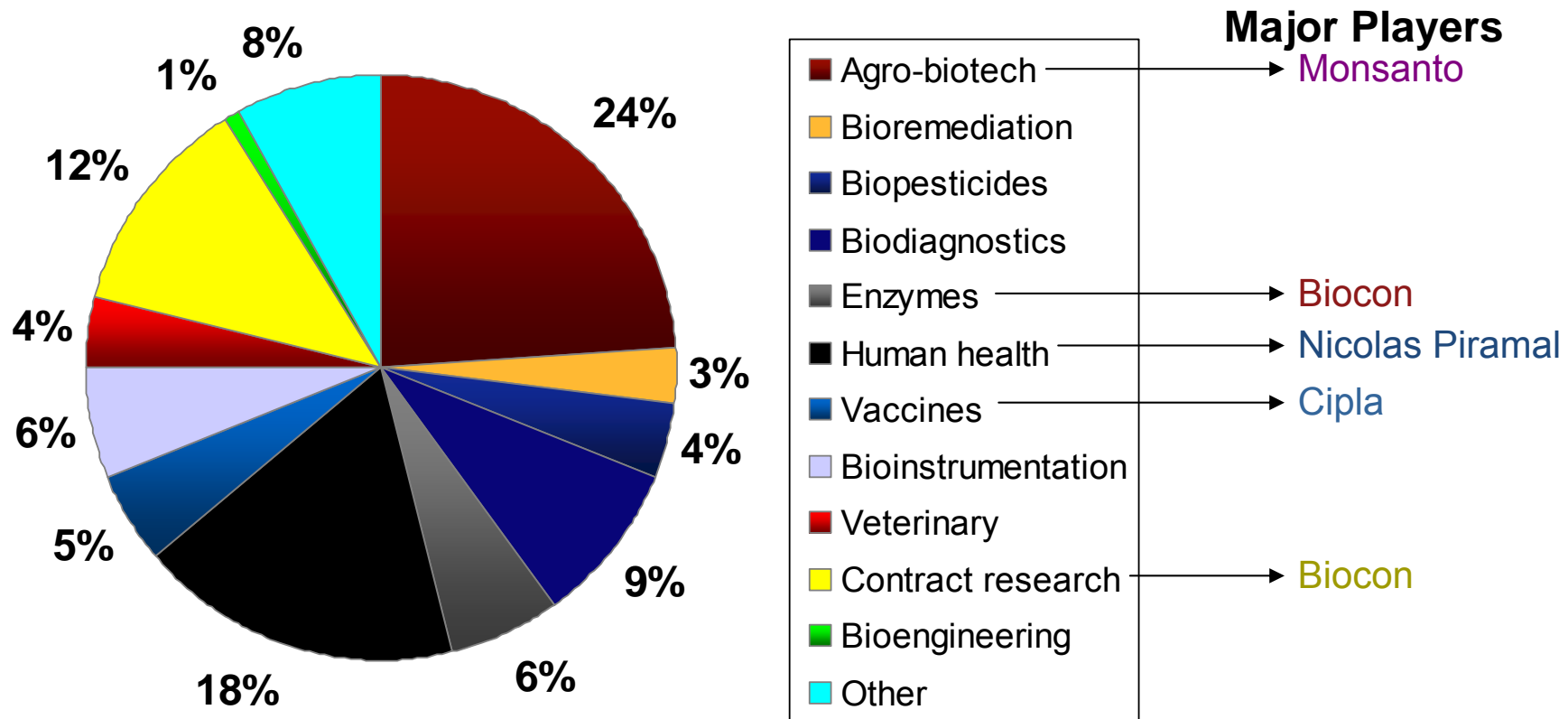
*Source: A Report on the
Indian Biotechnology Market
Mindbranch.com*

Domestic Companies - Going International



SERUM INSTITUTE OF INDIA LTD.

Distribution of Indian Biotech Companies



Total number of companies = 175

Source: *Biotech India 2003*

Agro-biotech (including seeds) is the largest sector with 42 companies

Example R&D Expenditures

COMPANY	R&D/REVENUE (%)	LINE OF RESEARCH
Workhardt	10.5	Genome technology
Zydus Cadila	7.5	Genome technology
Torrent Pharma	6.4	Pharmaceuticals
Ranbaxy	6.0	Pharmaceuticals
Biocon	5.0	Enzymes
Dr. Reddy's Labs	4.4	Therapeutic proteins
Cipla	4.0	Vaccines
Sun Pharma	4.0	Pharmaceuticals
Average	5.9	

Sources: A Report on the Indian Biotechnology Market
Mindbranch.com & Biotech India 2003

Government Support via Research Allocation

AGENCY	BUDGETARY ALLOCATION * (RS. CRORE)
University Grants Commission (UGC)	1,407
Indian Council of Agriculture Research (ICAR)	1,399
Council of Scientific and Industrial Research (CSIR)	912
Department of Science and Technology (DST)	779
Indian Council of Medical Research (ICMR)	147
Department of Biotechnology (DBT)	136
Department of Scientific and Industrial Research (DSIR)	58

Total budgetary allocations

~ Rs. 50 billion

*Source: Status and Development of Biotechnology in India: An Analytical Overview Sachin Chaturvedi
RIS Discussion Paper*

Opportunity Categories

- Technology Transfer (licensing revenue)
- Outsourcing Business Processes (cost savings)
- Leveraging R&D expertise (extending innovation)
- Entering growing Indian Market (global footprint)



Indian Company Observations

- GE
 - Auto bone, Reach-in diagnostic imaging, Surgical navigation
 - Initially unsuccessful; re-focused on people in India until ready to go back to markets
- Phillips
 - Imaging technologies (e.g. MRI)
 - Value chain strategy
- Jubilant Biosys
 - Strengths in reverse engineering
 - Focus on support services business model and drug development (not marketing)

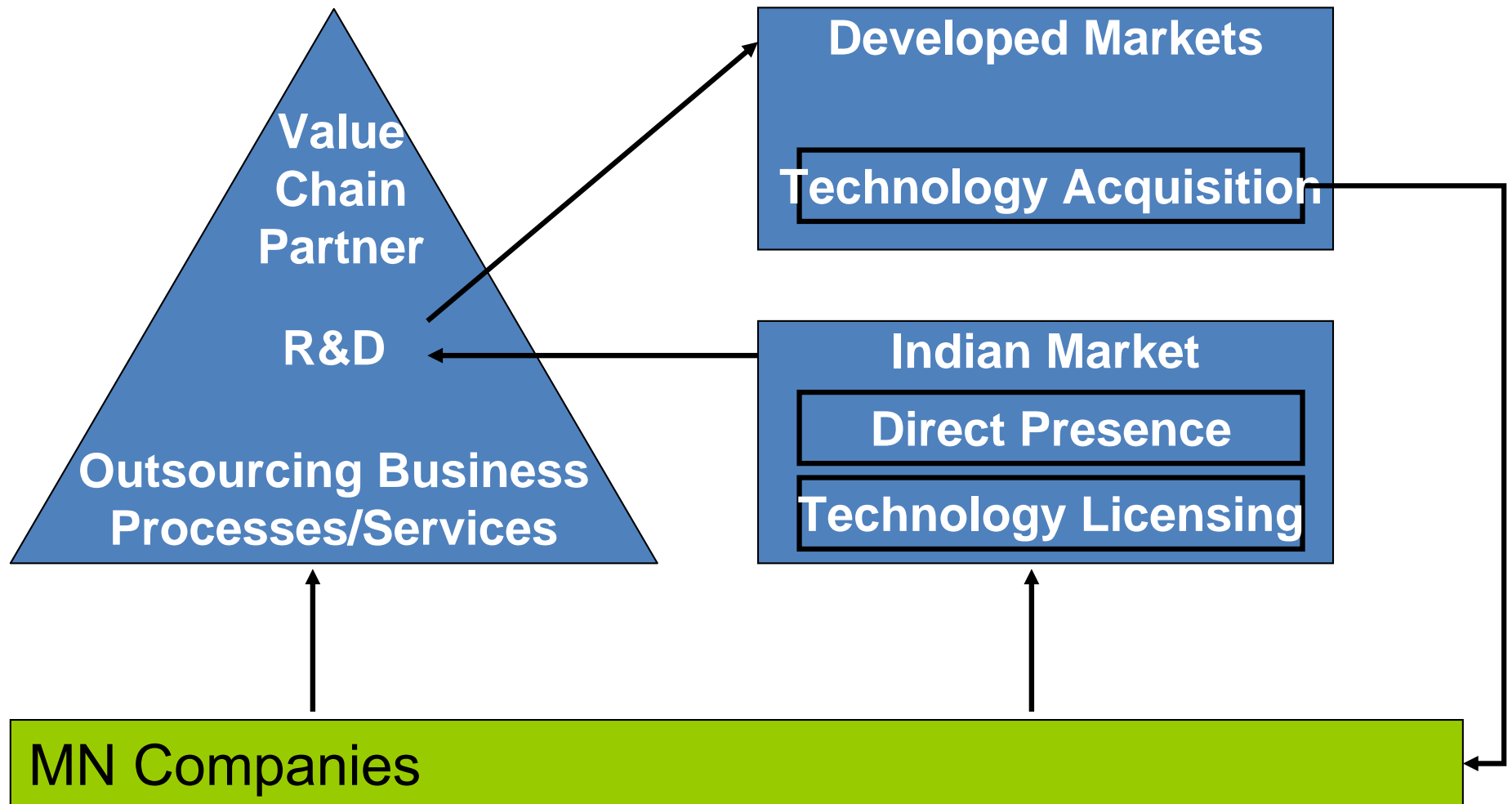
Case Study: GE

- GE Healthcare
 - US \$17B company
 - Entered India in 1970
 - Invested US\$100M in India
 - Sourced 15% of its products in India (2x2002)
- India not viewed as cost arbitrage but for talent pool
- Three diagnostic imaging products to be introduced in 2007
 - Auto bone, Reach-in diagnostic imaging, Surgical navigation
- Collaboration with Manipal Hospitals in Bangalore
 - GE's Global Clinical Studies Program
 - Supports vision of “Early Health” using diagnostic imaging
 - Benefit local patients through increased access

Case Study: Inverness Innovations

- Inverness Innovations
 - US \$552M company
 - Entered India in 2007
 - Acquired two Indian companies (distribution and assembly)
 - \$4M purchase price + bonus if successful after one year
- Collaboration combines innovation and local distribution
 - Spectral Diagnostics Private Limited – distribution
 - Source Diagnostics Private Limited – assembly and packaging
- Rapid professional testing
 - India population needs testing for blood borne pathogens
 - HIV, Hepatitis, Malaria, Dengue Fever, and Tuberculosis

Opportunity Model



Key Questions

- How does the Indian market compare to other developing markets for medical diagnostics (e.g. China, Brazil, others?)
- What are the trends and potential value for IP applications?
- What is the potential for disruptive innovations to spill over to developed markets?



Resources

- **Technology Transfer**
- The Department of Biotechnology
<http://www.dbtindia.gov.in/> - tracks technology transfer in India
- The Asia and Pacific Center for Technology Transfer (APCTT) <http://www.apctt.org/> - facilitates technology transfer and brings buyers and sellers together
- **Networking**
- The American Chamber of Commerce in India (AMCHAM - India) <http://www.amchamindia.com> - can help with understanding business conditions and networking

Resources

- **U.S. Commercial Service: Gold Key Service**

American Center, 24 Kasturba Gandhi Marg

New Delhi 110001- India

Tel: 91-11-23316841, Fax: 91-11-23315172

- Matchmaking appointments with pre-qualified sales representatives and partners, appropriate government officials, related associations and others
- Customized market and industry briefings

- **Directorate General of Health Service**

Ministry of Health

Nirman Bhawan

New Delhi

Phone: 91-11-2-301-8863

- **Confederation of Indian Industry**

Lodi Road

New Delhi

Phone: 91-11-2-462-9994

India's Aerospace and Defense Sector

"A tough environment has driven quality systems"



SWOT – Aerospace and Defense

	India	USA
Strengths	<ul style="list-style-type: none"> • Self reliant • Very strong and autonomous space program • Very strong technically • Solid Commercial Companies 	<ul style="list-style-type: none"> • Self reliant • High Tech • Strong Industrial base that is commercially operated • ~ 85% “Systems Contracting”
Weaknesses	<ul style="list-style-type: none"> • Some reliance on Russian defense systems • Lots of systems (too many calibers) • Most procurements are “breakout” • Defense Industrial Base is Govt.Owned/Govt. Operated (GOGO) 	<ul style="list-style-type: none"> • Unwilling to transfer technology internationally • Most US companies don’t have an effective Global Strategy (“Made in the USA”) • US Embassy does not currently have a mechanism for US Defense contractors to source supplies from India
Opportunities	<ul style="list-style-type: none"> • Move to GOCO (commercial operate) • Export Defense articles and Space services 	<ul style="list-style-type: none"> • Align with India for a NATO- like common operating specification, i.e., common calibers, interchangeable systems, etc.
Threats	<ul style="list-style-type: none"> • China • Red tape (both in India and US) 	<ul style="list-style-type: none"> • China • Red tape (again both ways)

Business Scenario

The United States-India Peaceful Atomic Energy Cooperation Act

Today, President Bush Signed The United States-India Peaceful Atomic Energy Cooperation Act. This Act will strengthen the partnership between the world's two largest democracies and help our countries meet the energy and security challenges of the 21st century.

This Act Is An Important Step That Will Help Allow Us To Share Civilian Nuclear Technology And Bring India's Civilian Nuclear Program Under The Safeguards Of The International Atomic Energy Agency. On his visit to India earlier this year, President Bush reached an historic agreement with Indian Prime Minister Singh, under which the United States and India committed to take a series of steps to make nuclear cooperation a reality. The bill the President signed today is one of the most important of these steps. Nuclear cooperation will help the people of India produce more of their energy from clean, safe civilian nuclear power, help both our economies grow, and make America more secure.

America And India Are United By Deeply Held Values. Our two great democracies are allies in the War on Terror, partners in global trade, and stewards of our environment. India is a democracy that protects the rule of law and is accountable to its people, and an open society that defends freedom of speech and freedom of religion.

The United States And India Are Working Together To Expand Economic Opportunities In Both Our Countries. India's economy has more than doubled in size since 1991, and it is one of the fastest-growing markets for American exports. This trade is creating new jobs in America and raising the standard of living for millions throughout India.

“America will continue to work with India to promote free and fair trade – and fuel economic growth in both countries.”

Business Development for Minnesota Companies

Aerospace:

Company	Opportunities
NWA	Partnership with Indian Carriers Additional MRO facility in India
Mesaba	Purchase SARAS when available Next-Gen Regional Carrier under development by HAL
Goodrich	Commercial Sensors sales and source of supply Already in India - partner with HAL
Lockheed Martin NESS	Commercial Avionics
ATK	Co-development with ISRO on Space systems
Cirrus Design	HANSA and SARAS Licensing Partnership with HAL
3M	Filters, materials, etc. Global R&D Facility in India

Aerospace Example – Cirrus Design

• Scenario:

- Cirrus wants to expand into US DOD marketplace with a light trainer for Air Force Preliminary Flight Training
- Cirrus is currently developing their own jet but they also want to expand its product line for Corporate and Regional Carriers – they need a twin engine commercial d

• Moves:

- Cirrus partners with HAL in India to offer the following:
 - SARAS Multi-role Light Transport
 - HANSA-3 Composite Light Trainer
- Cirrus has sales and distribution in the USA
- Gives Cirrus an immediate Product line extension

• Tech Transfer both ways:

- Co-production in the USA
 - HAL sends kits for final assembly in US
- Cirrus integrates their unique Parachute Recovery System into HANSA to for product improvement. This better positions the system to win the Air Force Contract. Previous system (Firefly) had multiple CLASS A Mishaps which led to permanent grounding of the system

SARAS – NAL's Multirole Light Transport Aircraft



HANSA –3
(NAL's All – Composite Light Trainer Aircraft)



Business Development for Minnesota Companies

Defense:

Company	Opportunities
ATK	Buy ammunition Co-develop Space systems
BAE Systems	Sell cannons Subcomponent Source of Supply
Goodrich	Sell sensors Co-develop with Indian Govt. Labs
Lockheed Martin NESS	Subsystems for 3 major LMT pursuits
Honeywell	Already a large presence in India Export version of JDAM
General Dynamics	“Spider and Matrix” in Kashmir Co-production in India
Polaris Industries	ATV sales to India Subcomponent Source of Supply
U of MN	“Throwbot” collaboration

Defense Example – ATK Civil Ammunition

- **Scenario:**

- ATK would like to expand capacity to account for their new Global Strategy
- They need capacity off-shore for good quality small arms ammunition
- ATK Civil's R&D staff is at max-capacity – finding ammunition Design Engineers is difficult

- **Moves:**

- ATK buys ammunition from the Indian Ordnance Factories
- Imports some to US to help support commercial demand for .223 Rifle
- Uses majority of ammunition to open markets in Europe and Far-East
- ATK forms Memorandum of Understanding (MOU) with India Defense Research and Development Organization (DRDO) for ammunition design (Direct Foreign Investment)
- ATK gains off-set credits for fulfillment of other opportunities in India or trade with other US Defense Contractors that have incurred an offset obligation

- **Tech Transfer both ways:**

- ATK gains capacity and could transfer technology to improve the Indian Factory capacity
- ATK would structure MOU with DRDO so that the designs we co-develop could be used for the Indian MOD (Govt. Purpose Rights – no export)

Maintenance, Repair, and Overhaul (MRO) Market

	India	Asia
Year	Estimated market	Estimated market
2004	\$615 million	\$8100 million
2010	\$1174 million	\$12179 million
2020	\$2606 million	
Annual growth rate	10%	6.9%

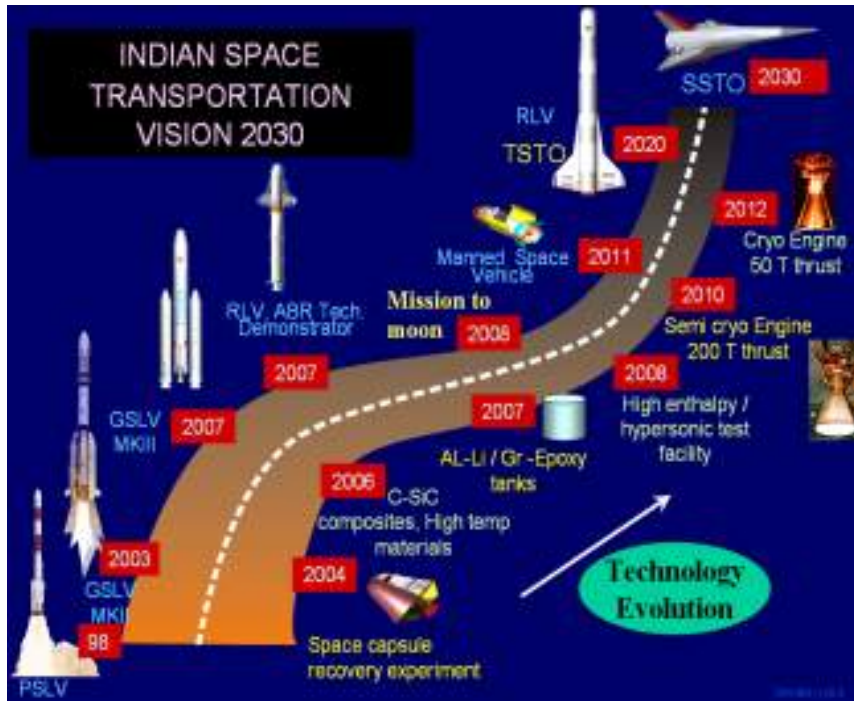
Source : Report on MRO / AeSI, May 06

Joint Ventures – A Key to Success

- Joint ventures / partnerships between key MRO players across OEM, third parties, etc.
- Provide an optimal route to fulfilling key factors with respect to:
 - Extending service portfolio
 - Broadening global logistics
 - Global management infrastructures
 - Leveraging existing marketing asset pool, existing customers
 - Leverage an acknowledged strong brand positioning
- ROM Estimate for Establishing Independent MRO Facility in India
 - Air frame MRO: \$60 – 80 M US
 - Engine MRO: \$80 – 100 M US
 - Component MRO: \$15 – 20 M US



Another Observation



DRDO NEWSLETTER
 A Monthly News Bulletin of Defence Research & Development Organisation
 Vol. 37 February 2017 No. 1

NEW PRODUCTS

HOLOGRAPHIC SIGHT FOR RIFLE AND CARBINE

RIDE

Instruments Research & Development Establishment (IRDE), Dehradun, has developed the prototype of *Holographic Sight for Rifle and Carbine* based on OSQR from the Army HQs. This is the first application in India of holography for small arms. The holographic sight has the advantage of shooting with both eyes open along with faster target acquisition (speed) and improved accuracy. It also leaves no signature to be detected by the enemy. The device is very useful for soldiers in Close Quarter Battle (CQB) and Counter-insurgency (CI) operations, where speed is very critical.

Holographic reticle pattern is embedded in the see-through window of this device. Basically it is a transmission hologram that generates the virtual image of reticle on illumination by the laser diode. The shooter looks through this transparent window, which the projected holographic reticle acts as an aim point, superimposed on the target. If this window is partly damaged in the battlefield, the holographic reticle remains intact in the unbroken part and shooter can still engage the target.

The development of indigenous holographic sight involves development of various other technologies like recording and reconstruction of reticle-hologram, fabrication of holographic lens for collimation and temperature compensation, and microcontroller-based power variation of laser diode. All these technologies were successfully developed at IRDE, Dehradun.

In This Issue...

- New Products
- Holographic Sight for Rifle and Carbine
- DRDO Air Defence Target Interception Mission
- DRDP Responsibility handed over to DRDO
- DRDL, Kolkata to PDR
- DRDL launches DRDO 9001/000
- DRDL Development Activities
- DRDL Accreditation by DEA
- DRDL News
- DRDL News
- DRDO Facility kept open to scientific exhibit
- DRDO

Projected Holographic Reticle

Reinventing the Wheel?

Macro Issue of S&T

• India:

- Recommend moving away from use of Russian systems
- Increase collaboration with US/India Joint Ventures
- ISRO collaboration with NASA should run deeper into NASA's supply chain
- Look to co-production and co-development of Aerospace and Defense systems
- Consider "Indirect offsets" (infrastructure?)
- Boeing and Honeywell offer excellent case studies on India

• USA:

- US State Department has stated they are willing to grant more Technical Assistance Agreements (TAA's) and Manufacturing License Agreements (MLA's) in India.
- "Integrating Indian private sector companies into the global supply chain of US defense manufacturers, combined with co-production, will help remove insecurity about the reliability of US defense supplies." (US India CEO Forum)

Useful Resources for Doing Business in India

- <http://mod.nic.in/dpm/welcome.html>
 - India's MOD procurement publications
 - Mandatory reading
- <http://www.tenders.gov.in/>
 - Tenders of all types/all agencies for Govt. of India
- <http://www.drdo.org/stender/index.php>
 - Tenders for DRDO
- <http://www.drdo.org/labs/dls/drde/tech.shtml>
 - List of technologies spun off to commercial sector
- <http://www.drdo.org/labs/dic/index.shtml>
 - International collaboration with DRDO

Sources

- Interviews with multiple State Department and DOD personnel at US Embassy, Dehli
- “US India Strategic Partnership”, US India CEO Forum, March 2006 Report
- Interview with Member of India’s Ordnance Factory Board



IT

Site Visits - Infosys, Wipro, SAP, Google

- Culture of the 4 organizations
- CMM – New level of Maturity
- Commonality observations in these 4 companies
- Captives vs. Outsourcing
- IT Infrastructure

- Question

Why is Google the #1 company to work for in the U.S.?

IT

Site Visits - Infosys, Wipro, SAP, Google

Questions to ask

- Long term sustenance of the outsourcing model
- Labor Shortage – How is it being addressed?
- Attract and retain best employees
- New thinking in staff management
- Measurement and Metrics
- Turn around time for Projects
- What about In sourcing?

Other Sectors

Growth in other sectors

- Technology
- Pharmaceuticals
- Healthcare
- Banking
- Hospitality



Macro Economics

- Buying Power of the middle class
- Trickle down economics
- Real Estate Market
- Exclusive Products
- Life Style



Innovation Centers and R&D in India: Connecting to Minnesota



Project Focus

- This project reviews and analyzes opportunities and challenges inherent in R&D and Innovation Centers in India.
- The project will explore collaborative opportunities for Minnesota companies and educational institutions to grow globally.

Executive Summary

- The R&D Pros for India include access to:
 - deep talent
 - low costs
 - wide ecosystem
 - vast markets
 - English is common language
 - attractive to expatriates



Executive Summary

The R&D Cons for India include:

- Higher Education Issues:
 - Too few Engineering Ph.D.s in India
 - Inadequate incentive structure for the faculty
 - Innovation education gap
- Private Sector Issues:
 - employee attrition
 - rising compensation costs
 - IP
 - Dependence on expatriate talent.
 - Poor Infrastructure
- Government Policy Issues:
 - India's R&D expenditure rate, at 0.8% of GDP, is low.

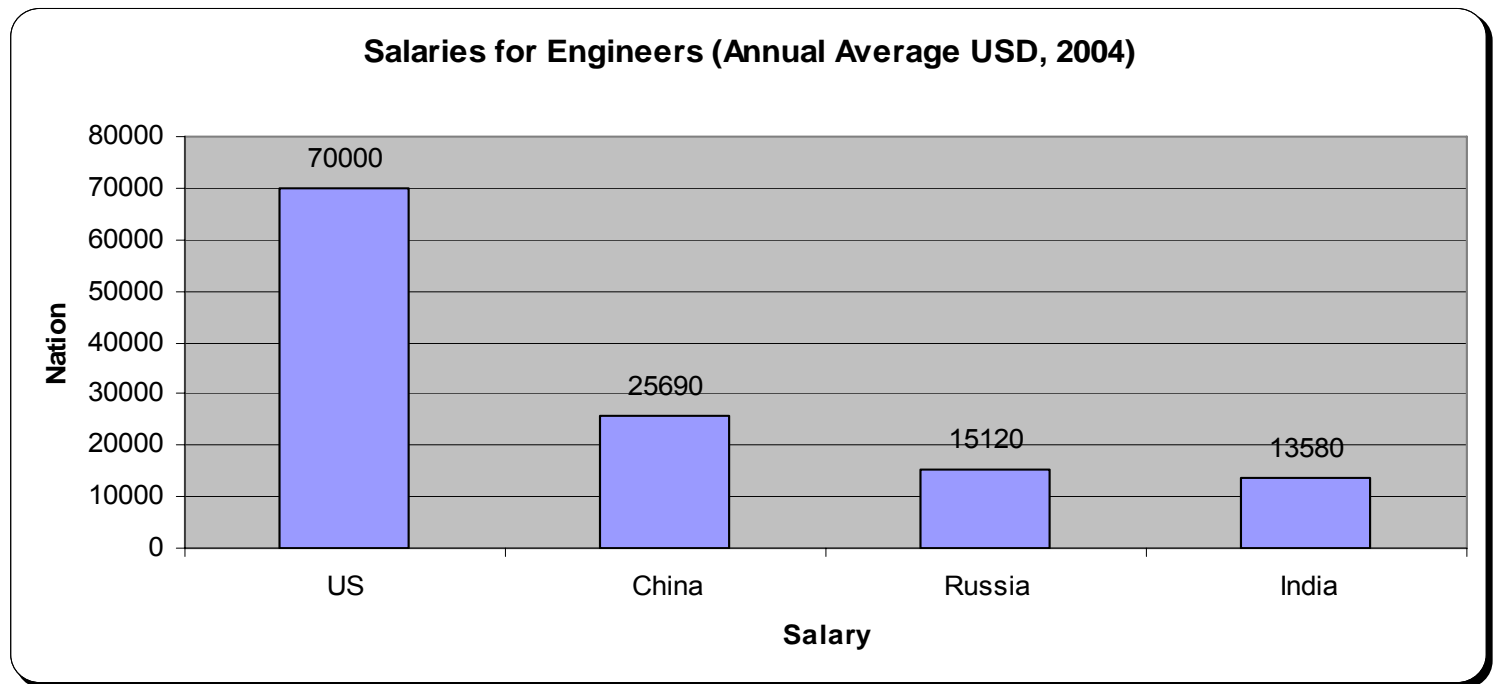
And yet, India is now the preferred destination for new multinational R&D spending.



Why R&D in India? Cost Savings is NOW

- Cost

- R&D cost savings may be in the range 15% - 28%.
 - Salaries, construction costs low.
- However, McKinsey reports that, by 2015, total compensation for U.S. and India research scientists will be roughly equal.



Why R&D in India? Talent

- India has considerable educated, experienced yet young talent.
 - Indian graduates are world-class.
 - Studies show that Indian graduates tend to work longer hours than their German and U.S. peers.
- Availability of Masters level talent is sufficient, but Engineering Ph.D. level talent is scarce.
- English is a required language for higher learning.
- Indian R&D centers are benefiting from the return of the Ph.D. diaspora.
 - Many Ph.D.s *are* returning to India as wages increase, as challenging jobs become available, and as housing and infrastructure improves.

Why R&D in India? Local Market Access

- Local Market Access

- India is one of the world's premier software clusters.
 - India, is a “software development market,” which informs, energizes, and, for its part, *needs* software R&D.
- India is also a vast market in traditional terms benefits from physical proximity.
 - 300 million strong middle class continues to grow. (8 million cell phone users being added every month.)



India Universities: Limited Supply?

- Physical infrastructure
 - 7 IITs, which have about 15,500 undergraduate and 12,000 graduate students.
 - 4 new IITs were recently proposed to remedy the gap. Target completion during this 11th 5-year plan.
 - Estimates show India had about 184,000 engineering grads in 2004, of which about 6,000 were Ph.Ds.
- India does not turn out enough Ph.Ds to meet market demand
 - Demand of Ph.Ds is a new phenomena.
 - The incentive, to students, is far too small to continue to a Ph.D. because good jobs readily await undergraduate Master degree graduates.
 - Output of *Indian* Ph.D. is not meeting today's needs.
- Faculty
 - Professors can do consulting but have to share up to 40% of the fee.
 - Concentrate on teaching; the time devoted to research often lags international standards.

Culture: Creativity Gap?

- Indian disposition toward conformity, lack of individualism and aversion to change in education system.
- Indian disposition toward fear of failure. Most R&D projects fail.
- Limited innovative traditions; only in private sector.
- Organizational and cultural reliance on hierarchy and procedural learning.

Challenges and open questions:

- Can India do truly disruptive R&D?
- Can Indian R&D expand past product development?
- How quickly can culture evolve; what incentives exist?

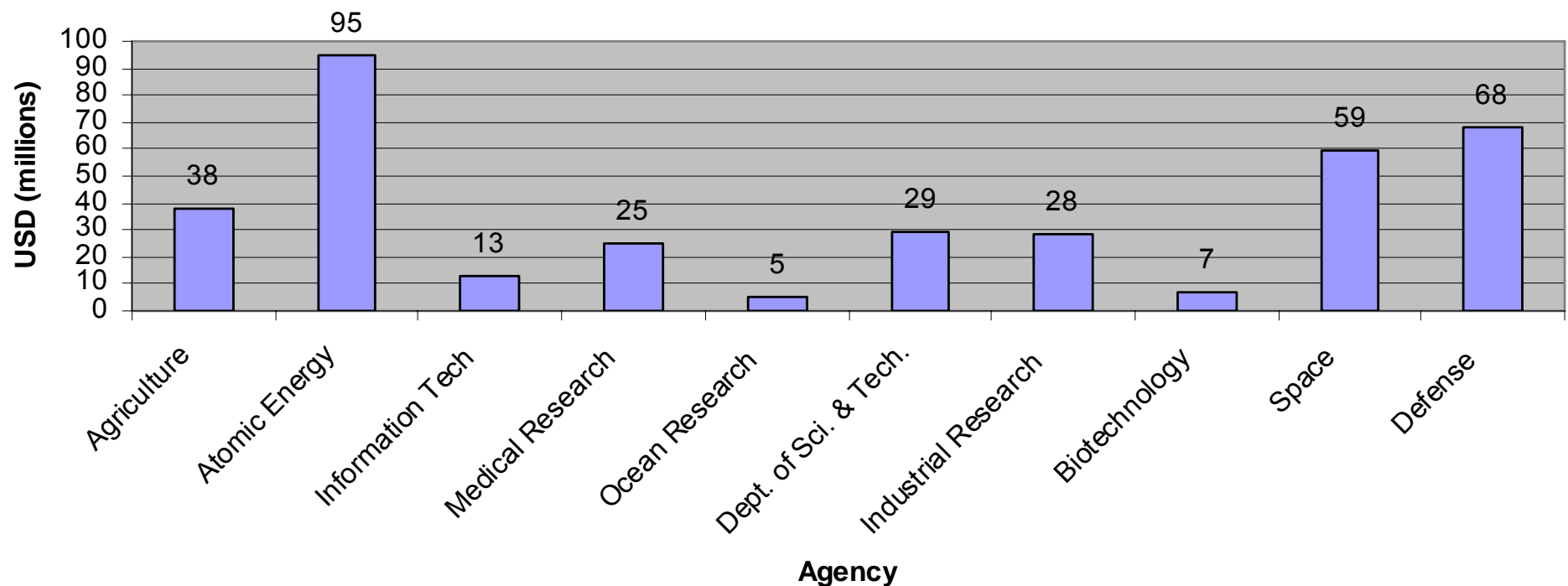
Private Sector R&D Efforts

- “A McKinsey survey of 5,500 senior corporate leaders of large corporations worldwide (each with revenues of at least one billion dollars) revealed that India is the preferred destination for investments in R&D.”
- R&D is conducted in India through:
 - in-house R&D
 - collaboration with other companies
 - contracts
- The private sector has “contributed significantly to a sharp rise in patent filings from India in the 2000s.”
 - India “has adopted the IP regime formulated by the World Trade Organization (WTO) in 2005.”

India Government: Limited Support

- Although India's percentage R&D ranking is low, "spending levels are indeed substantial on a purchasing power parity (PPP) basis." PPP adjusted, India ranks 7th.

Gov. R&D Expenditure by Scientific Agency (2004)



India Government: Limited Support (Continues)

- “The government’s role in S&T has...gradually shifted towards a greater emphasis of commercially oriented R&D and private-public sector partnerships.”

Country	Population (Millions)	Researchers in R&D (people per million)	Expenditure on R&D (% of GDP)	IT Expenditures (% of GDP)	IT Expenditures (per capita USD)
	2004	1996-2002	1996-2002	2004	2004
India	1,080	120	0.85	3.8	24
China	12,926	633	1.23	4.4	66
U.S.	294	4,526	2.66	9.0	3595

Challenges of Innovation and R&D in India

- The attrition rate is high – 15% - 20%.
 - Google, for example, might offer 4x the salary to lure away a Ph.D. because they only need four resources to start with.
 - R&D staffing can be dependent on the technology diaspora.
 - *IBM CEO Samuel J. Palmisano: "The biggest issues for us are: How do you retain them? How do you develop them? How do you move work to them or move them to work?"*
- The "United States Trade Representative (USTR) has retained India in its 'Special 301' watch list of 48 countries on the grounds of inadequate IRP protection."
 - IP enforcement is weak.

SWOT Analysis

	India	Minnesota
Strengths	<ul style="list-style-type: none"> • Size of India economy and growth rate (8.5%) • Talent capital, <i>including</i> the educated diaspora. • Young population • Flexibility and adaptability • Reverse brain drain (the returning diaspora) • English language skills • Affordable tuition 	<ul style="list-style-type: none"> • Excellent university education, research, and international programs. • Online training • Manufacturing and supply chain specialization • Diversified economy – healthcare, insurance, technology, biomedical, etc.
Weaknesses	<ul style="list-style-type: none"> • Insufficient numbers of Engineering Ph.D.'s and Masters in India • Infrastructure, water shortage • High attrition rate of employees • Higher education system not adequately broad • Low faculty salary and co-innovation incentives • Weak court protection for IP 	<ul style="list-style-type: none"> • Higher labor costs. • Low cultural awareness and diversity • Low interest and enrollment in S&T • Approaching baby boomer retirement – knowledge loss
Opportunities	<ul style="list-style-type: none"> • R&D solutions drive manufacturing value • Entrepreneurial off-shoots from academia • Growing middle class • Virtual universities 	<ul style="list-style-type: none"> • Affluent society demanding differentiated products • Grow globally by leveraging R&D experience
Threats	<ul style="list-style-type: none"> • China has more Ph.D.'s and Masters • Services reliant on global economy • Regional political instability • Public health crisis • Diminished labor arbitrage due to exchange rate and increasing wages 	<ul style="list-style-type: none"> • Reverse brain drain of international graduates • US recession

Company Overview

Company	Leading	Opportunity (with MN)
IBM – India Research Lab	R&D in services and analytics	Scheduling/optimizing infrastructure repairs Relationship with U of M
3M Innovation Center	Product Development Flexibility to adapt to local markets	Collaboration on product development Knowledge transfer
Honeywell Technology Solutions	Linux and Java based Systems & Controls	Security\Communications and medical diagnostics
SAP Labs	SME Solutions – Business by demand, Mobile solutions for ERP	Partner with U of M computer sciences and IT departments
Innovation Center (SID) at IISC	IT and Biotech Academia industry collaboration	UMN office for technology commercialization

Company Overview – Our Findings

- Group 2 visited IBM in Delhi and Bangalore, 3M in Bangalore and IISC center for innovation at Bangalore.
- 3M notes huge growth potential by localizing products for the vast Indian market.
- Need to package products based on Indian requirements/use is imperative.
- R&D is not the traditional kind like the U.S., but treated from an Indian perspective.

Recommendations

Recommendation	Who	What and When	How
Minn Company: Leverage or grow your brand.	Marketing	Start as soon as you enter India. Make sure you stand behind your corporate ethics and policies.	Market, make products localized to help sell the brand
Minn Company: Make knowledge management a discipline.	IT, R&D, CIO	Start before you move to India and make sure it is leveraged with new initiatives.	Knowledge Mgmt System
Minn Company: Provide mentoring and collaboration.	HR, Related roles (scientists, engineers)	Leverage experienced scientists as SMEs and more junior scientists for new ideas and challenging the norm.	Knowledge Mgmt system, Brown Bag sessions
Minn Company: Provide incentives/benefits that are pertinent to Indian culture.	HR	Need to be established before starting in India. Compare to other companies for competitive potential.	Know the culture to adjust benefits effectively: free lunch, busing to and from work, competitive salaries

Recommendations

Recommendation	Who	What and When	How
<p>Minn Company: Capitalize on ongoing trend of reverse brain drain.</p>	<p>HR, Recruiting dept, Head Hunters</p>	<p>Start before needed.</p>	<p>Advertisement, word-of-mouth and recommendations, leverage universities.</p>
<p>Minn Company: Complement off-shored R&D centers with Minnesota R&D organizations. Win-Win.</p>	<p>Partners</p>	<p>Ongoing</p>	<p>Establish partnerships to ensure collaboration.</p>
<p>Minn Company: Ensure language and culture training are provided.</p>	<p>HR</p>	<p>Start early so that the sharing of knowledge and ideas is easier. Need to relate at a basic level, at the minimum.</p>	<p>Training programs, immersion. Ensure language and culture training are provided.</p>



Recommendations

Recommendation	Who	What and When	How
<p>Indian Govt/Educational Inst: Fund collaborative efforts between industry and educational institutions (such as innovation centers).</p>	Indian government	3 – 5 years	Partner with successful programs
<p>Indian Govt/Educational Inst: Provide market-based incentives for students and faculty in Ph.D. programs</p>	Indian government	Start immediately	Explore funding opportunities
<p>Indian Govt/Educational Inst: Provide further incentives for Indian expatriates, particularly Ph.D.'s with industry experience to return to India</p>	Indian government	Start immediately	Establish tax and other benefits for qualified professionals and businesses



Recommendations

Recommendation	Who	What and When	How
<p>Minn Educational Institutions: Initiate educational exchanges – such as seminars and study abroad programs – for knowledge sharing and collaboration.</p>	<p>University of Minnesota, private colleges</p>	<p>1-3 years.</p>	<p>Establish contacts through Indian educational institutions.</p>
<p>Minn Educational Institutions: Sponsor consortia focused on international collaboration between universities or joint Ph.D. programs. Seek industry sponsors.</p>	<p>University of Minnesota, private colleges</p>	<p>2-4 years.</p>	<p>Establish contacts through Indian educational institutions.</p>
<p>Minn Educational Institutions: Offer online curricula to Indian students.</p>	<p>University of Minnesota, private colleges</p>	<p>1-2 years.</p>	<p>Tailor distance learning to Indian market demands. Explore options.</p>
<p>Think Global</p>	<p>All</p>	<p>Now</p>	<p>Keep learning</p>



Acknowledgements

- Group 2 would especially like to thank:
 - Senior Managers at IBM Research Innovation Services in New Delhi and Bangalore, who generously provided us with considerable knowledge and insights during an interview on March 27, 2008 and April 3rd 2008.
 - All of IIT New Delhi and Professors Sushil and Momaya
 - All of IISc and Professor Bala Subrahmanya
 - All of IIM Bangalore and Professor Rishi
 - Senior management at 3M Innovation Center.
 - Prof. C.E. Veni Madhavan , Innovation center, IISC Bangalore.



भारतीय प्रौद्योगिकी संस्थान दिल्ली
Indian Institute of Technology Delhi



Indian Institute of Science
Bangalore, India



Annotated Bibliography

1. Carey, Elizabeth. "University of Minnesota MOT Program - Engineering Work in India." Presented to MOT2008 class on March 14, 2008.
2. Doz, Yves et. al. "Innovation: Is Global the Way Forward?" Booz | Allen | Hamilton and INSEAD, 2006. Available on-line at http://www.boozallen.com/media/file/Innovation_Is_Global_The_Way_Forward_v2.pdf
3. Dutz, Mark A., ed. "Unleashing India's Innovation: Toward Sustainable and Inclusive Growth." Washington, DC: The International Bank for Reconstruction and Development/The World Bank. 2007. Available on-line at <http://siteresources.worldbank.org/SOUTHASIAEXT/Resources/223546-1181699473021/3876782-1191373775504/indiainnovationfull.pdf>
4. Mitra, Raja M. "India's Emergence as a Global R&D Center - an overview of the Indian R&D system and potential." Working Paper R2007:012. Swedish Institute for Growth Policy Studies. E-mail info@itps.se or see www.itps.se. Group2 *highly* recommends this comprehensive, well written study.
5. Money.com. "IBM Launches the IBM Institute for Business Value." 12 March 2008. Available on-line at <http://money.cnn.com/news/newsfeeds/articles/marketwire/0374042.htm>
6. Interview with Group 2 on 3/27/08 (interview notes available on request). Senior Manager with IBM. Research Innovation Services, IBM India Private Limited, India Research Laboratory, 4, Block – C, Institutional Area,
7. Tiwari, Rajnish et. al. "Innovation via Global Route: Proposing a Reference Model for Chances and Challenges of Global Innovation Processes." July 2007, Working Paper No. 49. Published in the "Proceedings of the Second International Conference on Globally Distributed Work" held by Indian Institute of Management, July 25-27, Bangalore, pp. 451-46. Available on-line at http://www.tu-harburg.de/tim/downloads/arbeitspapiere/Working_Paper_49.pdf
8. Interview with Group 2 rep on 4/2/08. Senior Mgmt with 3M Solution Center.

Assess Organization Readiness for “World is Flat”

Decision to Outsource: Assess Organization Readiness

- Ability to manage projects
 - Process Readiness
 - Cultural Readiness



Process Readiness

1. What percentage of your large and complex projects come in on-time and on-budget?
2. What percentage of your staff is PMI-certified or equivalent certification?
3. What percentage of projects are managed through a central program?
4. Does the function and business staff use real-time communications, workflow, and content-sharing tools that support distributed projects?
5. Does your organization follow a standardized develop and maintenance process?
6. Does your organization invest in development process disciplines like the Software Engineering Institute Capability Maturity Model?



Process Readiness

7. Does your company use a standardized and formal requirements definition and review process that introduces rigor in the way that business users can request new requirements or change them?
8. Does your organization rely on Service Level Agreements to establish a meaningful level of mutual responsibility for internal projects?
9. What percentage of projects are managed as a portfolio – measured comparatively as to their costs and business value?
10. Does your organization follow a formal sign-off process between business and project releases for system specifications and final delivery?



Cultural Readiness

1. How cost competitive are you compared with your top 3 competitors?
2. Do you have corporate operation in developing countries?
3. Are business sponsors interested in going offshore?
4. What is your firm's tolerance for change and risk?
5. How much does your company spend on IT, Engineering (for example) as a percentage of total revenues?
6. Does your company pursue or adhere to ISO, Six Sigma, or other process/quality methods?
7. Is your IT or Engineering department distributed or centralized?
8. What is your company's use of outsourcing?
9. What percentage of your workforce is unionized?
10. To what extent are your business processes regulated?



Example: Decision to Outsource

Rating of Importance to Customer	5	5	6	9	8	4	6	5	7	3	10	
Process Inputs	Pre-existing capability and technical experience.	Training requirements.	Level of interaction with other team members.	Scope work.	Data transfer capabilities	Project size/duration.	Onsite support & project management requirements.	Documentation requirements.	Business criticality and schedule.	Intellectual property concerns.	Resource availability for the specific project	Total
Onsite	9	9	5	4	10	5	6	5	7	4	2	398
Offshore	5	4	4	8	9	9	9	9	9	3	10	520

Sourcing Strategy Matrix

Where Do We Invest

	Strategic and we are world leaders	Strategic, BUT we lack the technology and scale to compete effectively
Highly Strategic Capabilities	Invest Focus investment and talent. Treat internal source as preferred supplier	Collaborate Explore Options such as joint venture, licensing, equity stake. Be a "Smart Customer."
Less Strategic Capabilities	Cash Cow Invest as long as very profitable	Outsource
	Not Strategic, but very profitable	Commodity, and we have no competitive advantage

The Process

- Benchmarking
 - E.g., GE, Infosys, Tata, etc. in India
- Define mission/vision and objectives
- Find a partner to work with us to recruit talent and locate a facility
- Hire an Organization Development consultant
- Develop organization structure (Board of Directors, identify a Managing Director, recruit functional leaders)
- Governance (strategic planning and functional direction)
- Develop project tracking systems, receive work commitments
- Develop financial systems
- Implement IT structure
- HR policies for XPAT assignments
- Opening ceremonies...

SWOT Analysis: India

Strengths

Weaknesses

Internal

Opportunities

Threats

External





★ China

Part III*: Education, Patents, Industry, Energy & more

S. Massoud Amin, D.Sc.

Director and Honeywell/H.W. Sweatt Chair in Technological Leadership

University Distinguished Teaching Professor

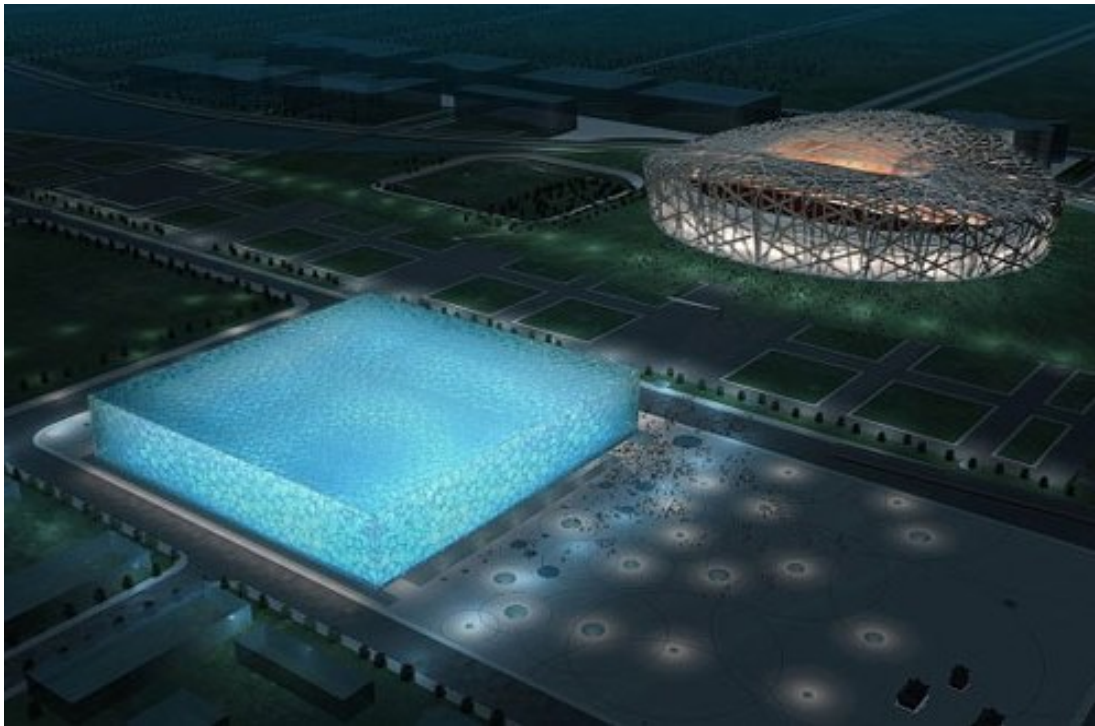
Professor of Electrical & Computer Engineering

Presentation at the Rochester Signature Series, October 2009

*Parts of this presentation were developed for a graduate course at CDTL's Management of Technology (MOT) program on Science and Technology Policy (MOT 8920). Considerable input and support from the students in the MOT class of 2006 is gratefully acknowledged.

Beijing Olympics

- Stunning architecture
- Birds nest stadium & swim center
- Digital building

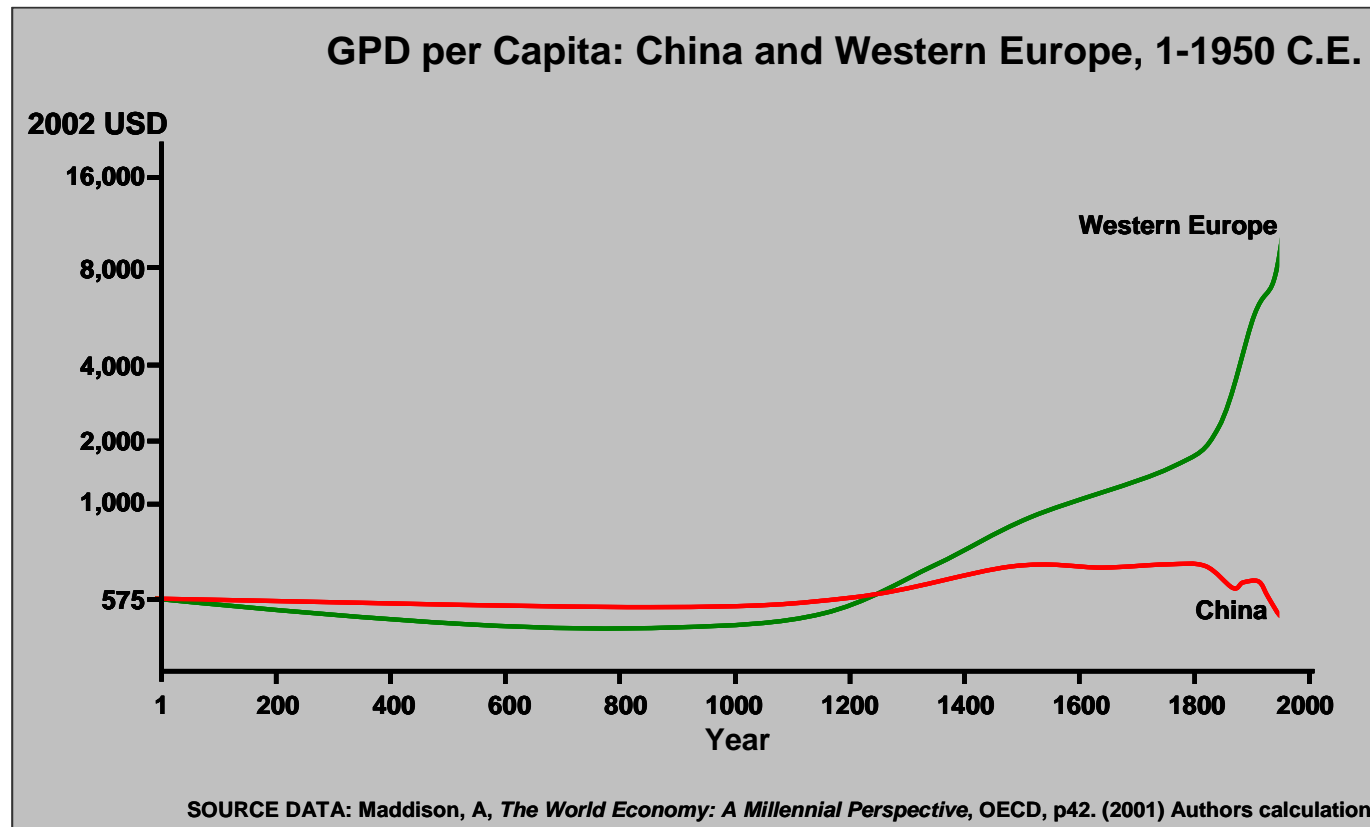


<http://www.neatorama.com/wp-content/uploads/2007/03/watercube.jpg>

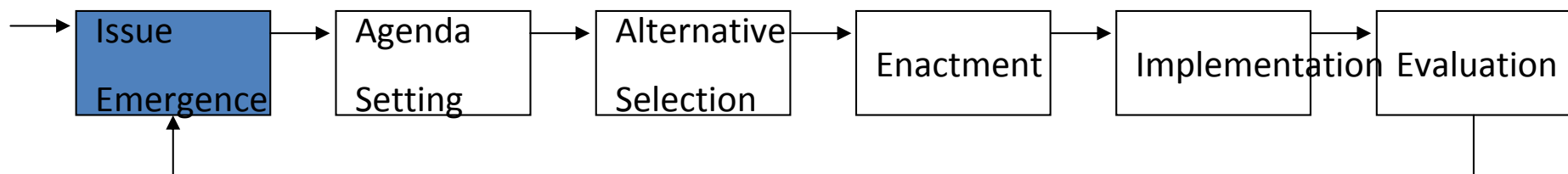


<http://www.globalconstructionwatch.com/wp-content/uploads/2008/03/digital-beijing-building05.jpg>

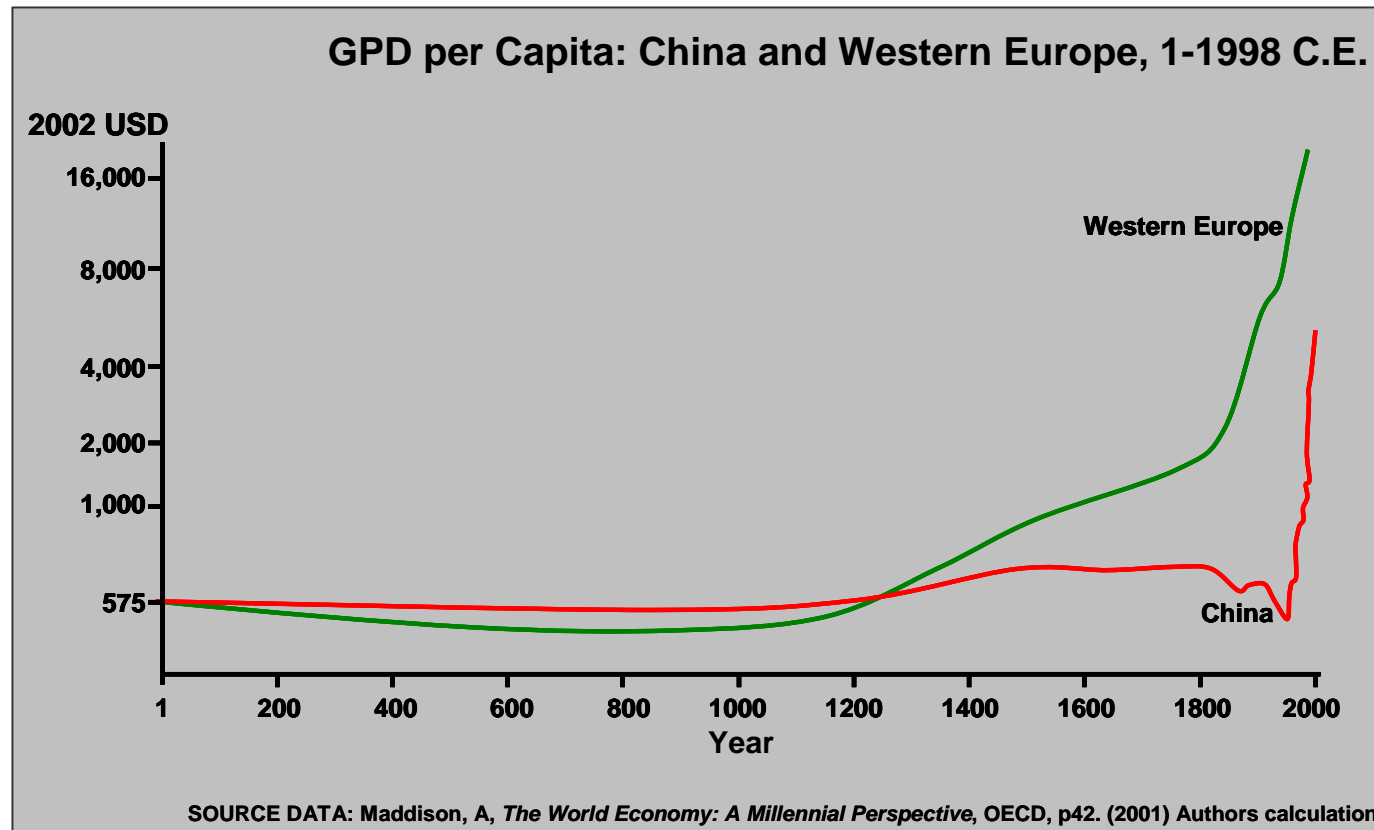
Chinese Economic Development Lags



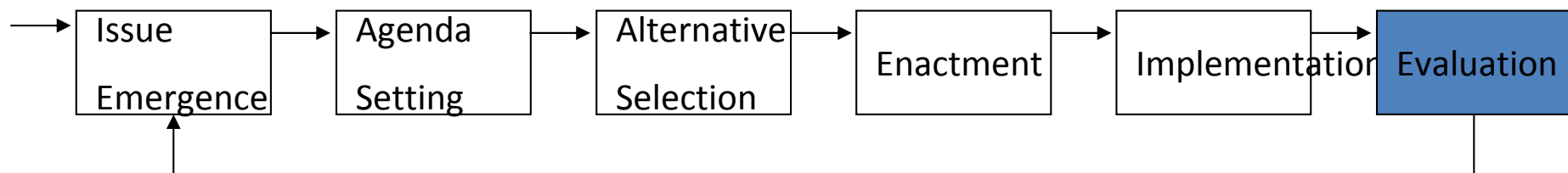
In Europe - Technologies like Printing, Gunpowder & Compass and the Industrial Revolution created dramatic inflections in the continental economy



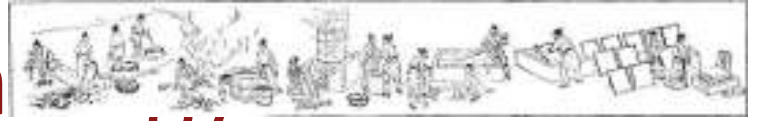
Chinese Economic Development Surges



Technologies including Atomic science, Semiconductors, Computer technology, Lasers and Automation create turnaround in the Chinese economy



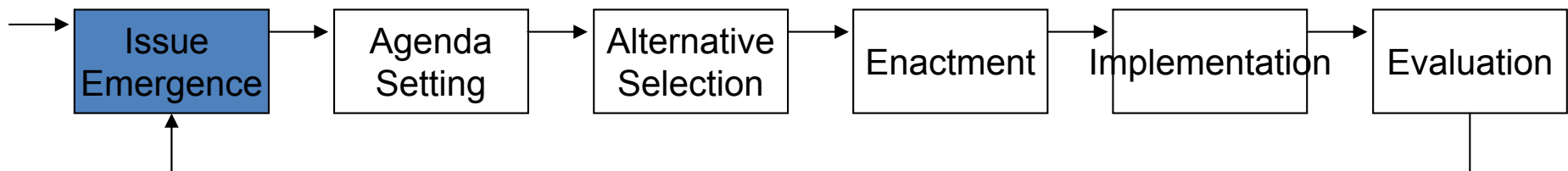
Chinese Techn



福	Nanotech		<20 th Century BCE
	福	Therapeutic Colloidal Au & Ink of FeOx and HgS	
福	Decimal System		15 th Century BCE
福	Cast Iron		3 rd Century BCE
福	Paper		110 CE
福	Compass		200 CE
福	Gunpowder		750 CE
福	Arched Bridge Construction		600 CE
福	Printing		581 CE
福	Military Rocketry		1044 CE
福	Toilet Paper		1391 CE
福	Global Sea navigation		1421 CE



- Chinese technology outpaced Western advances by centuries.
- With a historical leading technology position, why did China fall behind after the industrial revolution of the 19-20th centuries?



Background on China

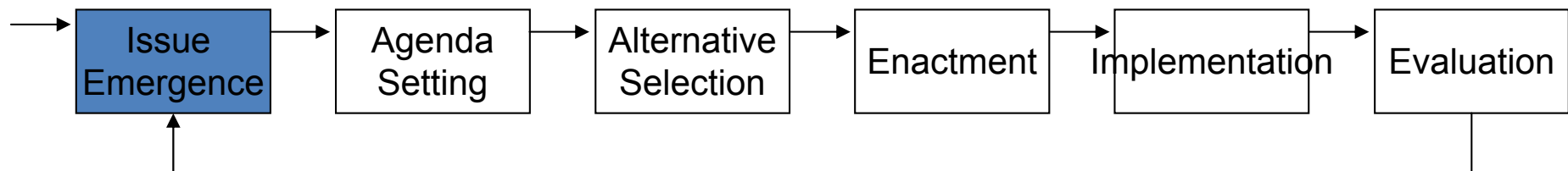


- Communist country with current structure founded in 1949.
- The world's fourth largest country in area with 9,596,960 square kilometers (3,705,407 square miles) of total land and water.
- Contains the world's largest population with approximately 1.3 billion people.
- Currently produces 1.42 trillion kWh and exports 10.3 kWh of electricity.
- Currently produces 3.3 million barrels per day and consumes 4.57 million barrels per day of oil.
- Currently produces 30.3 billion cubic meters and consumes 27.4 billion cubic meters of natural gas.
- Second largest energy consumer after the United States.
- Currently have 263 million wired and 269 cellular phone lines.
- Has the second highest rate of Internet users (79.5 million), just behind the United States (159 million).
- Currently spends about \$60 billion on military expenditures.
- Available army of 380 million people with an additional 12.5 million reaching age annually.

Issue Emergence - 1976



- Cultural Revolution Over
- Death of Mao Tse-Tung



Agenda Setting – 1976-1978

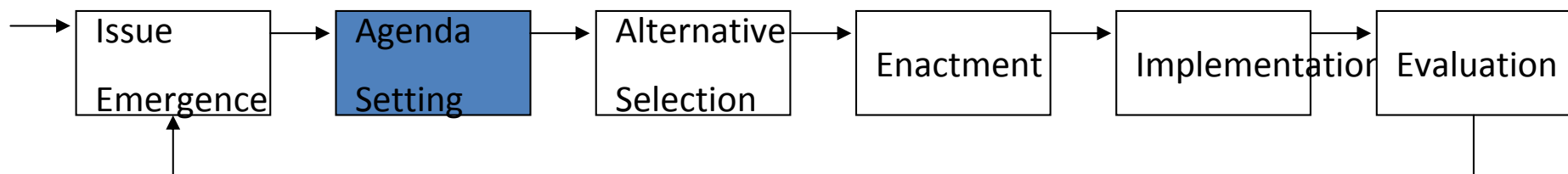
- New Premier Deng Xiaoping establishes a radical new direction for the country



- “Four Modernizations” would command improvements in select key segments of the Chinese economy

Agriculture – Industry – Military – Science & Technology

Johnson, C., *Foreign Affairs*, Fall78, Vol. 57 Issue 1, p125-137



Agenda Setting – 1976-1978

- “Four Modernizations”

Agriculture

Industry

Military

Science & Technology

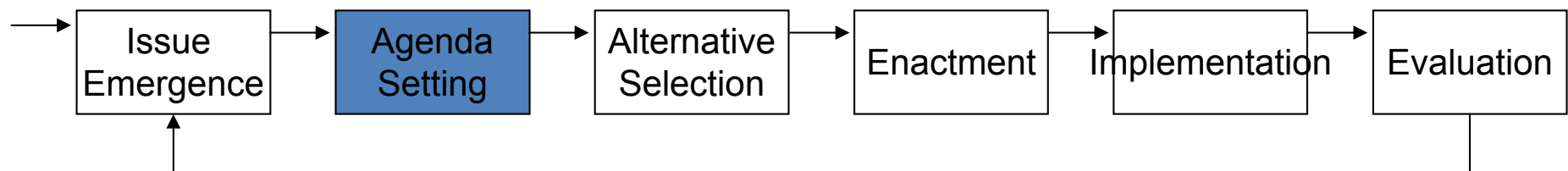
"the central committee has stipulated that a system of individual responsibility for technical work be established in scientific research institutes and that the system of division of responsibilities among institute directors under the leadership of party committees be set up." Xinhua General News Service, 21 March 1978

Johnson, C., *Foreign Affairs*, Fall78, Vol. 57 Issue 1, p125-137



Deng Xiaoping

'As long as it catches mice, it does not matter whether the cat is black or white.'



Alternative Selection – 1979-1982

- “The *New Long March*”
- “The *Great Leap Westward*.”
- “*Revolution within a revolution*.”
- Market socialism - Zhao Ziyang

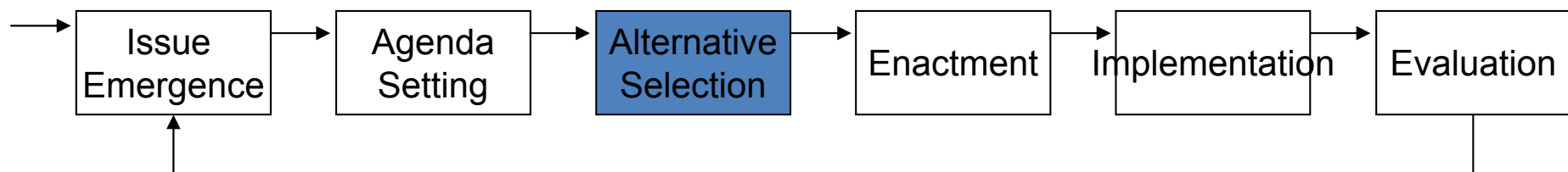


Five Golden Blossoms...

Atomic science – Semiconductors - Computer technology- Lasers- Automation

Yunag-Hwan Jo “China's Future and Ourselves” [Vital Speeches of the Day](#); Vol. 45 Issue 10, p302, 3/1/79

- Premier Zhao Ziyang; National Science Awards, 1982.
“*uneven development...rivalry...poor management*”





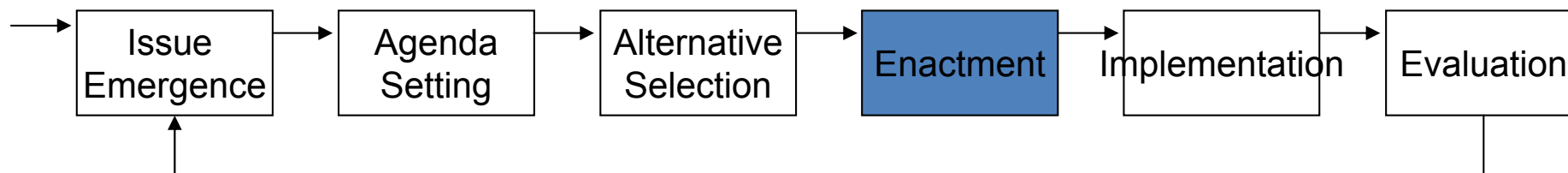
Peoples Republic of China Science and Technology Mission



<http://www.most.gov.cn/>

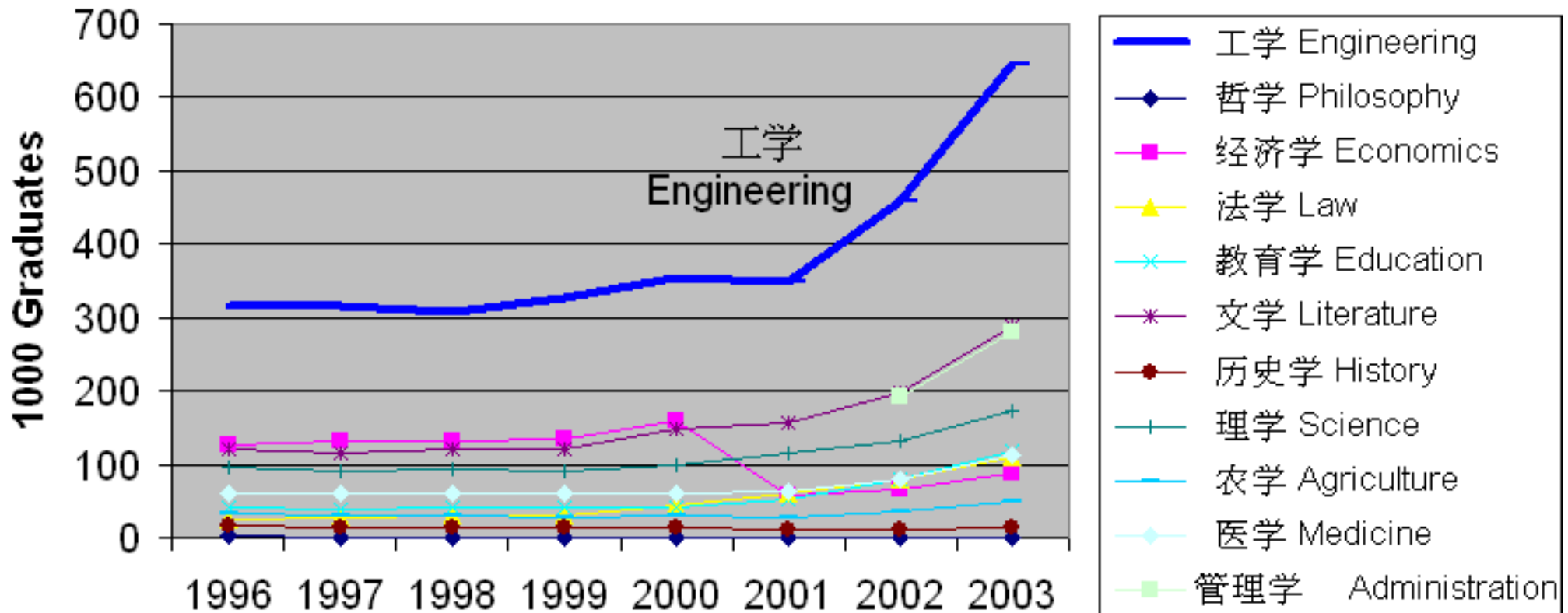
- To promote and improve innovation
- To strengthen fundamental research and Hi-tech Development
- To guide the transfer of science and technology achievements
- To ensure bilateral international science and technology cooperation and exchange
- To take charge of management of science and technology

Can a centralized Science & Technology Mission of a non-democratic nation succeed?



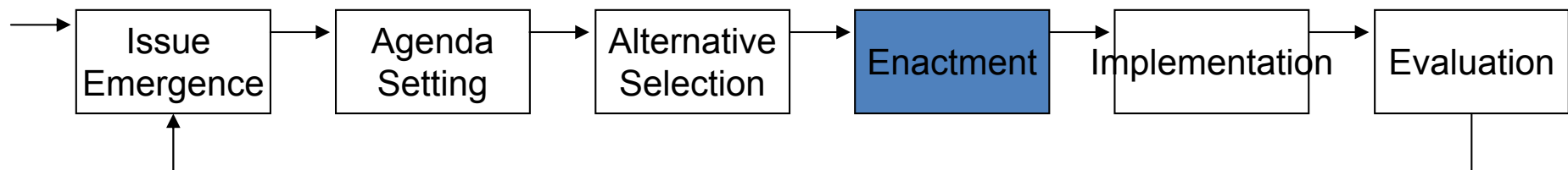
“Revitalizing the nation through science and education”

Trend of number of graduates in high education institutions in China



China science and technology statistics

Year



S&T Policies and Regulations

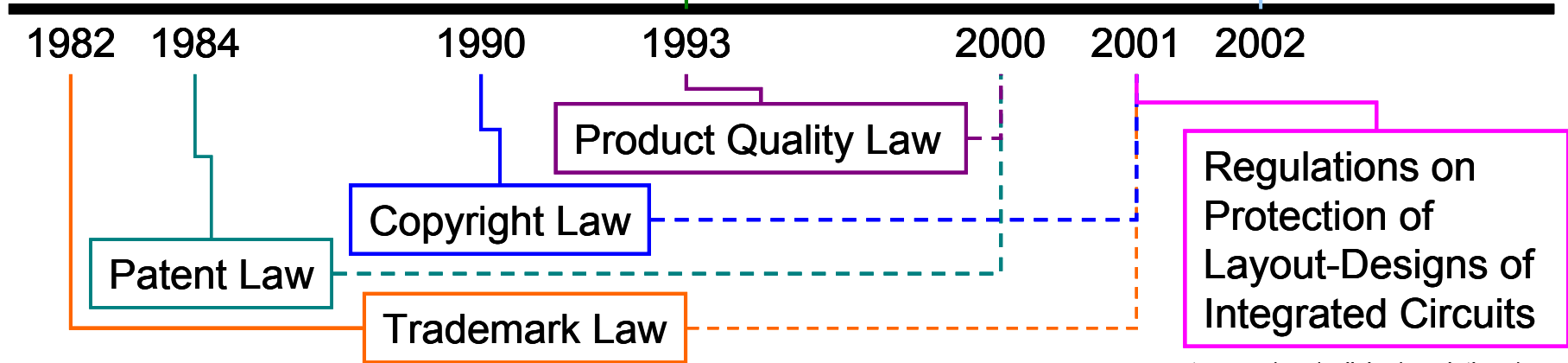
— Created
 ----- Last revised

Law on Science and Technology Progress

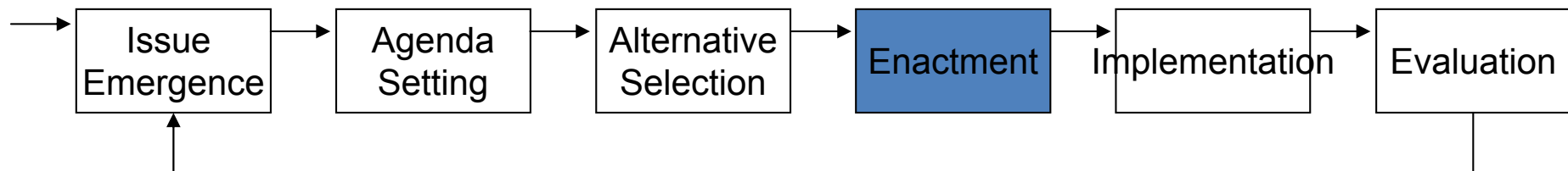
- The State Council formulates programs to promote S&T progress and uses S&T as the primary productive force to improve economic construction.
- Promote high-tech research and industries.
- Ensure the continuous and steady development of basic research and applied basic re-search (\$).
- Raise the social status of scientific and technical workers.

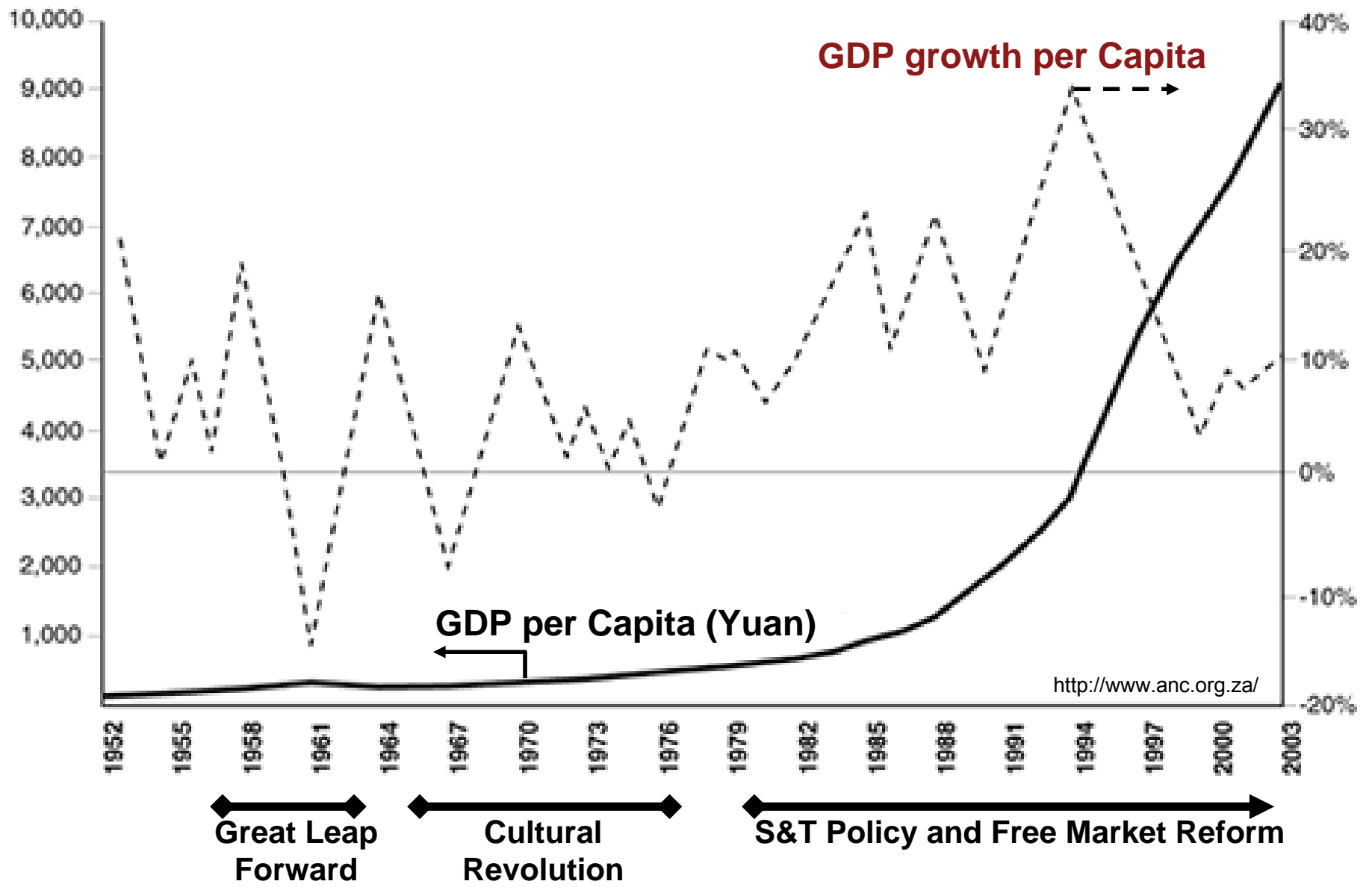
Law on Popularization of Science and Technology

- Through science, education and the strategy of sustainable development, redoubling the efforts to popularize science and technology, raising the citizens' scientific and cultural level and promoting economic and social progress.
- Make it easy for the general public to understand, accept and participate.



www.most.gov.cn/eng/policies/regulations/





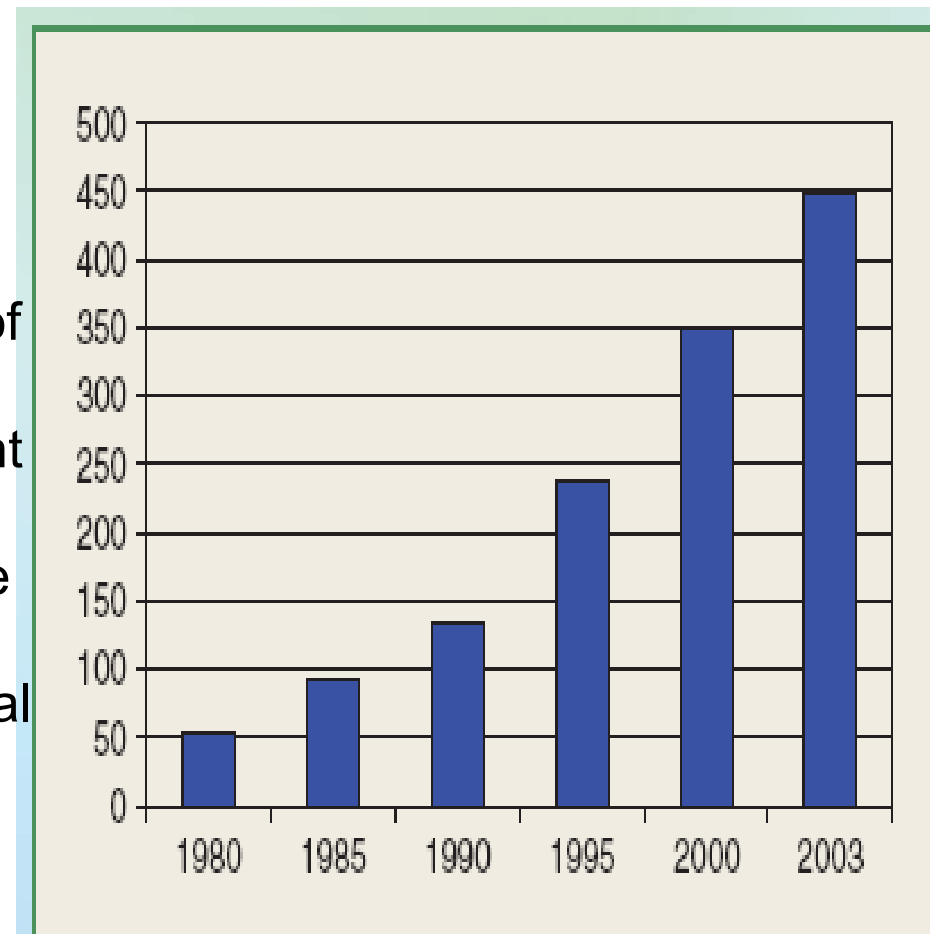
GDP in billions of U.S. dollars (indexed 1980 \$)

Since the economic reform in 1980, China has experienced unprecedented economic growth: GDP has jumped more than 800%.

The corresponding growth in primary energy consumption has increased only 278%.

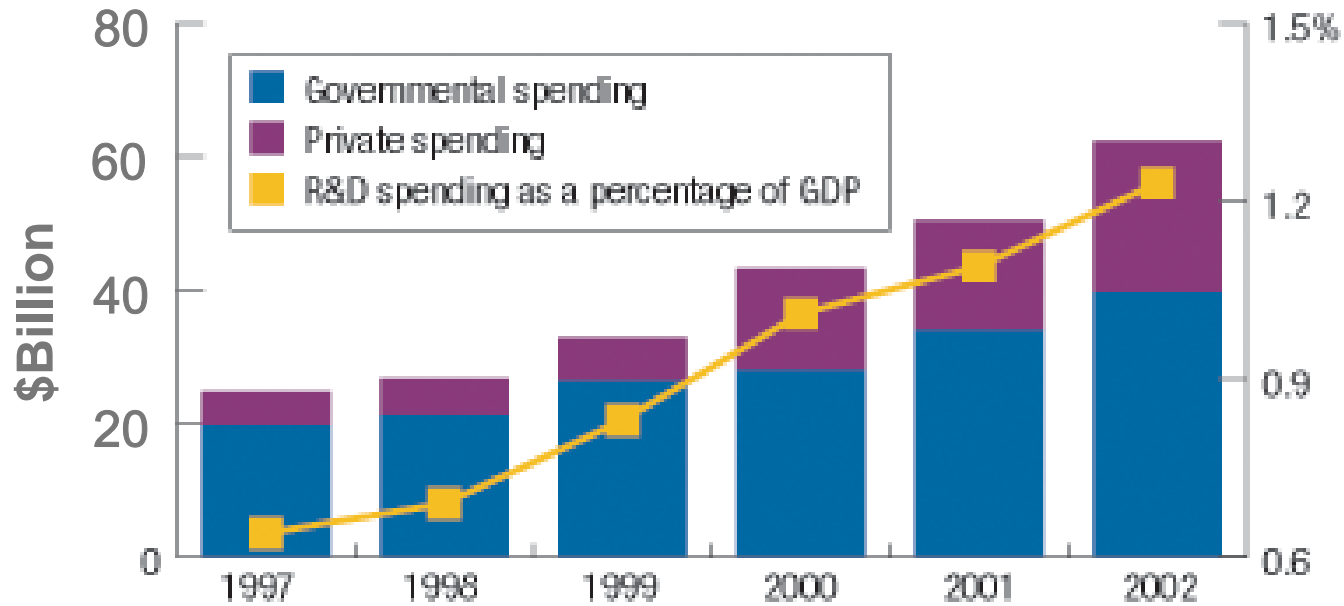
The energy intensity, measured in terms of energy consumption in kilogram of coal equivalent (kgce) per economic output in dollar of Chinese yuan, dropped from 1.33 to 0.46. There are many factors contributing to this improvement in the more efficient usage of energy.

A major one may be attributed to the fact that the share of electricity utilization (a more efficient means of energy usage in most cases) in the total energy consumption has more than doubled, up from 20.6% to 43.8%. As a result, the growth in electricity has surged 634% since 1980. This figure shows the growth in the economy:



Implementation – Chinese R&D Spending

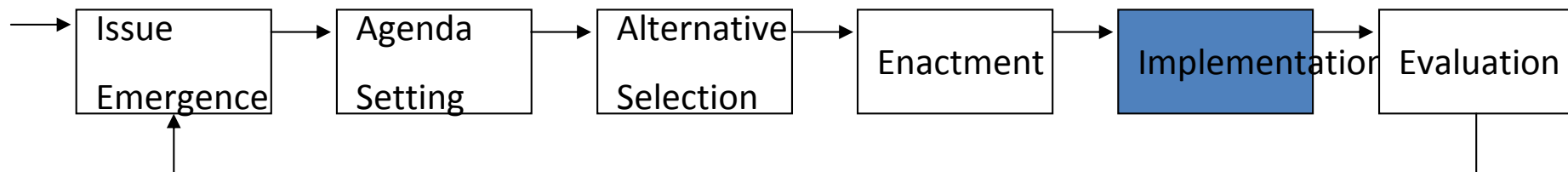
20% Compound Annual Growth Rate (CAGR) in R&D Expenditures:1991–2002



Chinese yuan were converted at the official Bank of China exchange rate, 8.28 yuan per U.S. dollar.

SOURCE: MINISTRY OF SCIENCE AND TECHNOLOGY, PEOPLE'S REPUBLIC OF CHINA

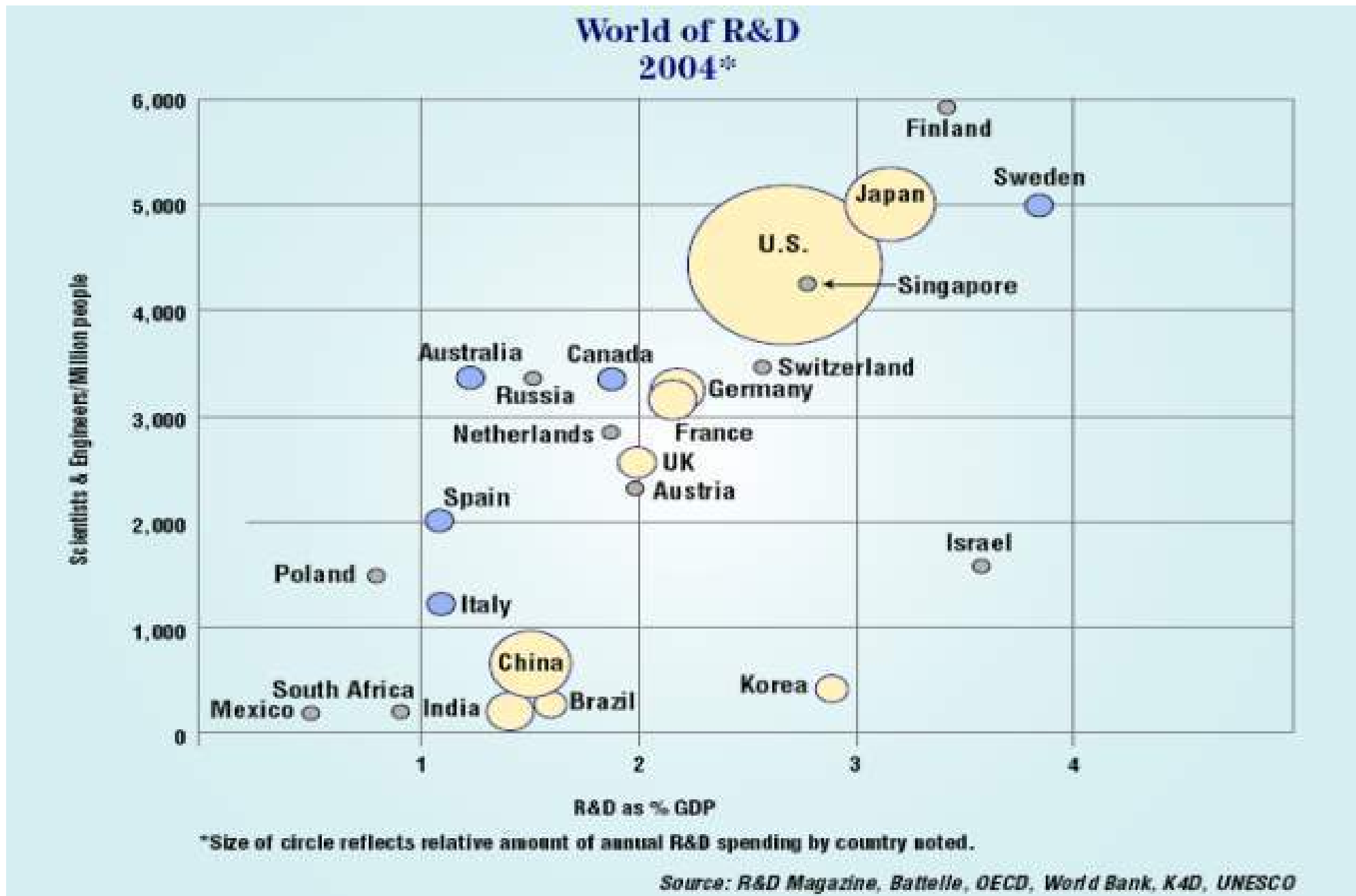
Chinese R&D expenditure is 3rd largest globally behind US & Japan



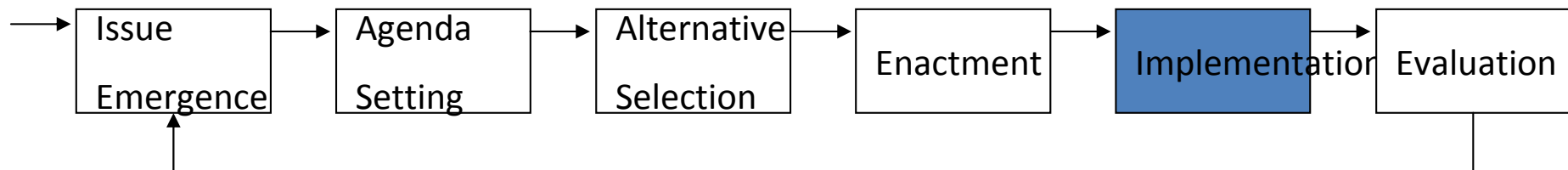
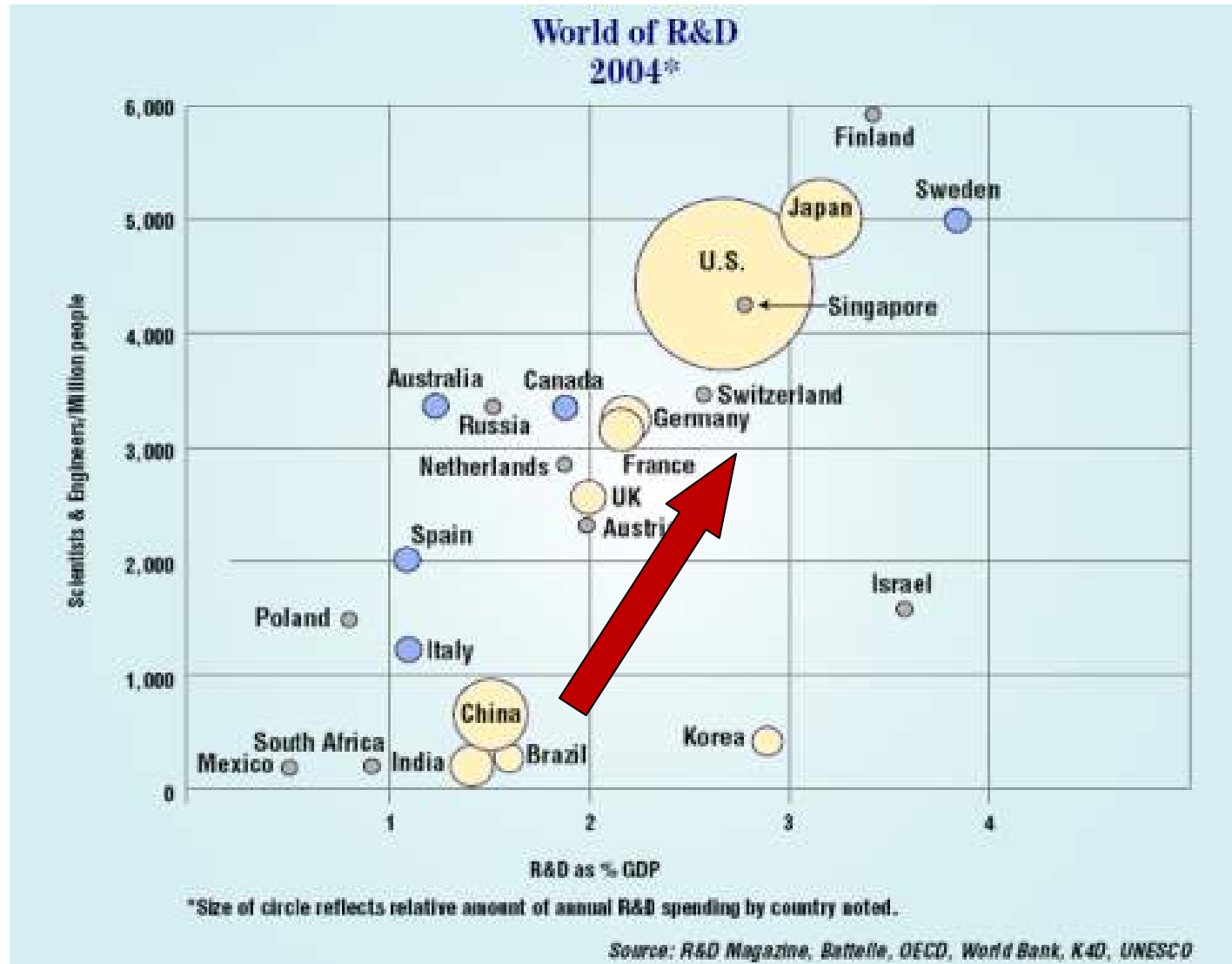
Macroeconomic Rationale

1. Endogenous growth models - theoretical support for domestic technology creation
2. $Y = f(R, K, H)$, where:
 - $Y = \text{GDP}$
 - $R = \text{R\&D}$
 - $K = \text{physical capital}$
 - $H = \text{human capital}$
3. Velocity and proportion of R, K, H: determinants of success

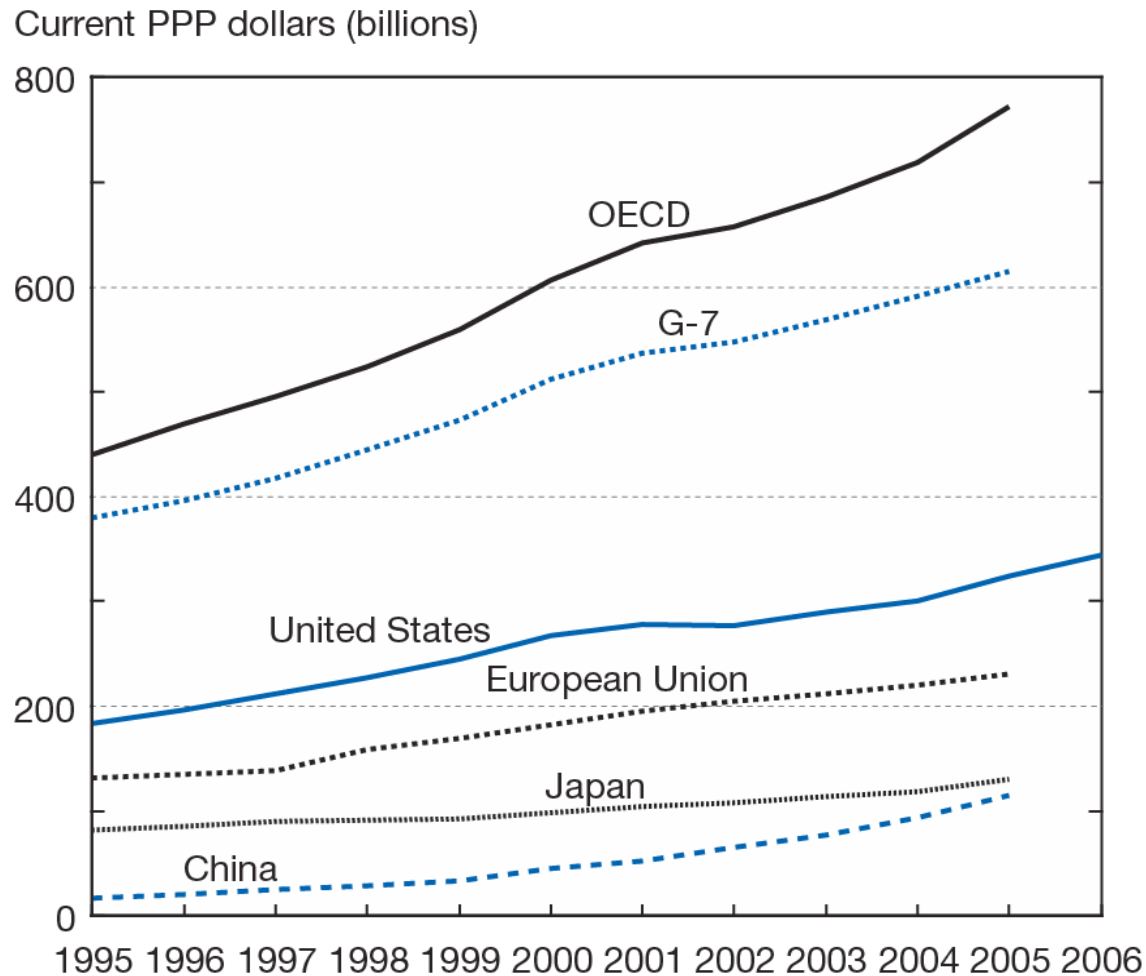
Global R&D Potential (2004 data)



Global R&D Potential 2004



Gross domestic expenditures on R&D, by selected region/country: 1995–2006

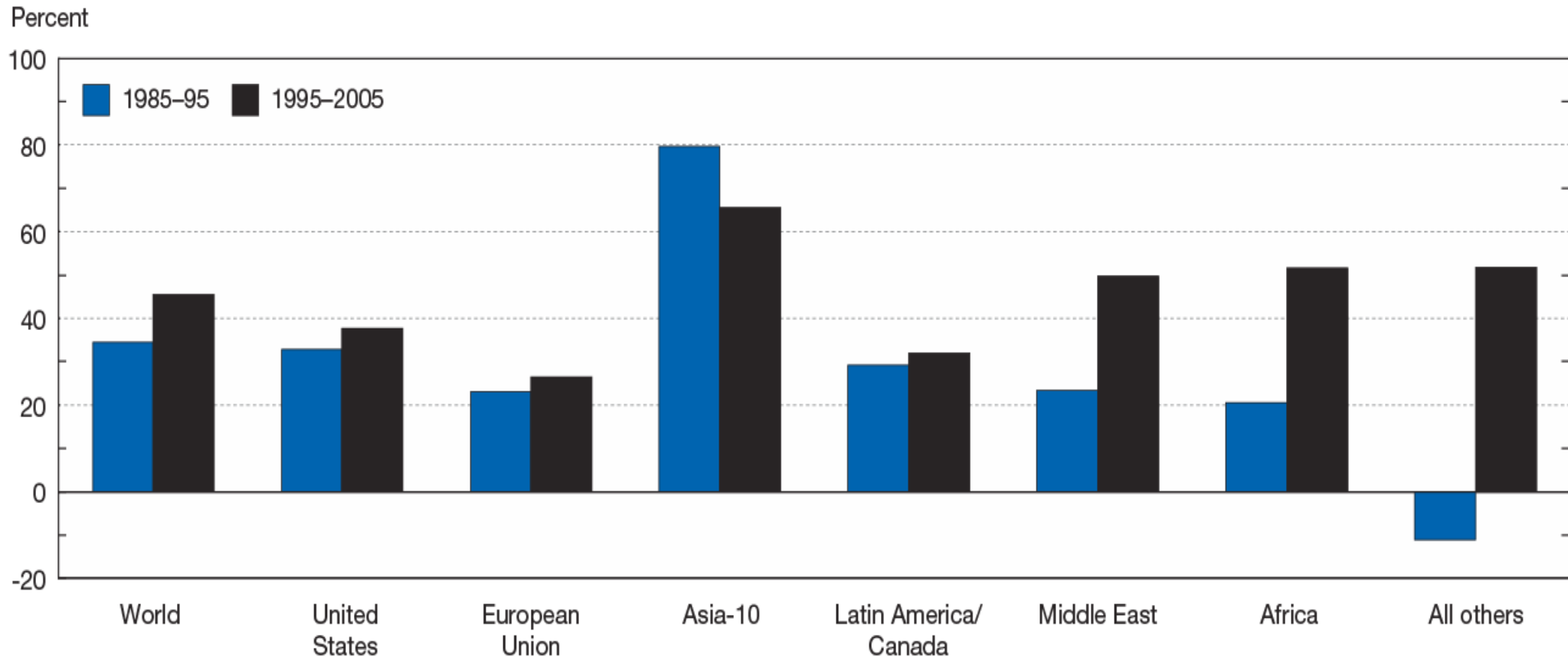


OECD = Organisation for Economic Co-operation and Development;
PPP = purchasing power parity

NOTE: European Union (EU)-25 from 1998–2000, EU-27 thereafter.

Source: NSF, Science and Engineering Indicators- 2008

Real GDP growth, by region/country: 1985–95 and 1995–2005

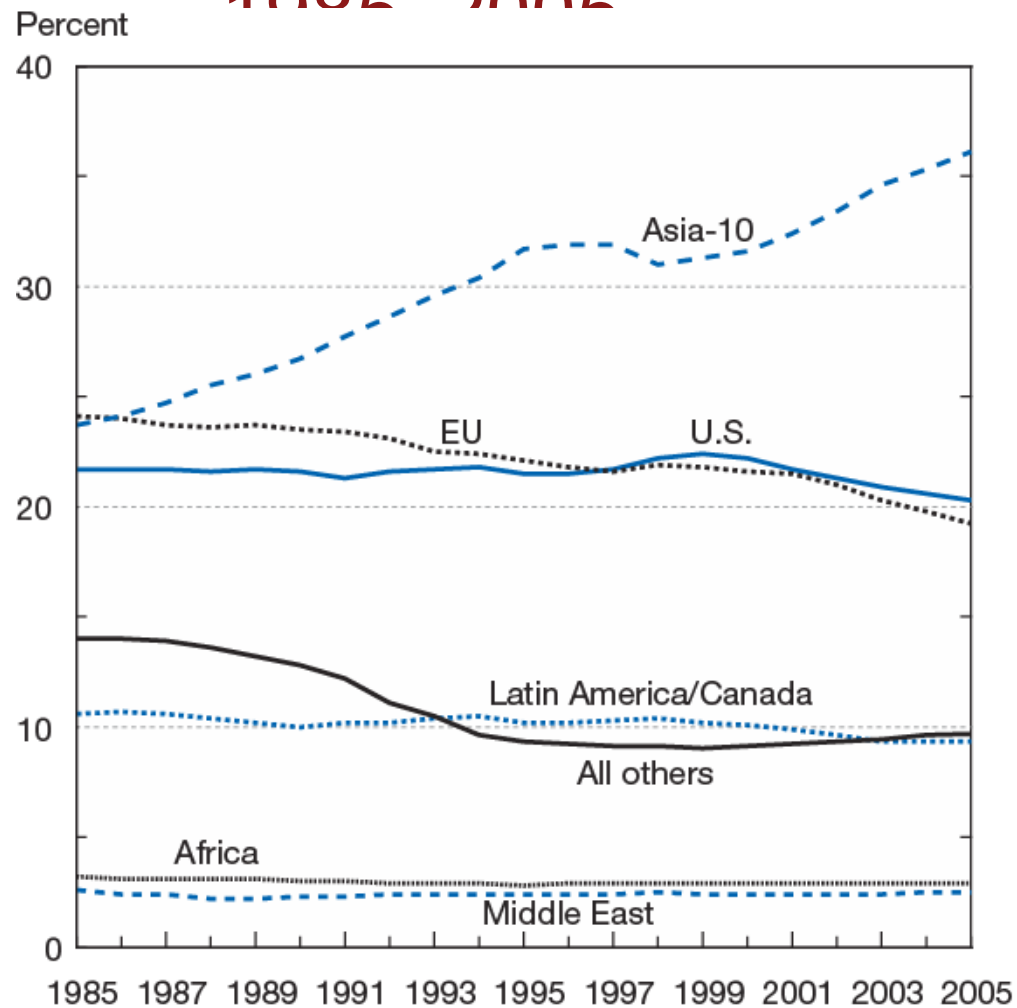


GDP = gross domestic product

NOTES: Asia-10 includes China, India, Indonesia, Japan, Malaysia, Philippines, Singapore, South Korea, Taiwan, and Thailand. China includes Hong Kong.

SOURCE: National Science Board, *Science and Engineering Indicators-2008*

World GDP shares, by region/country: 1985 2005

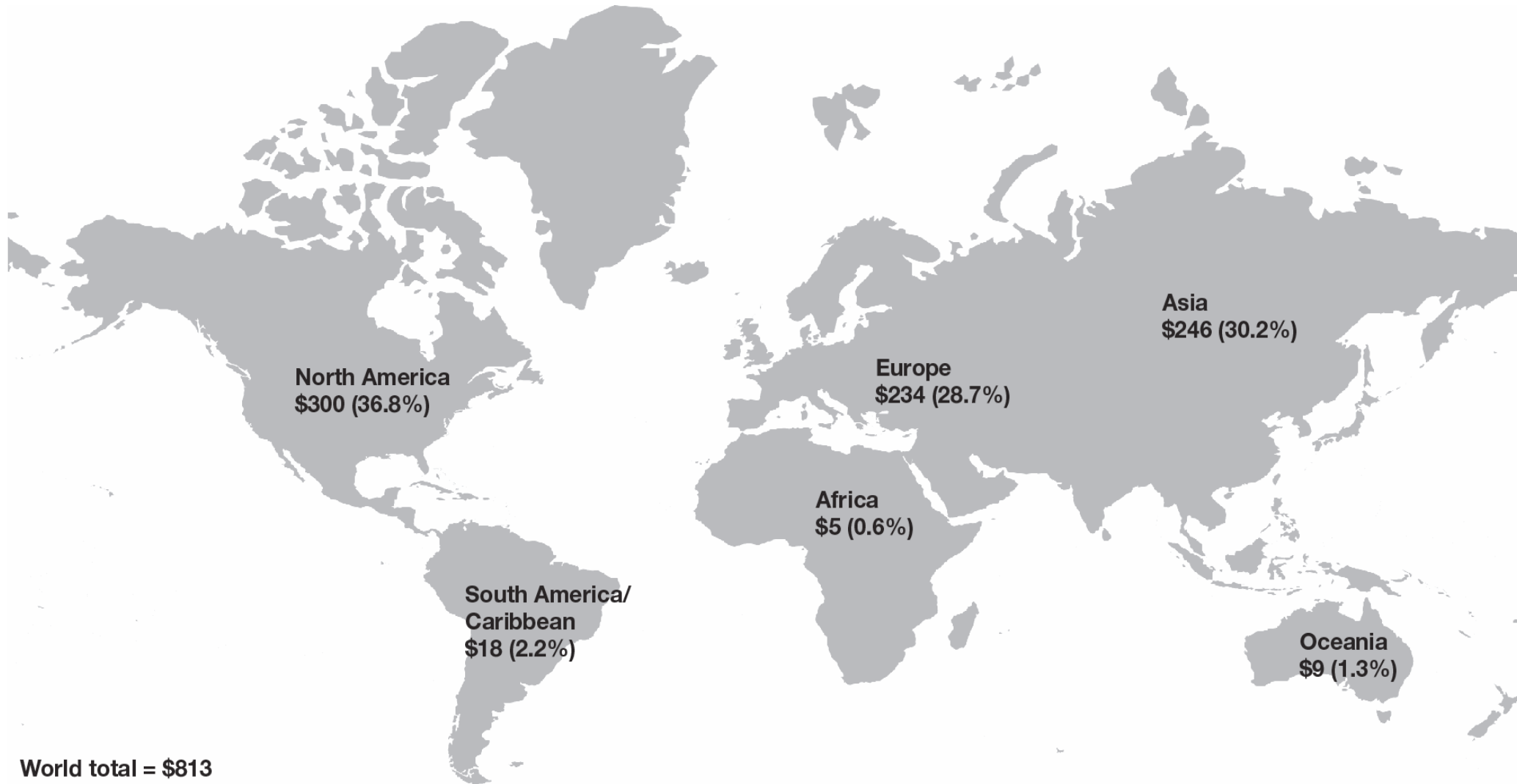


EU = European Union; GDP = gross domestic product

NOTES: Asia-10 includes China, India, Indonesia, Japan, Malaysia, Philippines, Singapore, South Korea, Taiwan, and Thailand. China includes Hong Kong.

SOURCE: National Science Board, *Science and Engineering Indicators-2008*

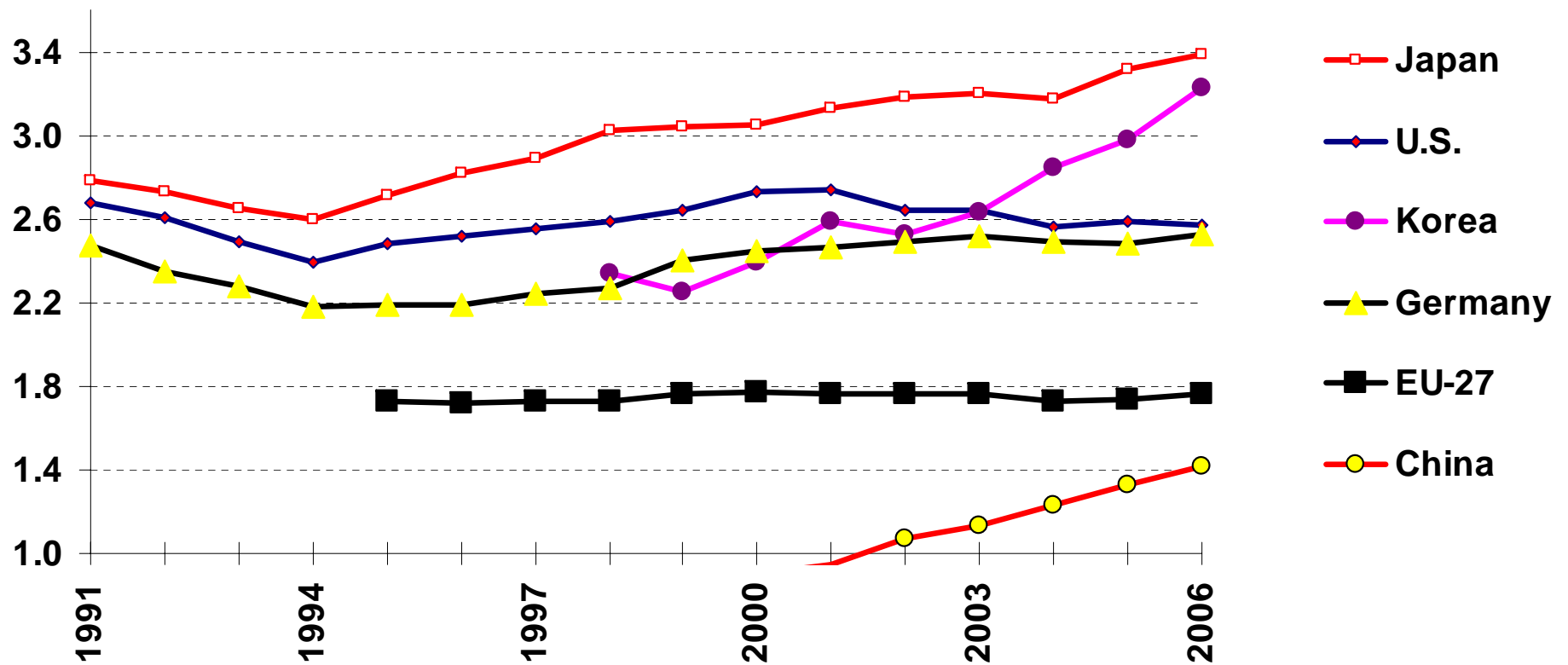
Estimated R&D expenditures and share of world total, by region: 2002



NOTES: R&D estimates from 91 countries in billions of purchasing power parity dollars. Percentages may not add to 100 because of rounding.

Source: NSF, Science and Engineering Indicators- 2008

Total National R&D as % of GDP, 1991-2006



Source: National Science Foundation, National Patterns of R&D Resources and OECD, Main Science and Technology Indicators. Data not available for all nations for all years. AUGUST '08 © 2008 AAAS

Science and Engineering Indicators 2008:

- In 2002 (the latest year of available data), global R&D expenditures totaled at least \$813 billion, of which 45% was accounted for by the two largest countries in terms of R&D performance, the United States and Japan.
 - The R&D performance of Organisation for Economic Cooperation and Development (OECD) countries, which accounted for \$657 billion in 2002, grew to \$726 billion in 2004. The G-7 countries performed more than 83% of OECD R&D in 2004. Outside of the G-7 countries, South Korea is the only country that accounted for a substantial share of the OECD total.
 - More money was spent on R&D activities in the United States in 2004 than in the rest of the G-7 countries combined.
 - In 2004, Brazil performed an estimated \$14 billion of R&D, and India performed an estimated \$21 billion in 2000, making it the seventh largest country in terms of R&D in that year, ahead of South Korea.
 - China had the fourth largest expenditures on R&D in 2000 (\$45 billion), which increased in 2005 to an estimated \$115 billion. Given the lack of R&D-specific exchange rates, it is difficult to draw conclusions from these absolute R&D figures, but the country's nearly decade-long, steep ramp-up of R&D expenditures appears unprecedented in the recent past.

<http://www.nsf.gov/statistics/seind08/toc.htm>

<http://www.nsf.gov/statistics/seind08/slides.htm>

<http://www.nsf.gov/statistics/seind08/c4/c4h.htm#c4h6>

Research and development
expenditure as % of GDP (most
recent) by country

Rank	Countries	Amount ▼
# 1	<u>Israel:</u>	4.46 %
# 2	<u>Sweden:</u>	3.74 %
# 3	<u>Finland:</u>	3.46 %
# 4	<u>Japan:</u>	3.15 %
# 5	<u>Iceland:</u>	3.01 %
# 6	<u>United States:</u>	2.68 %
# 7	<u>Korea, South:</u>	2.64 %
# 8	<u>Denmark:</u>	2.63 %
# 9	<u>Switzerland:</u>	2.57 %
# 10	<u>Germany:</u>	2.49 %
# 11	<u>Austria:</u>	2.33 %
# 12	<u>Singapore:</u>	2.25 %
# 13	<u>France:</u>	2.16 %
# 14	<u>Canada:</u>	1.93 %
# 15	<u>Belgium:</u>	1.9 %
# 16	<u>United Kingdom:</u>	1.89 %
# 17	<u>Netherlands:</u>	1.85 %
# 18	<u>Luxembourg:</u>	1.81 %
# 19	<u>Norway:</u>	1.75 %
# 20	<u>Australia:</u>	1.7 %
# 21	<u>Slovenia:</u>	1.61 %
# 22	<u>China:</u>	1.44 %
	Weighted average:	0.9 %

Source: NSF, Science and Engineering Indicators-2008



HOW DOES THE U.S. COMPARE?

- The U.S. is still the leading science and technology superpower in R&D investments, but the lead is shrinking.
- The U.S. R&D / GDP ratio compares favorably with other nations, but defense development is a big factor in the U.S.
- Other nations:
 - EU – A plan to reach 3% of EU GDP by 2010, but it won't happen.
 - Korea – R&D growing by 10%+ a year, R&D/GDP ratio surpasses U.S. ratio in 2004 and hits 3%.
 - China – R&D spending grew 20% in 2004 and 25% in 2005; basic research still small, but expanding rapidly.
 - India – Not big in R&D spending yet, but there are plans to boost its R&D capabilities to compete in high-tech industries.

Gross domestic products (GDP) 2007

Source: World Development Indicators database, World Bank, rev. 10/9/2008

<i>Ranking</i>	<i>Economy</i>	<i>(millions of US dollars)</i>
1	United States	13,811,200
2	Japan	4,376,705
3	Germany	3,297,233
4	China	3,280,053
5	United Kingdom	2,727,806
6	France	2,562,288
7	Italy	2,107,481
8	Spain	1,429,226
9	Canada	1,326,376
10	Brazil	1,314,170
11	Russian Federation	1,291,011
12	India	1,170,968
13	Korea, Rep.	969,795
14	Mexico	893,364
15	Australia	821,716
16	Netherlands	754,203
17	Turkey	657,091
18	Belgium	448,560
19	Sweden	444,443
20	Indonesia	432,817
21	Poland	420,321
22	Switzerland	415,516
23	Norway	381,951
24	Saudi Arabia	381,683
25	Austria	377,028



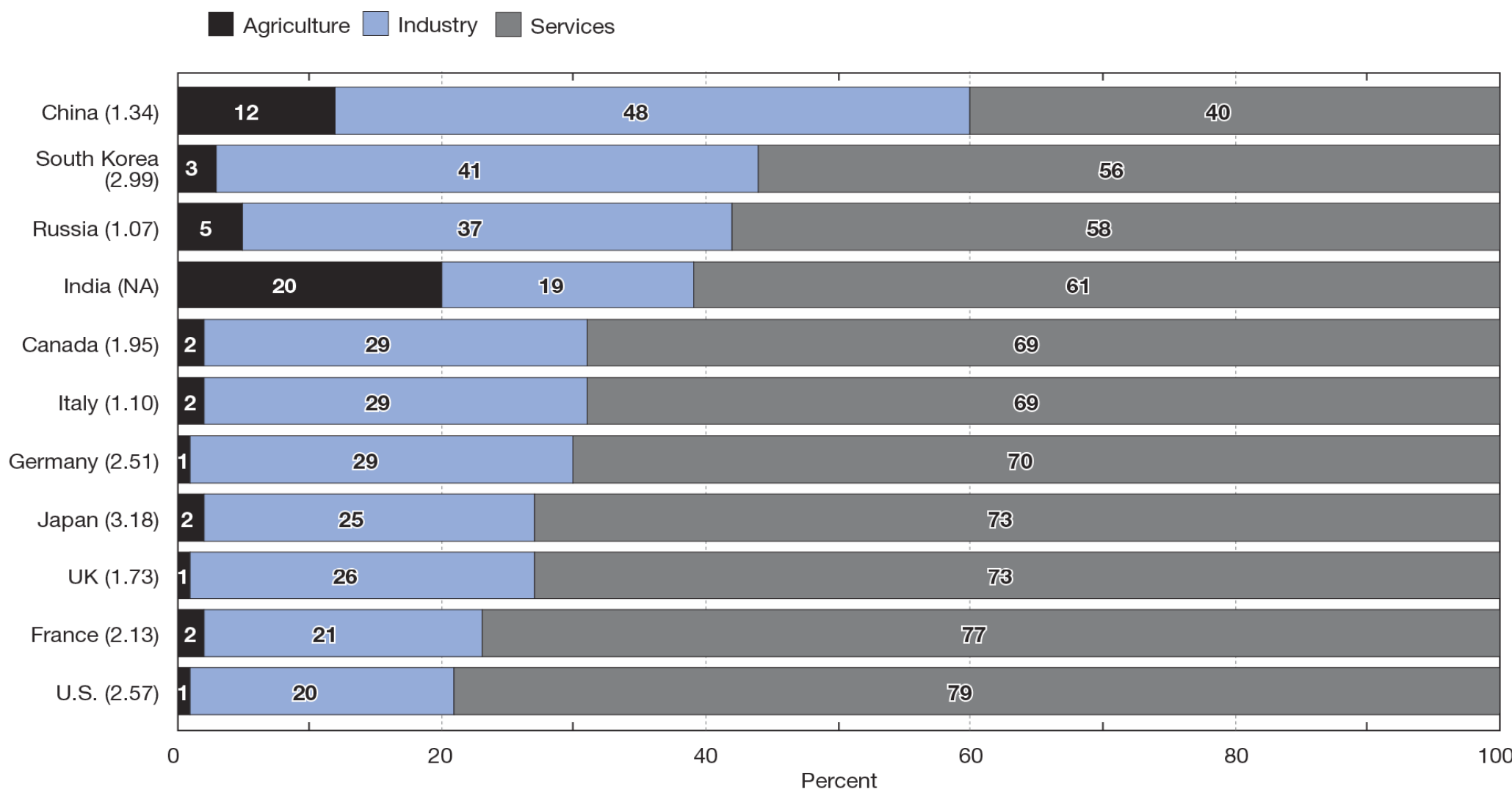
Gross domestic products (GDP) 2008

Source: World Development Indicators database, World Bank

<i>Ranking</i>	<i>Economy</i>	<i>(millions of US dollars)</i>
1	United States	14,204,322
2	Japan	4,909,272
3	China	3,860,039
4	Germany	3,652,824
5	France	2,853,062 ^a
6	United Kingdom	2,645,593
7	Italy	2,293,008
8	Brazil	1,612,539
9	Russian Federation	1,607,816
10	Spain	1,604,174
11	Canada	1,400,091
12	India	1,217,490
13	Mexico	1,085,951
14	Australia	1,015,217
15	Korea, Rep.	929,121
16	Netherlands	860,336
17	Turkey	794,228
18	Poland	526,966
19	Indonesia	514,389
20	Belgium	497,586
21	Switzerland	488,470
22	Sweden	480,021
23	Saudi Arabia	467,601
24	Norway	449,996
25	Austria	416,380



Composition of GDP and R&D/GDP ratio for selected countries, by sector: 2006 or most recent year

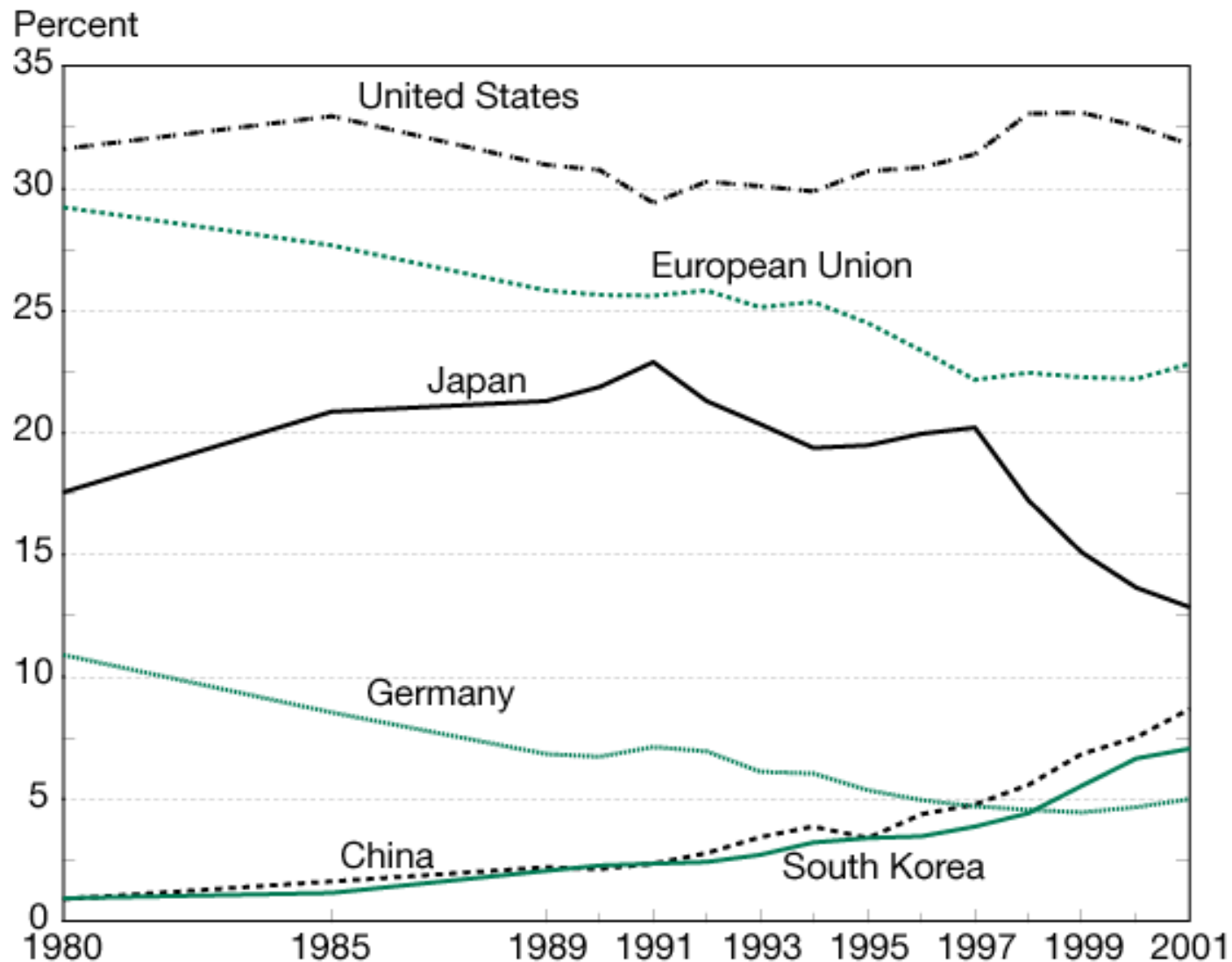


NA = not available

GDP = gross domestic product; UK = United Kingdom

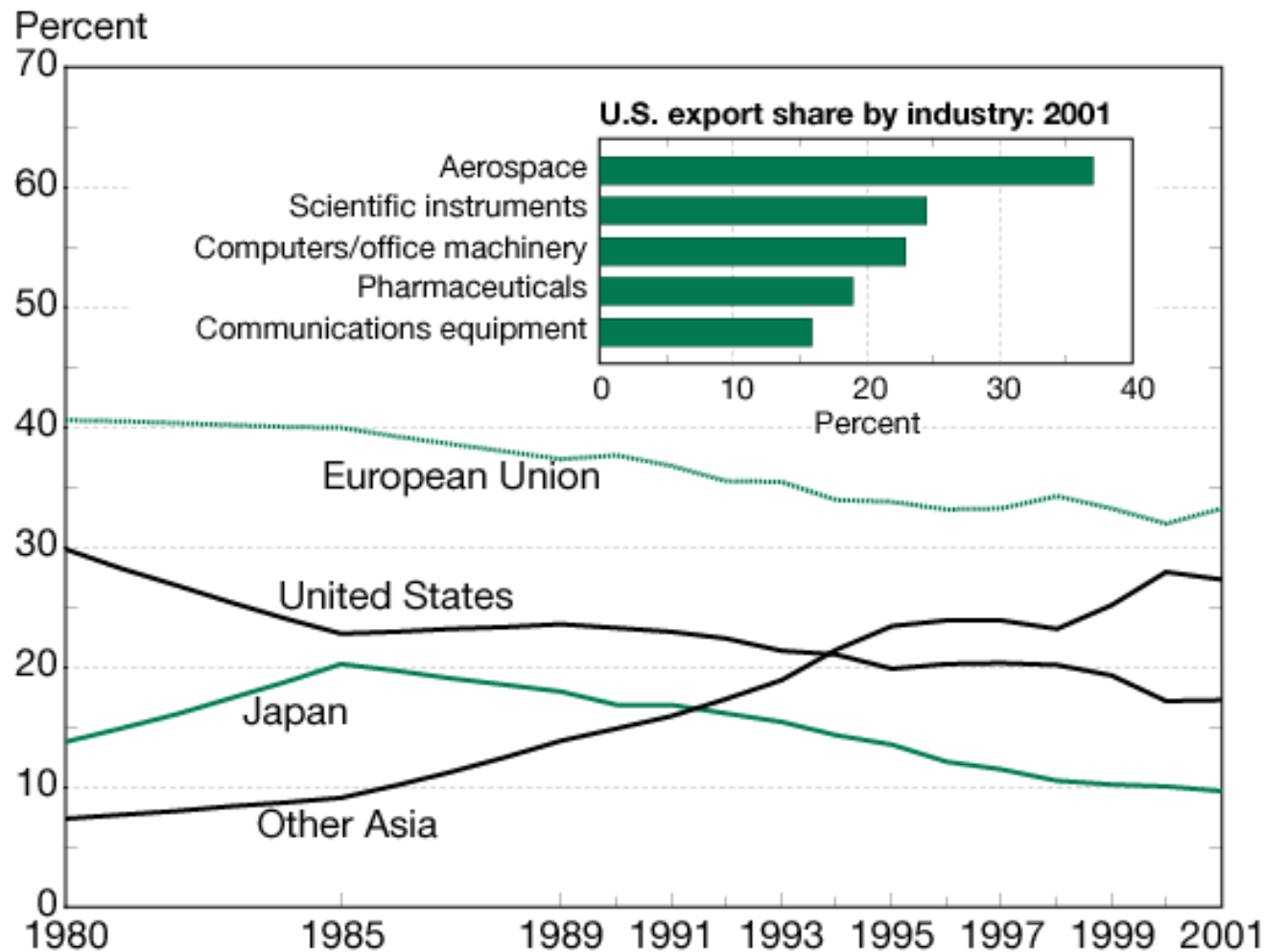
Source: NSF, Science and Engineering Indicators- 2008

Global high-technology market share, by selected country/region: 1980–2001



Source: NSF, Science and Engineering Indicators- 2004

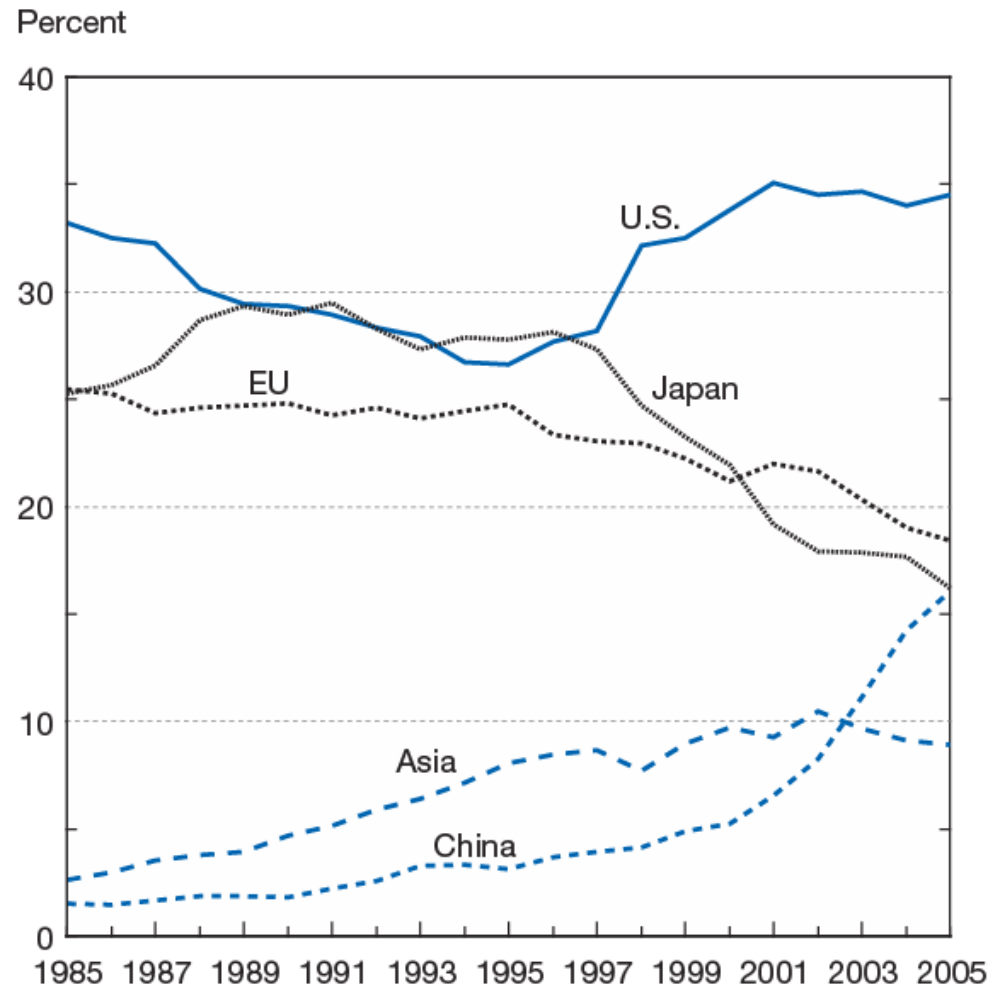
Global high-technology export share, by selected country/region: 1980–2001



NOTES: Other Asia includes China, South Korea, Malaysia, Singapore, and Taiwan. Data for 1981–84 and 1986–88 are extrapolated.

Source: NSF, Science and Engineering Indicators- 2004

World share of high-technology manufacturing, by region/country: 1985–2005

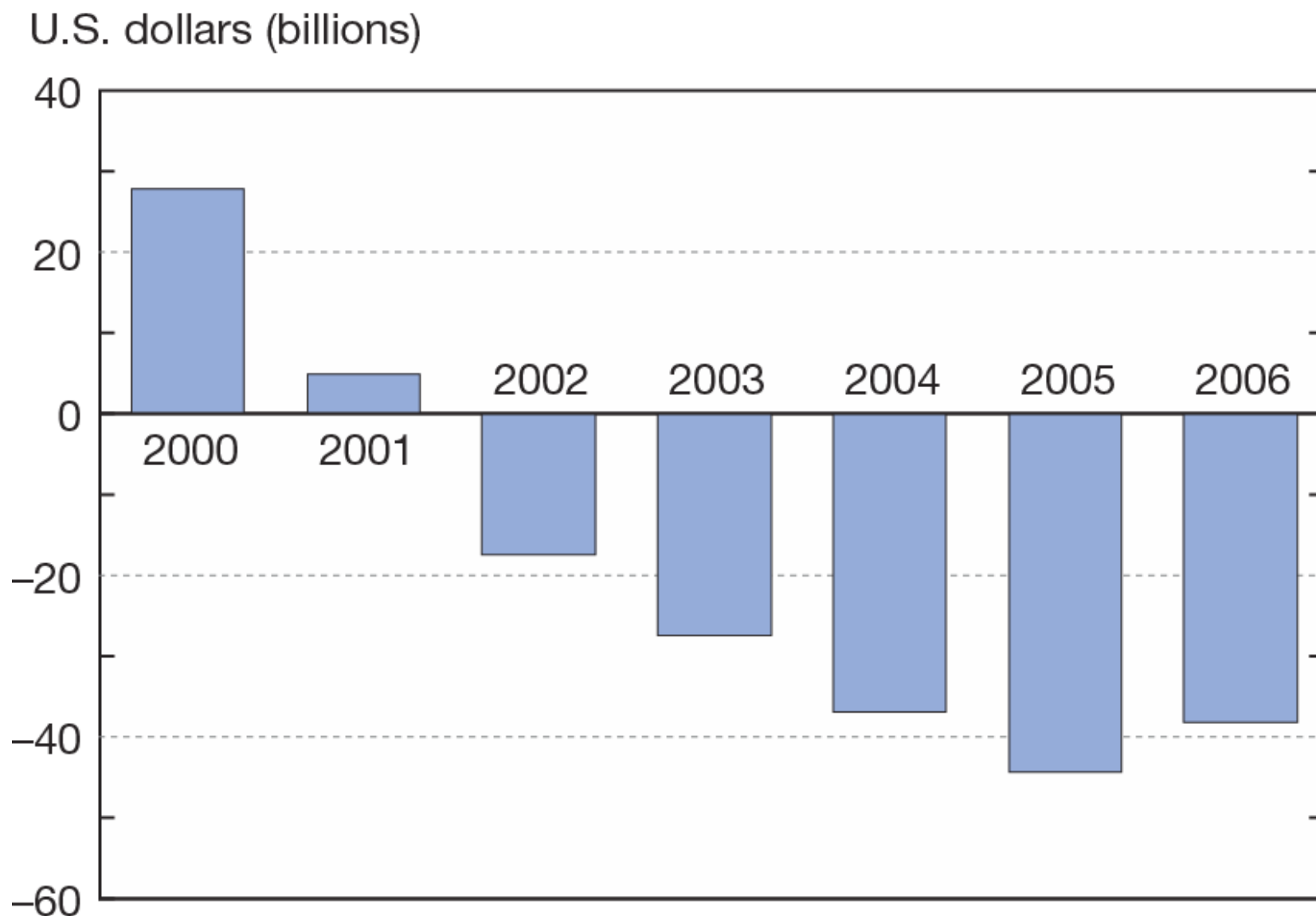


EU = European Union

NOTES: Asia includes India, Indonesia, Malaysia, Philippines, Singapore, South Korea, Taiwan, and Thailand. China includes Hong Kong.

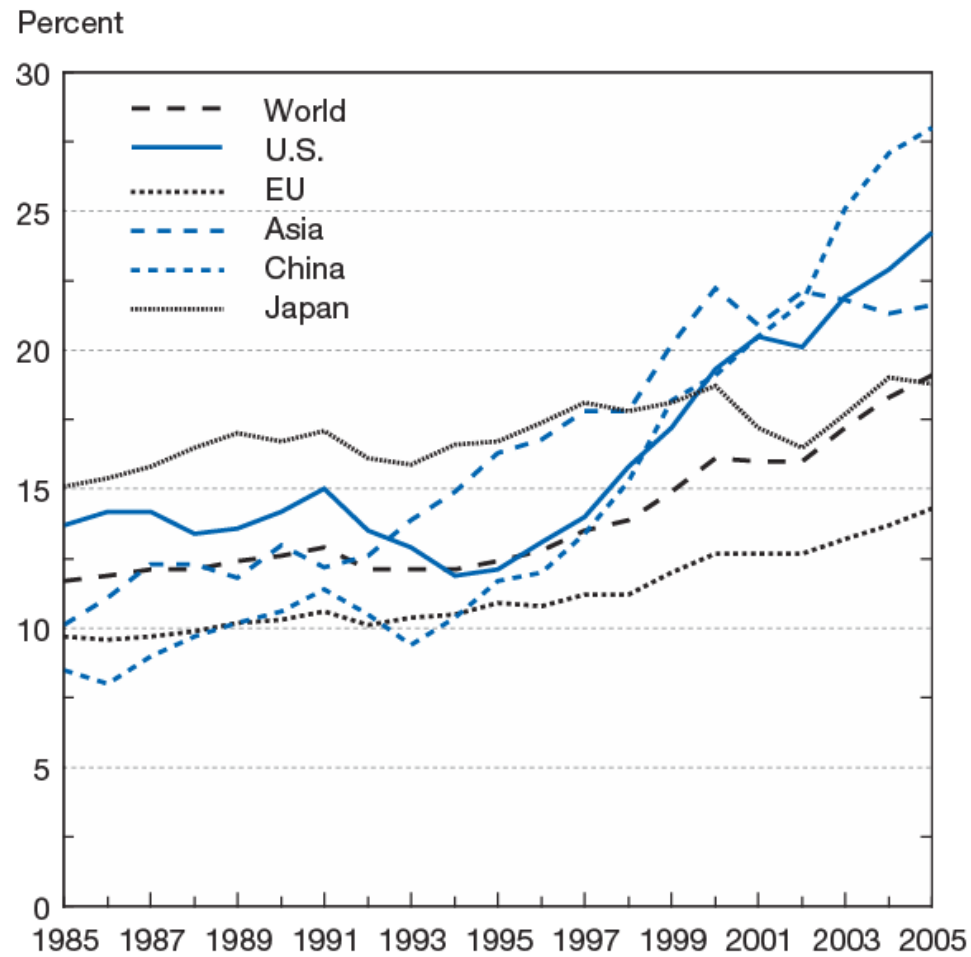
Source: NSF, Science and Engineering Indicators- 2008

U.S. trade balance in high-technology goods: 2000–06



Source: NSF, Science and Engineering Indicators- 2008

High-technology manufacturing share of total manufacturing, by region/country: 1985–2005



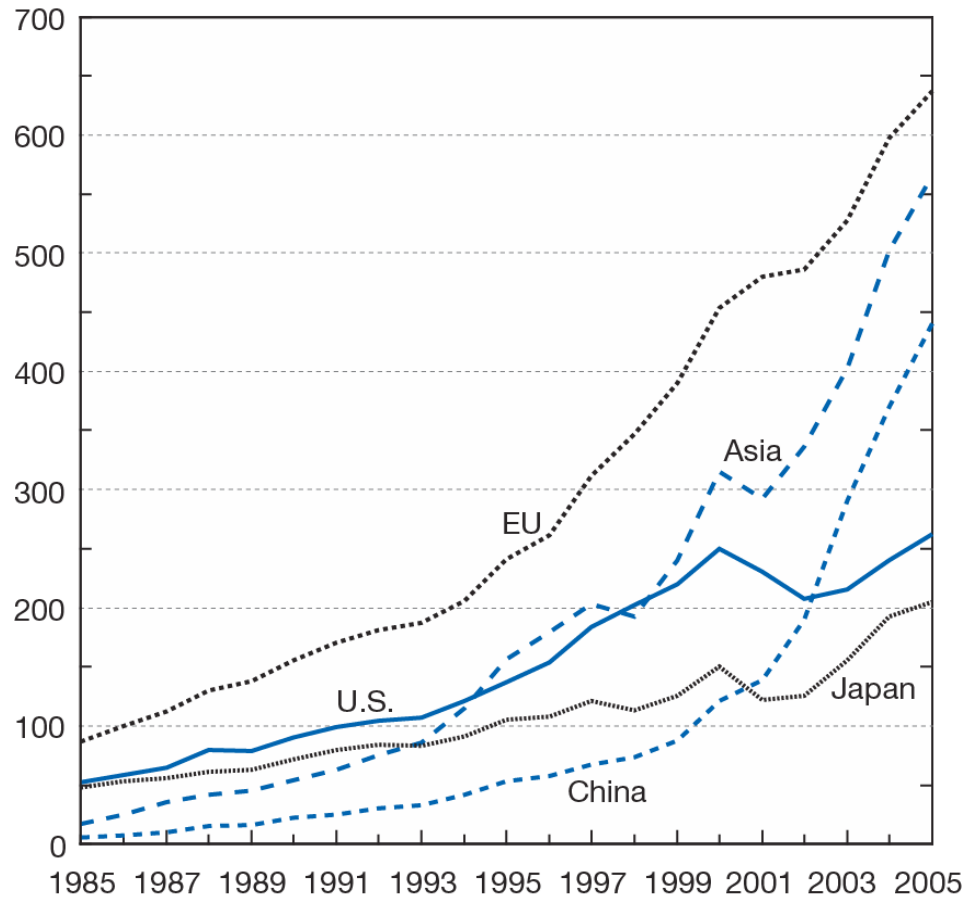
EU = European Union

NOTES: Asia includes India, Indonesia, Malaysia, Philippines, Singapore, South Korea, Taiwan, and Thailand. China includes Hong Kong.

Source: NSF, Science and Engineering Indicators- 2008

Export volume of high-technology manufactures, by region/country: 1985–2005

Constant 2000 dollars (billions)

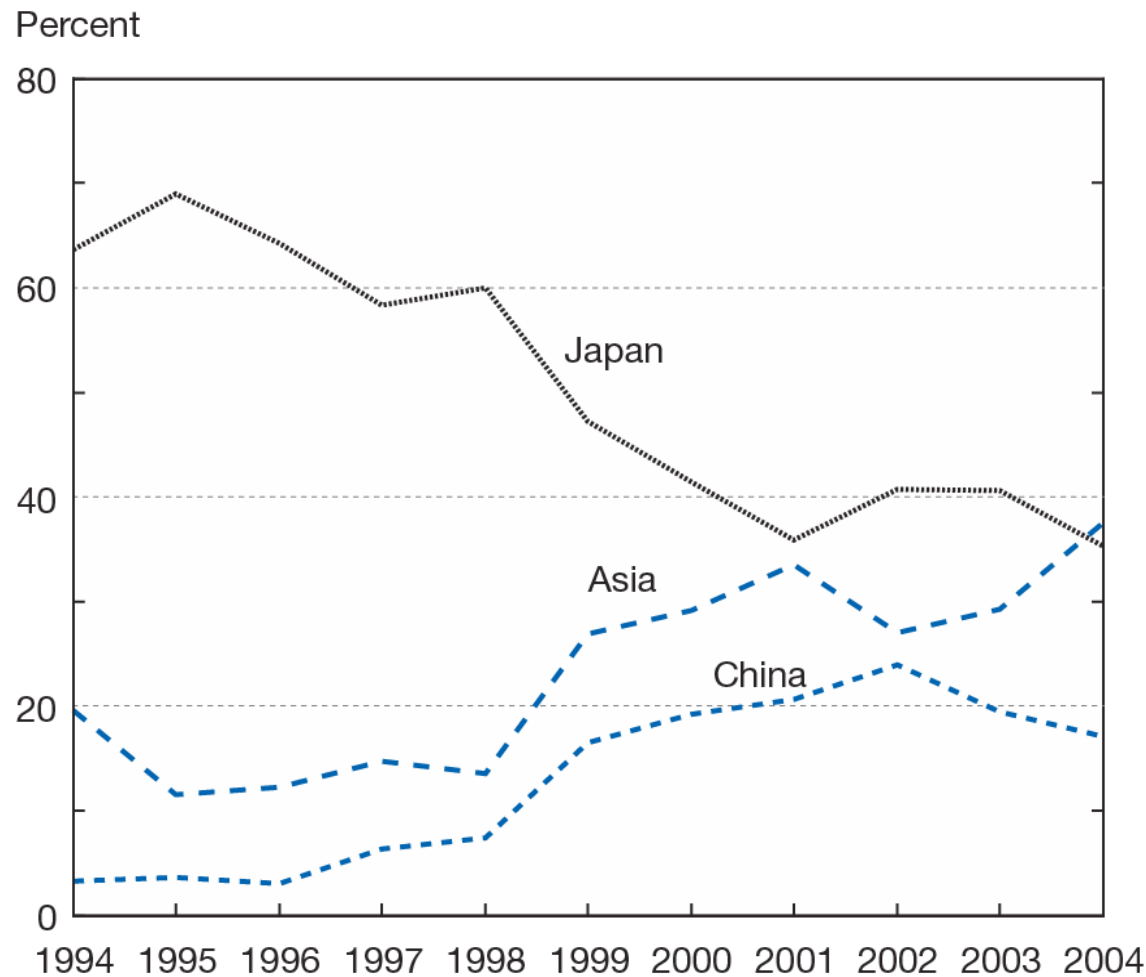


EU = European Union

NOTES: Asia includes India, Indonesia, Malaysia, Philippines, Singapore, South Korea, Taiwan, and Thailand. China includes Hong Kong.

Source: NSF, Science and Engineering Indicators- 2008

R&D performed in Asia by majority-owned affiliates of U.S. parent companies, by region and selected country: 1994–2004



NOTES: Preliminary estimates for 2004. Asia includes India, Indonesia, Malaysia, Philippines, Singapore, South Korea, Taiwan, and Thailand. Data for some intervening years are extrapolated.

Source: NSF, Science and Engineering Indicators- 2008

Free Market Vision

- Zhao Ziyang - China's greatest liberal
- Market-Liberal Vision
 - Strengthening the socialist legal system
 - Advocated new types of institutions to promote development of a market system
- Required political reform
- Viewed as a threat
 - Ousted from General Secretary position
- How would the world look at or deal with China if the Market-Liberal Vision had been fully implemented?

Science and Technology Mission

- To promote and improve innovation
- To strengthen fundamental research and Hi-tech Development
- To guide the transfer of science and technology achievements
- To ensure bilateral international science and technology cooperation and exchange
- To take charge of management of science and technology

How much Innovation has stemmed from China, given its strong S&T Mission?

S & T Policy & Programs

Since	S&T Programs	Implemented through	Goal / Objectives
1982	National Key Technologies R&D Program	Four Five-year Plans	To address pressing major S&T issues in national economic and social development. The program concentrates on the R&D of key and common technologies that drive technical upgrading and restructuring of industries that promote sustainable social development
1986	National High-tech R&D Program (863 Program)	Three Five-year Plans	To boost innovation capacity in the high-tech sectors, particularly in strategic high-tech fields, in order to gain a foothold in the world arena
1997	National Program on Key Basic Research Projects (973 Program)	10th Five-year plan	To build up a solid S&T foundation for the sustainable socio-economic development.
	R&D Infrastructure and Facility Development	10th Five-year plan	To strengthen activities involving basic S&T and public interests and to promote international S&T cooperation along with national S&T bases construction
	Environment Building for S&T Industries	10th Five-year plan	To strengthen policy for environment construction, promote regional economic development, enhance technical services and exchanges, stimulate development of small and medium-sized S&T enterprises (S&T SMEs), vigorously develop S&T intermediaries, and create a sound environment for the commercialization of S&T findings and the their industrialization.
	Mega-projects of Science Research	10th Five-year plan	To take favorable positions in the science frontier in the 21st century and achieve significant technical breakthroughs, leading to industrialization in major fields related to national socio-economic development, all within 3 to 5 years.

Data from Ministry of Science and Technology of the People's Republic of China

<http://www.most.gov.cn> and China Science and Technology Statistics <http://www.sts.org.cn>

Analysis of Research & Development

- Primary R&D focus
 - Manufacturing
 - Electronics
 - Information Technology
- National R&D expenditure trends
- Distribution of R&D expenditures
- Comparisons to leading countries
 - United States
 - Japan
 - Germany
 - South Korea
- Future R&D projections



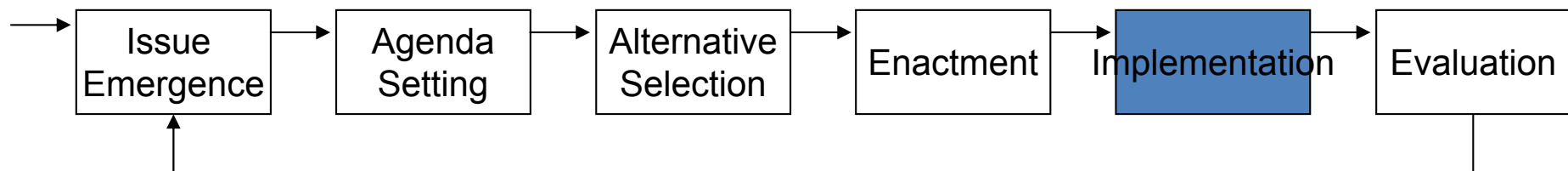
Implementation - Special Economic Zones

Figure 3. China: Special Economic Zones



Coastal areas receive intensive infrastructure and investment

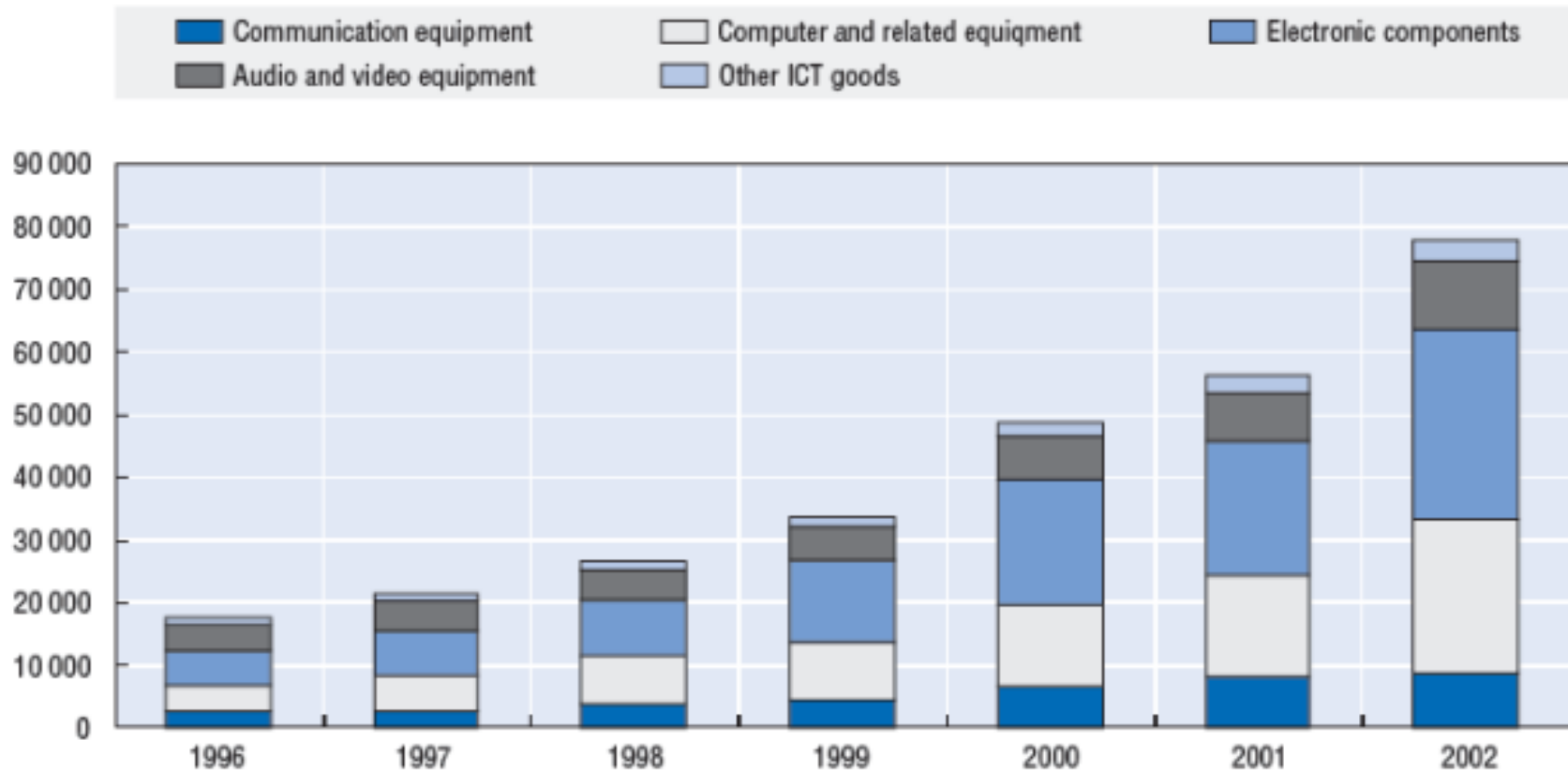
http://en.wikipedia.org/wiki/Special_Economic_Zone



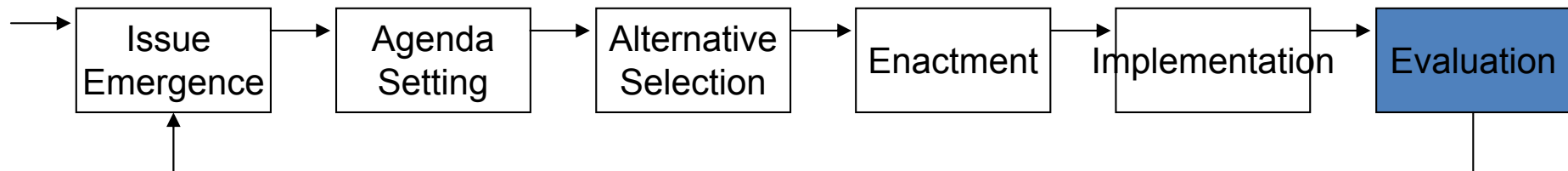
Evaluation – China's Trade in ICT Goods (1996-2002)

Current USD millions

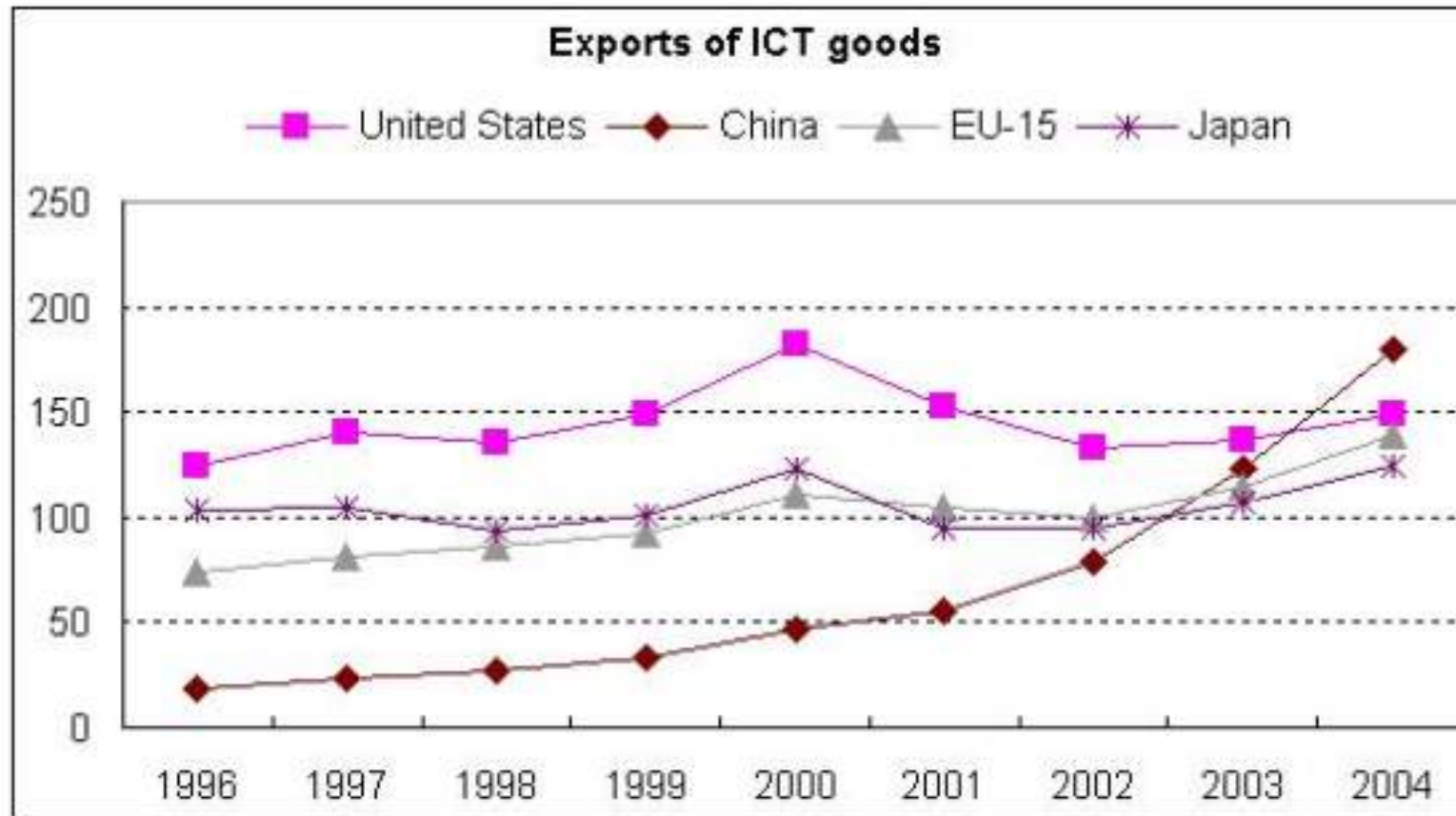
28% CAGR in ICT Exports



Source: OECD ITS database.

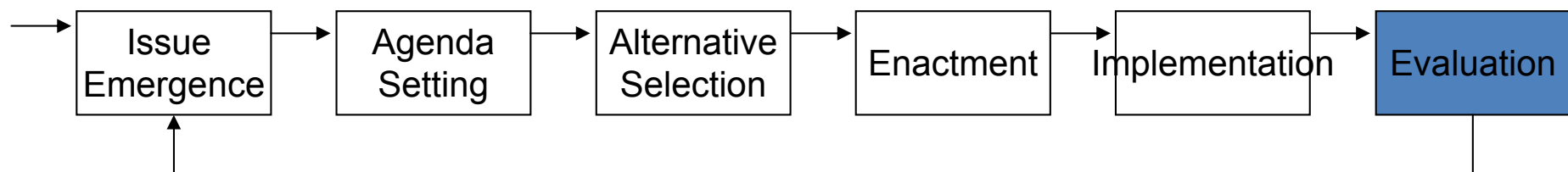


Dominance in Exports of ICT Goods



China is biggest exporter of Information Technology Goods in 2004

OECD: ITS database.



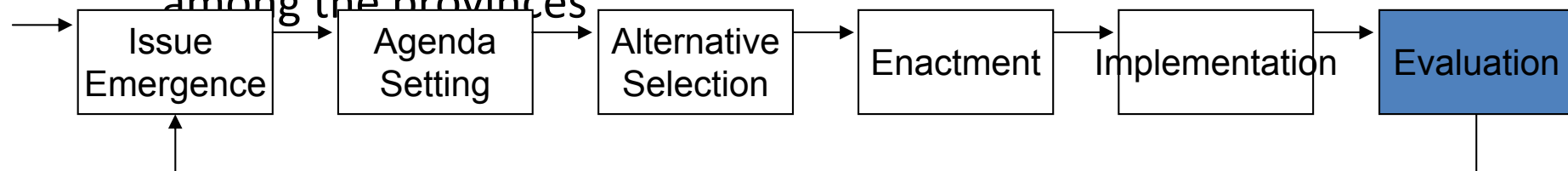
Centralized v. Free Market S&T Policy

- Centralized Pros

- Easier implementation of policies
- Focus on national agenda
- Administrative control
- Centralized wealth pool
- State monitoring and auditing of regions
- Common policies help streamline resources and provide guidance
- Uniform policies guide the nation eliminating dysfunction among the provinces

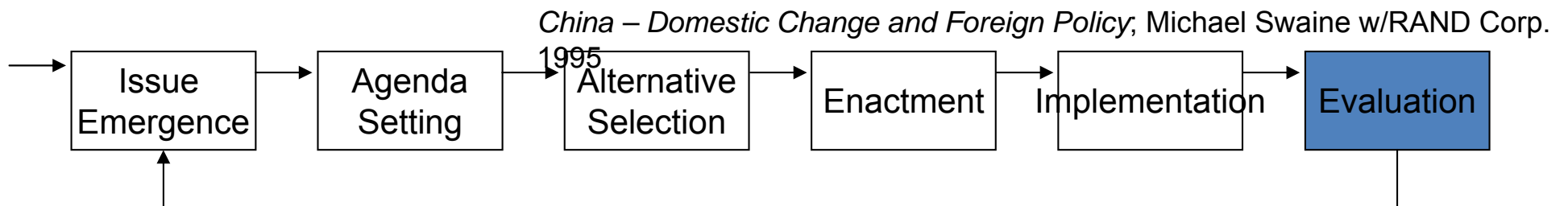
- Free Market Pros

- Diversified goal seeking reveals unique opportunities
- Freedom for the investors
- Many choices for all to participate
- Increased foreign investment
- Liberalizing trade agreements
- Increased consumer choices
- Optimized resource allocations
- Broadens global reach



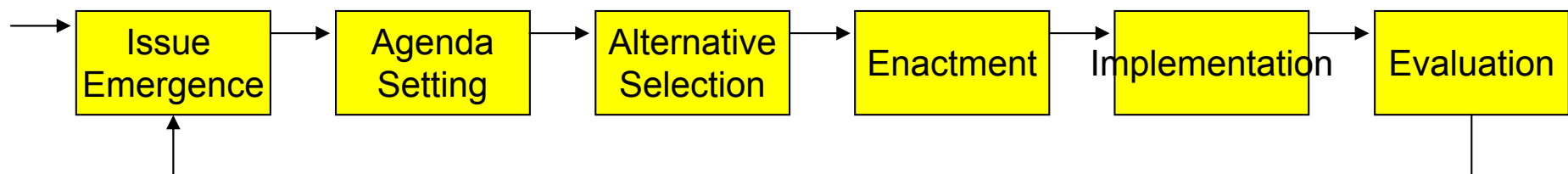
China's Future

- Exploding technology, innovation & commercial opportunity
- Sustained high growth & expanding private sector
- Unique pattern of urbanization:
 - Society in transition or...
 - Social upheaval
- Further decentralization of economic decision-making
- Increased disparities in incomes between the regions
- Possible scenarios:
 - Highly assertive China bent on regional & global dominance
 - Defensive China obsessed with preventing foreign intervention
 - Chaotic and uneven growth spurs domestic unrest & revolution
 - China cooperates with the West and enjoys “Peaceful Rise”



Interim Conclusions

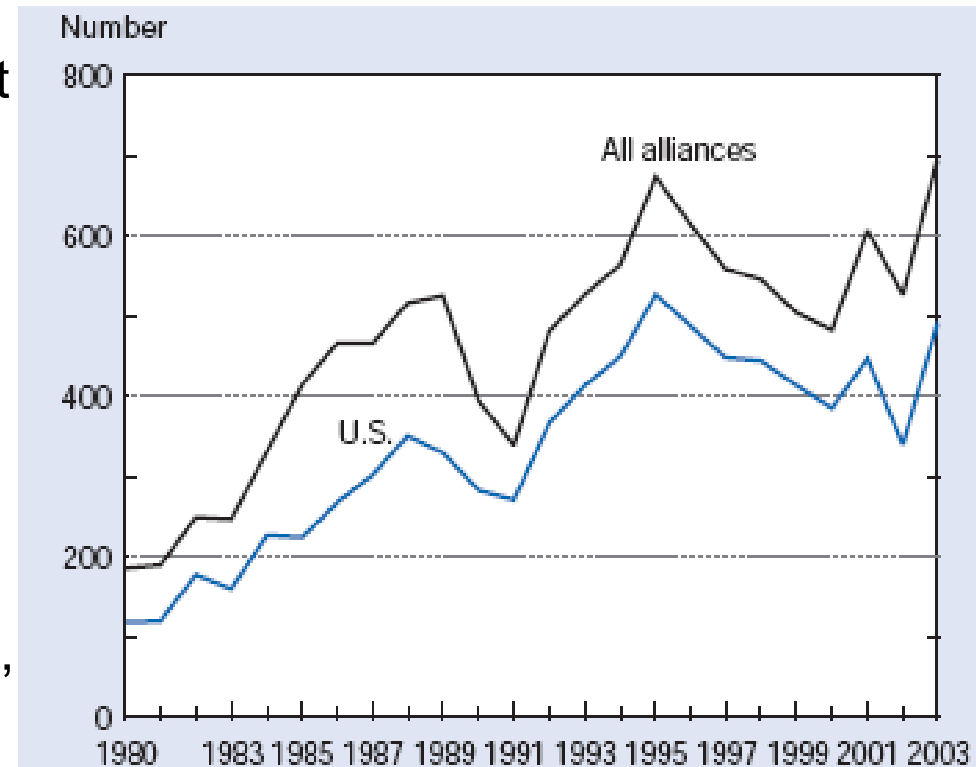
- The Black Box...
 - S&T Policy >> 20% CAGR R&D >> 28% CAGR ICT Trade
- China's 2007 (2005) GDP surpassed \$3.43T (\$1.8T)
- 10% GDP growth rate has been spurred and sustained by centralized S&T Policy.
- Wide discrepancy between East and West will need to be addressed to sustain healthy growth
- Centralized policy around education, resources, and science will require balance with Free Market reform.



Change

Worldwide industrial technology alliances and those with at least one U.S.-owned company: 1980–2003

1. The Cooperative Agreements and Technology Indicators database-Maastricht Economic Research Institute on Innovation and Technology (CATI-MERIT, funded in part by NSF), includes domestic and international technology agreements
2. In 2003 (latest data available) there were 695 new industrial technology alliances Worldwide.
3. These alliances involve mostly companies from the United States, Europe, and Japan, focusing to a large extent on **biotechnology and information technology products**, services, or techniques.
4. Other technology areas include advanced materials, aerospace and defense, automotive, and (non-biotechnology) chemicals.



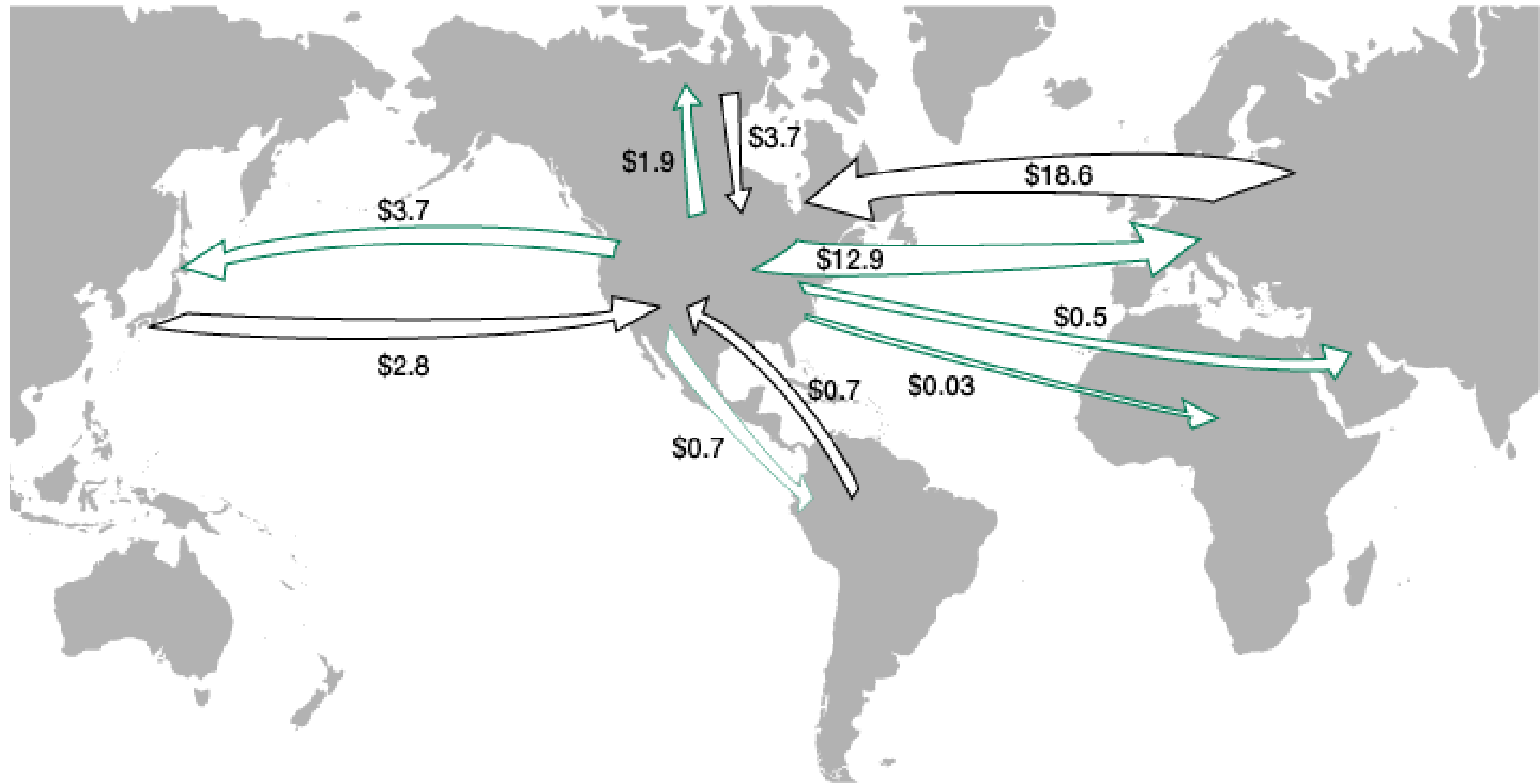
NOTE: Annual counts of new alliances.

SOURCE: Maastricht Economic Research Institute on Innovation and Technology, Cooperative Agreements and Technology Indicators (CATI-MERIT) database, special tabulations.

SOURCE: National Science Board, *Science and Engineering Indicators-20*

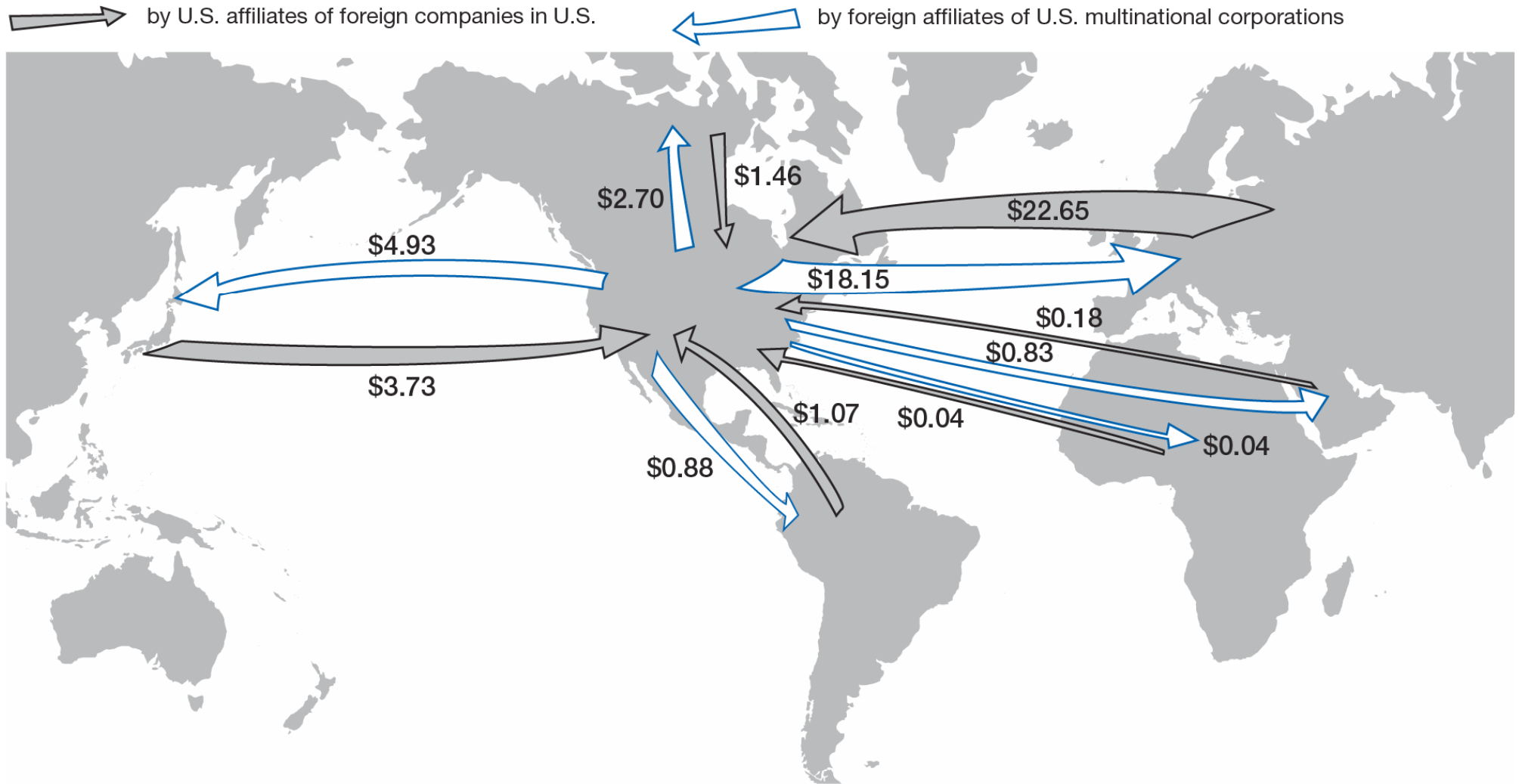
Foreign-owned R&D in United States and U.S.-owned R&D overseas, by investing/host region

(Billions of current U.S. dollars)



SOURCE: National Science Board, Science and Engineering Indicators-200

Foreign-owned R&D in United States and U.S.-owned R&D overseas, by investing/host region: 2004 or later



Current U.S. dollars (billions)

NOTES: Preliminary estimates for 2004. 2002 data for U.S. affiliates of foreign companies from Latin America and Middle East.

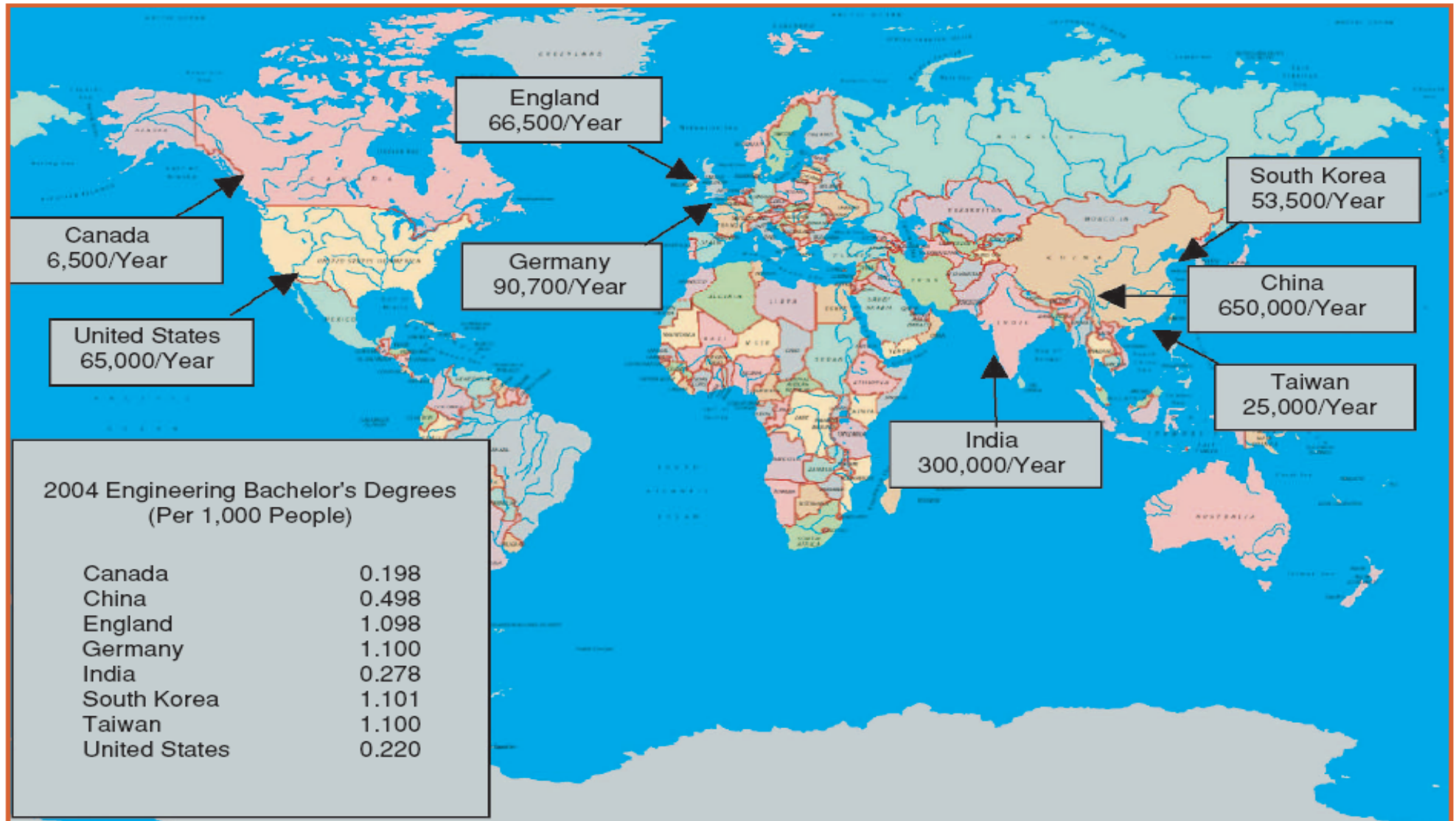
Source: NSF, Science and Engineering Indicators- 2008

Example: China

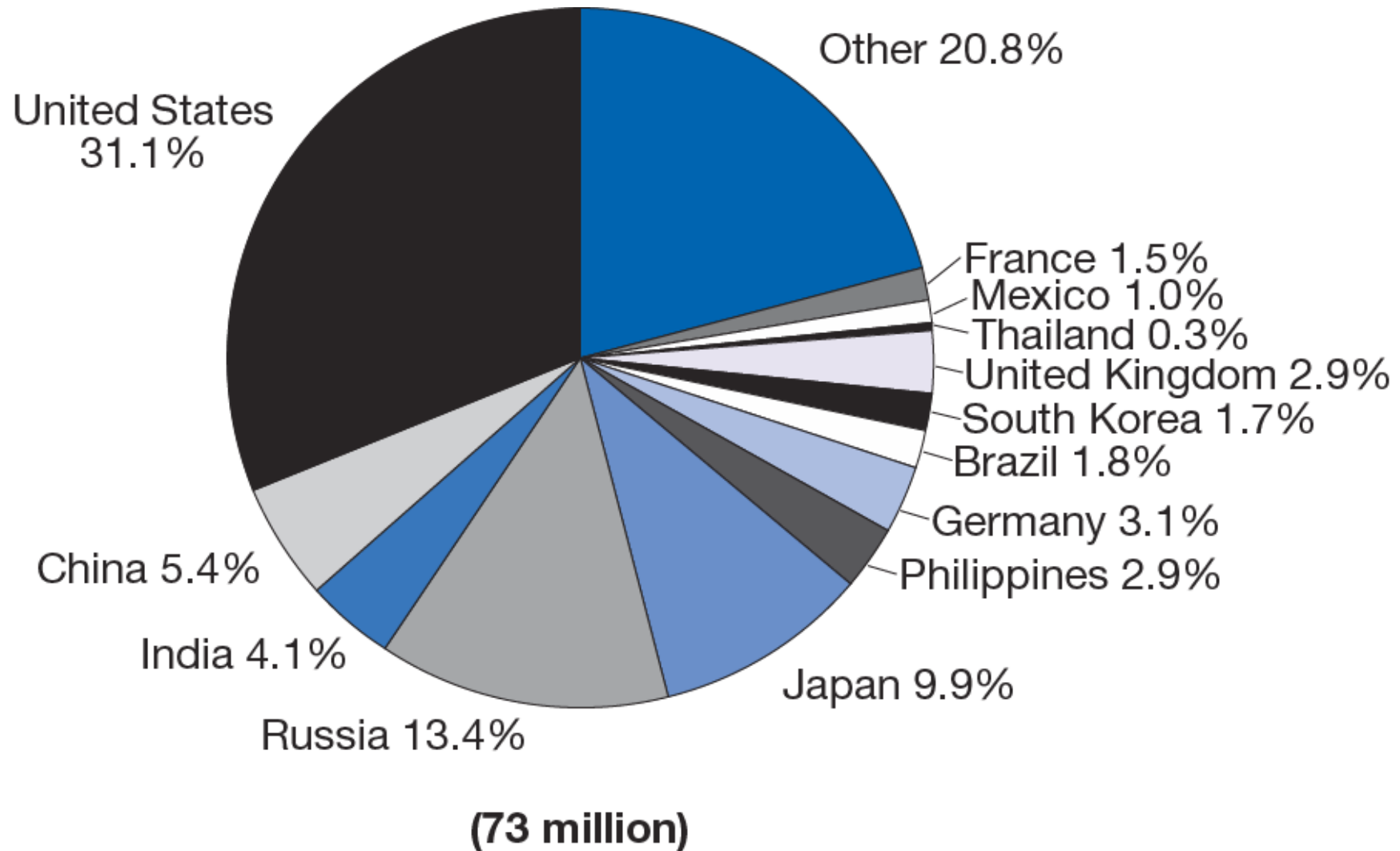


- Chinese universities graduate 700,000 new engineers per year (according to recent assessments only about 10%, this percentage is rapidly increasing, are engineers and the remaining are technicians)

Engineering bachelor's degrees by country

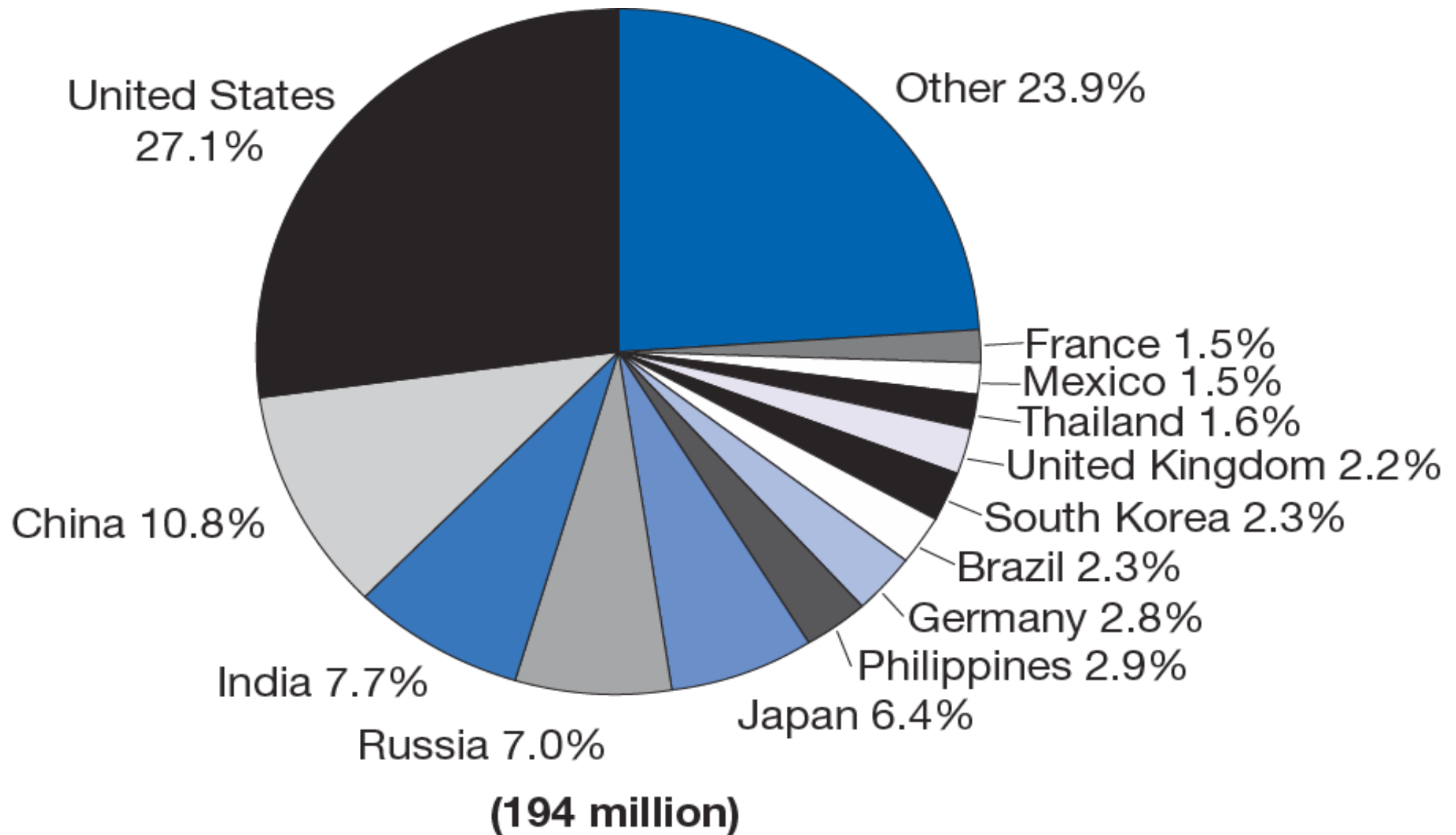


Population 15 years old or older with tertiary education, by country/region: 1980



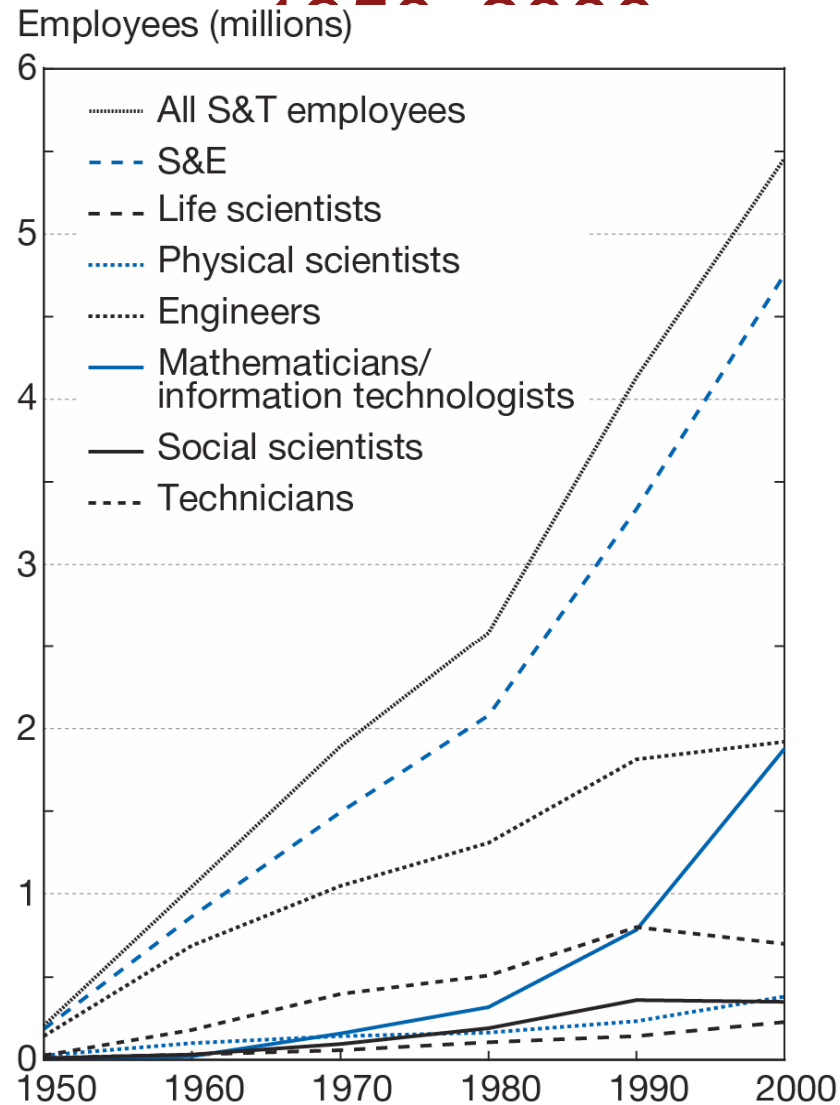
Source: NSF, Science and Engineering Indicators- 2008

Population 15 years old or older with tertiary education, by country/region: 2000



Source: NSF, Science and Engineering Indicators- 2008

Science and technology employment:

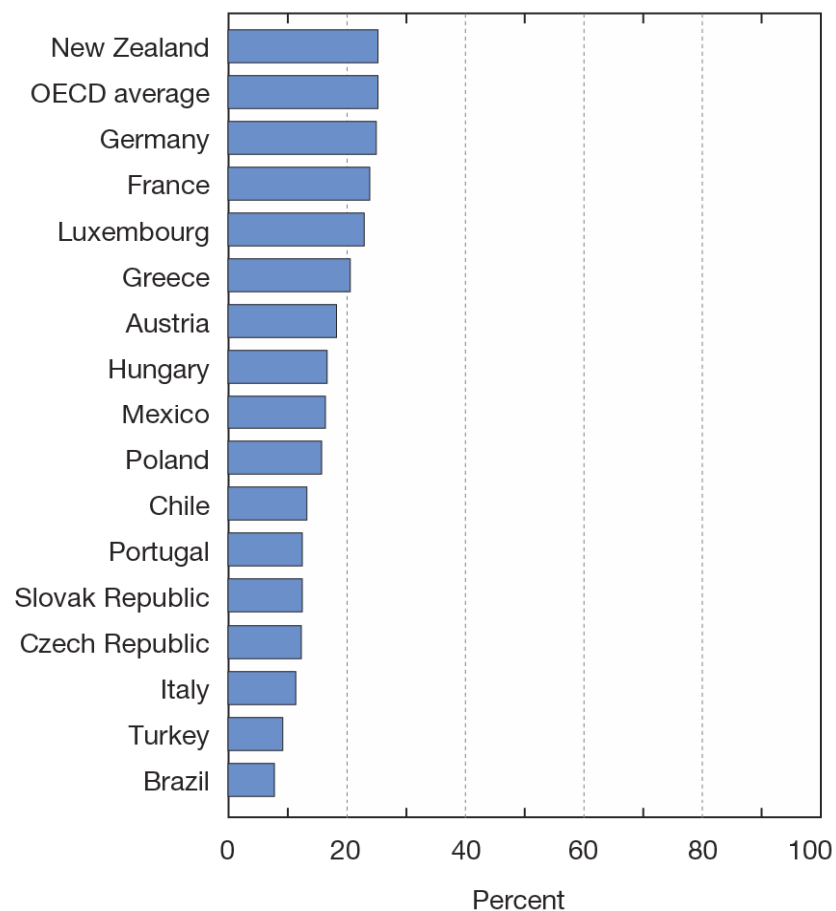
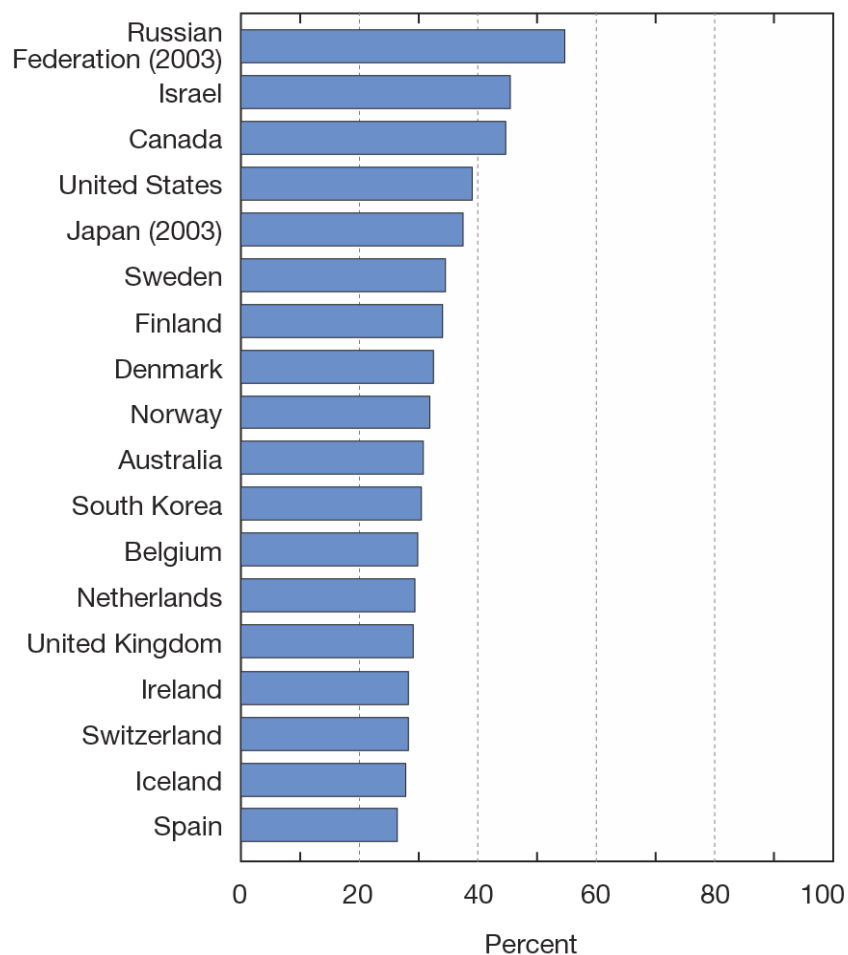


S&T = science and technology

NOTE: Data include bachelor's degrees or higher in science occupations, some college and above in engineering occupations, and any education level for technicians and computer programmers.

Source: NSF, Science and Engineering Indicators- 2008

Total tertiary degree attainment by 25–64-year-olds, by country: 2004

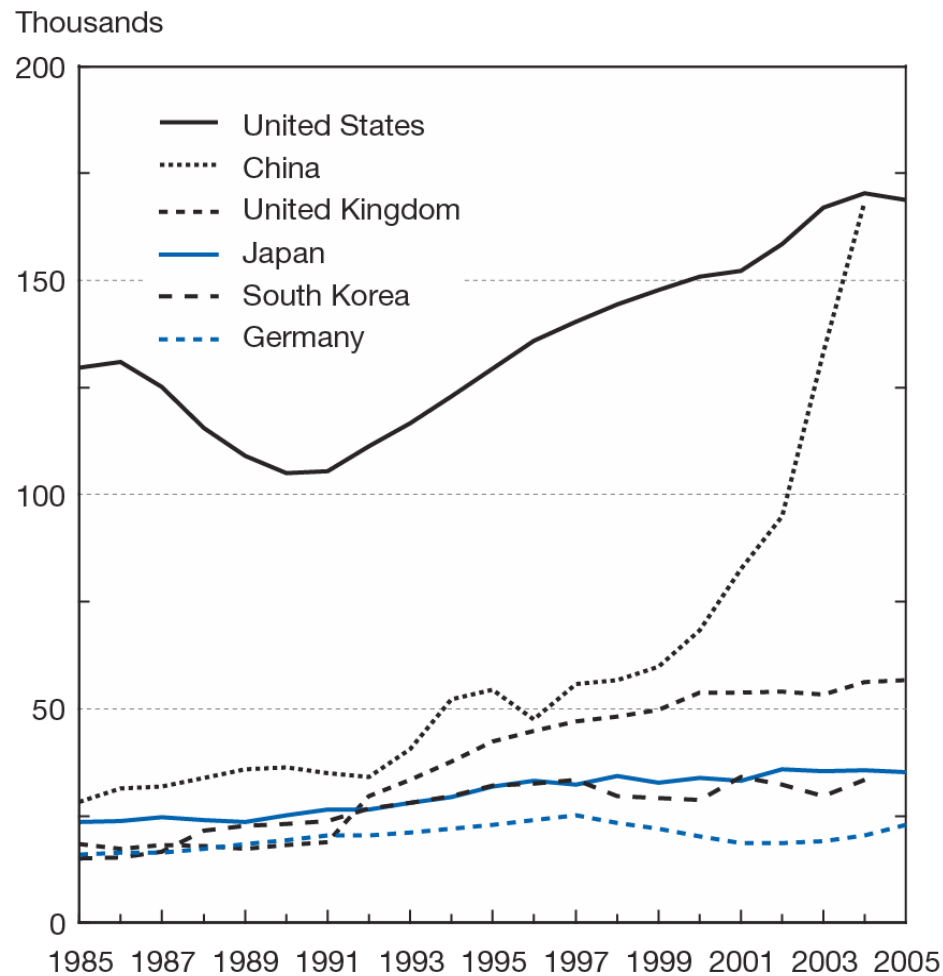


OECD = Organisation for Economic Co-operation and Development

NOTES: Tertiary education includes International Standard Classification of Education (ISCED) levels 5A, 5B, and 6 programs. ISCED 5A programs largely theory-based and designed to provide sufficient qualifications for entry into advanced research programs and professions with high skill requirements. ISCED 5B programs focus on practical, technical, or occupational skills for direct entry into labor market. ISCED 6 programs devoted to advanced studies and original research leading to award of an advanced research qualification. In United States, ISCED 5B corresponds to associate's, ISCED 5A corresponds to bachelor's and master's, and ISCED 6 corresponds to doctoral degrees.

Source: NSF, Science and Engineering Indicators- 2008

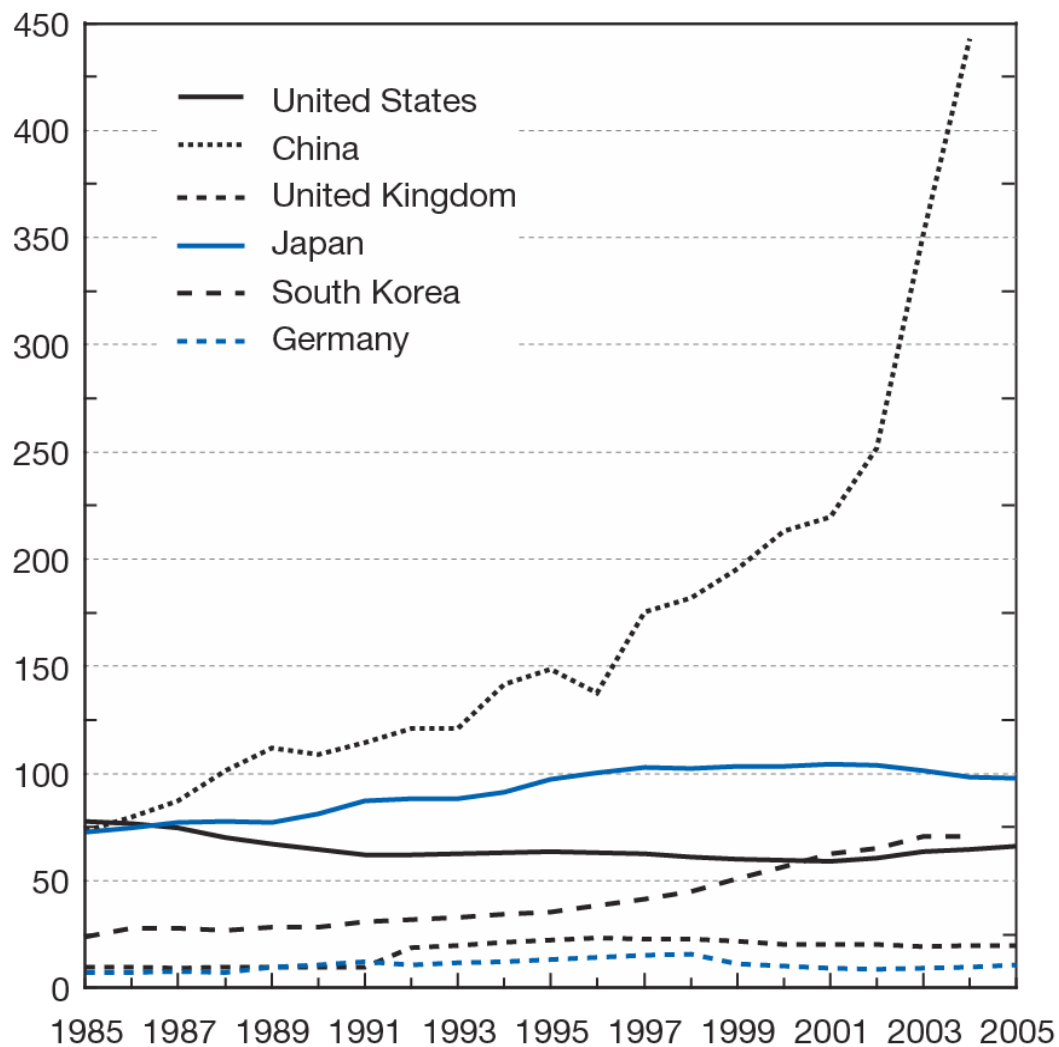
First university natural sciences degrees, by selected country: 1985–2005



NOTES: Natural sciences include physical, biological, earth, atmospheric, ocean, agricultural, and computer sciences and mathematics. German degrees include only long university degrees required for further study.

Source: NSF, Science and Engineering Indicators- 2008

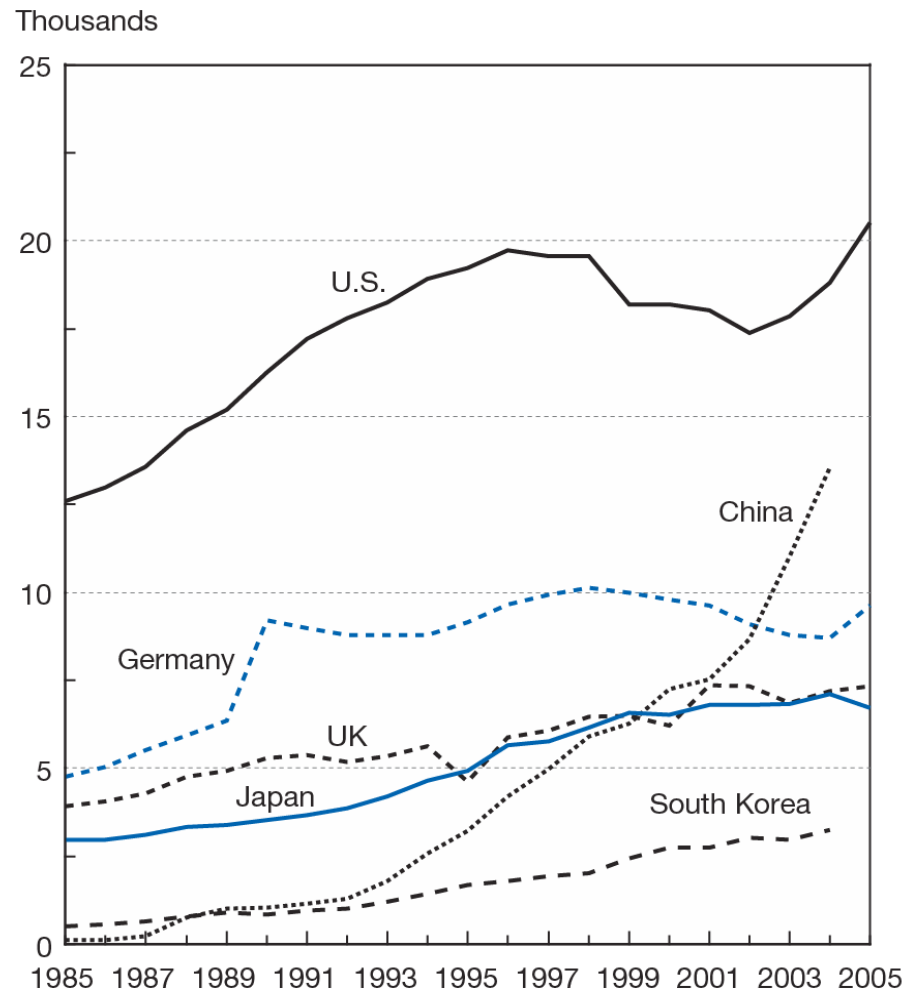
First university engineering degrees, by selected country: 1985–2005



NOTES: German degrees include only long university degrees required for further study.

Source: NSF, Science and Engineering Indicators- 2008

Natural sciences and engineering doctoral degrees, by selected country: 1985–2005

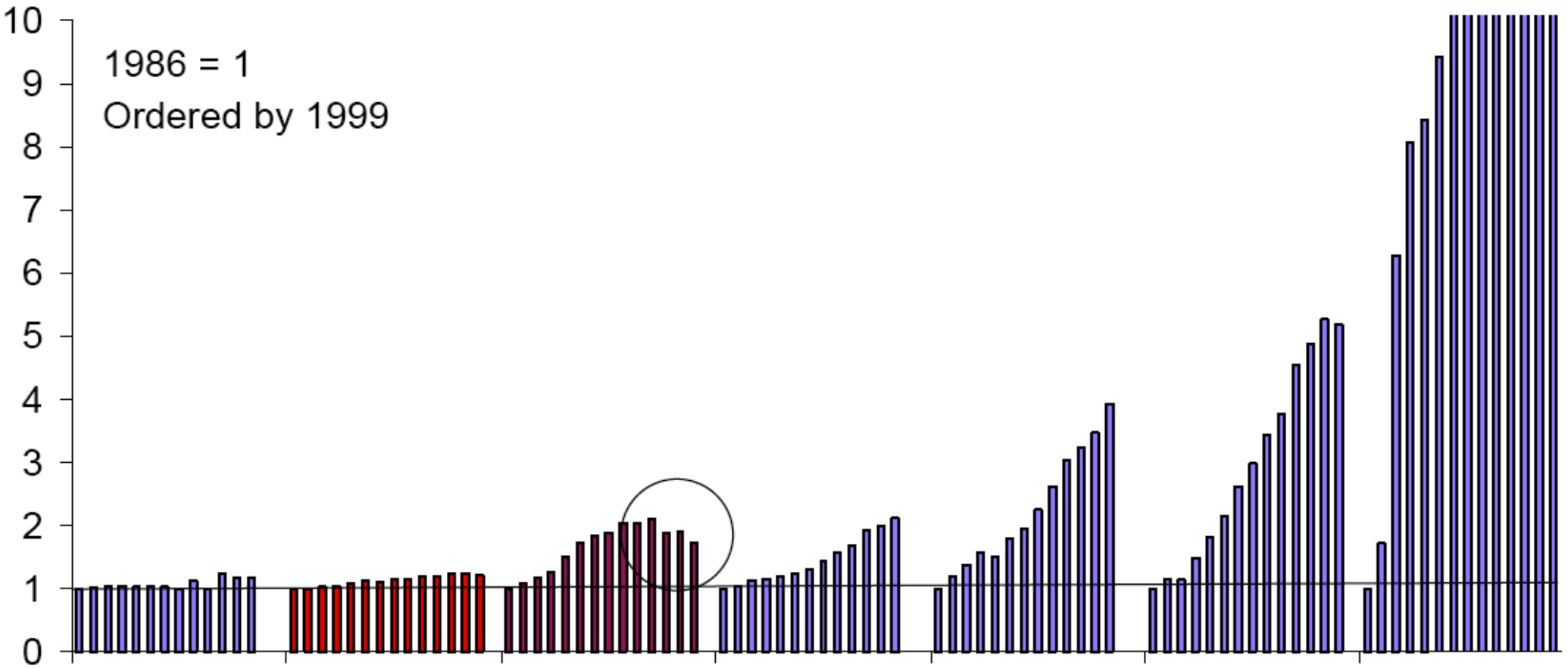


UK = United Kingdom

NOTE: Natural sciences and engineering include physical, biological, earth, atmospheric, ocean, agricultural, and computer sciences; mathematics; and engineering.

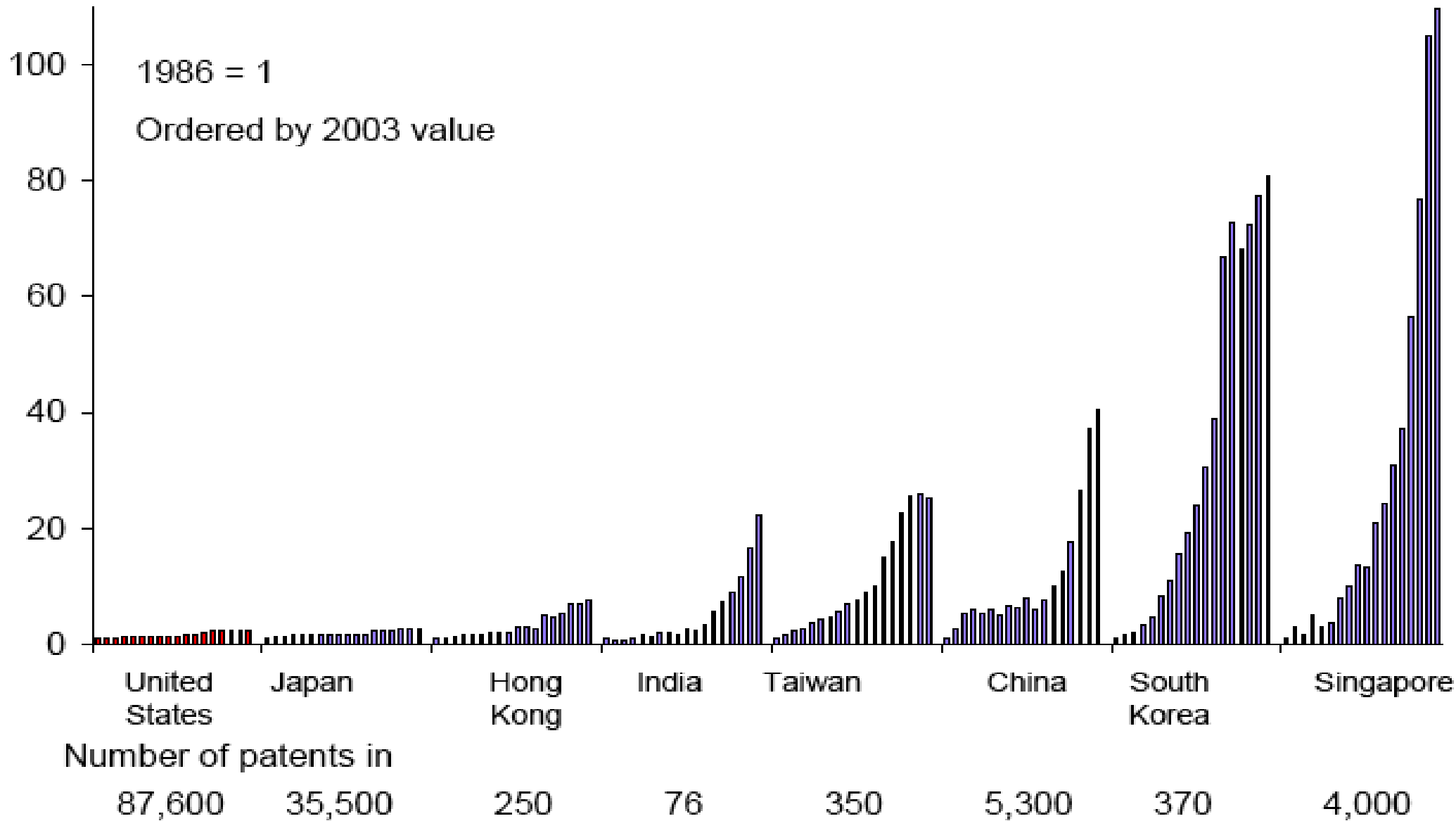
Source: NSF, Science and Engineering Indicators- 2008

Growth in doctoral degrees awarded 1986-1999



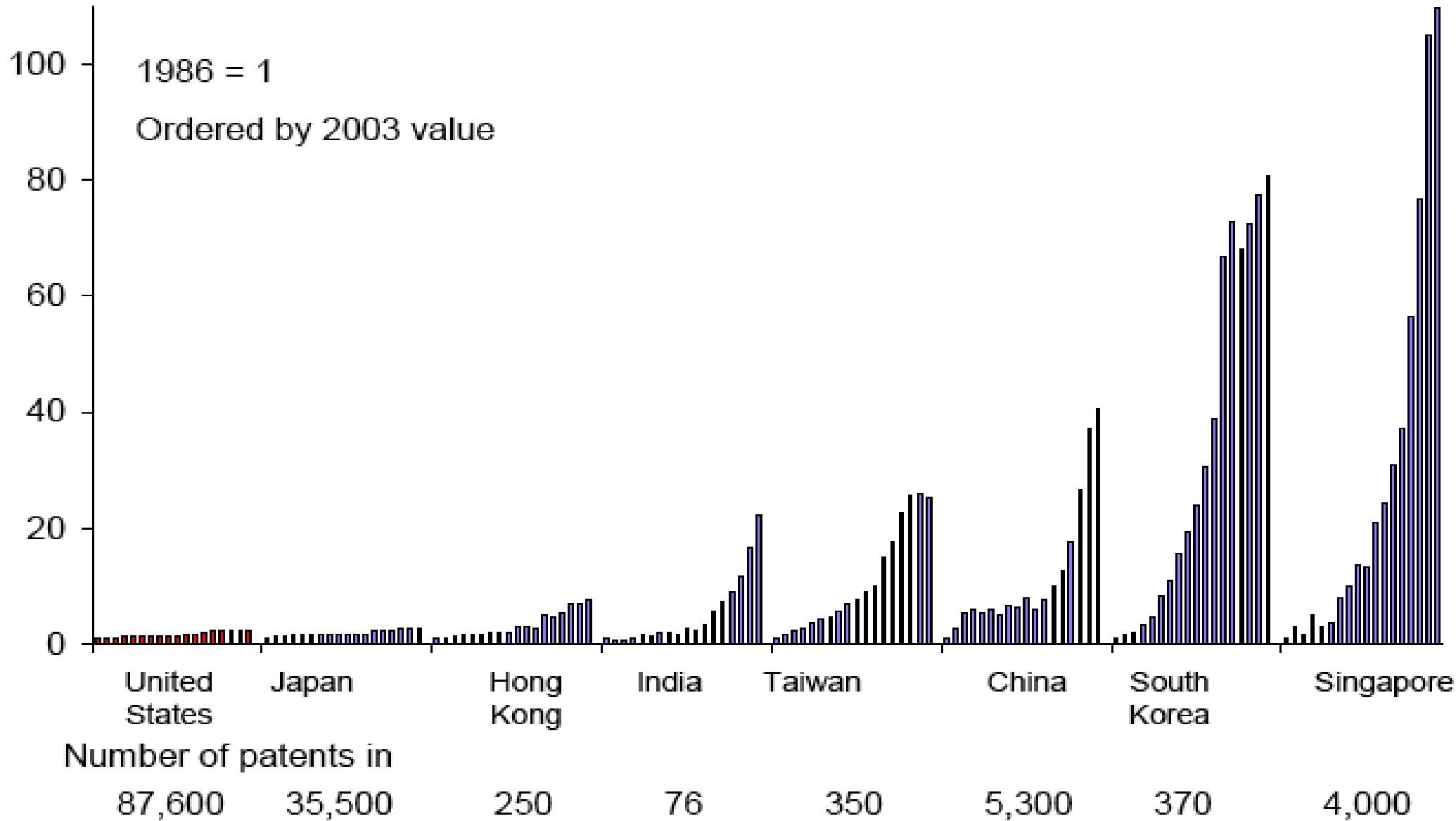
Country/Category	Number of degrees awarded in 1998
India	4,800
US - citizens	16,200
US - non-citizens	9,800
Japan	6,600
South Korea	2,500
Taiwan	900
China	6,400

Growth in U.S patents invented in Asia – 1986-2003



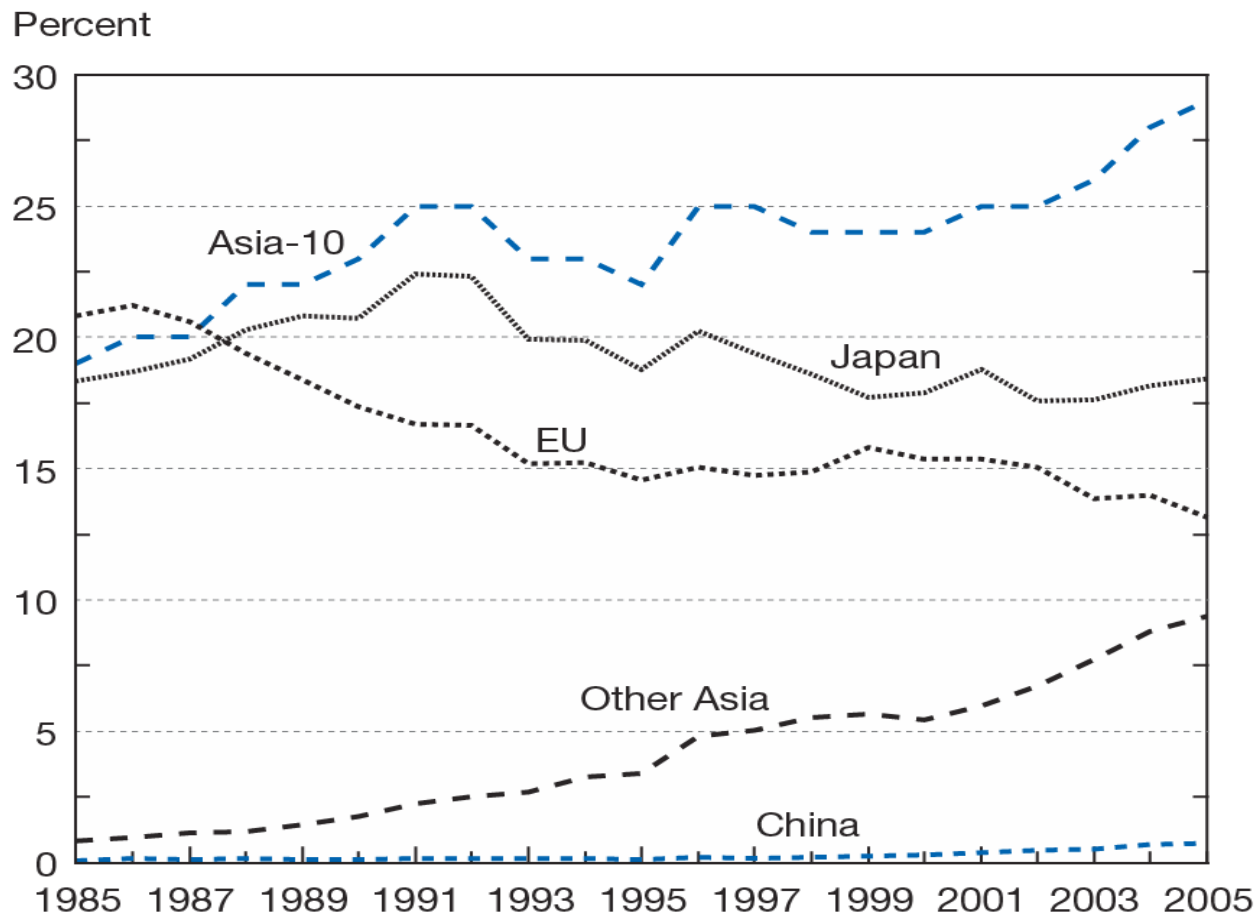
Source: CHI Research, Inc. International Patent Indicators, 2004,

Growth in U.S patents invented in Asia – 1986-2003



Source: CHI Research, Inc. International Patent Indicators, 2004,

Proportion of total USPTO patent applications from Asia and EU: 1985–2005

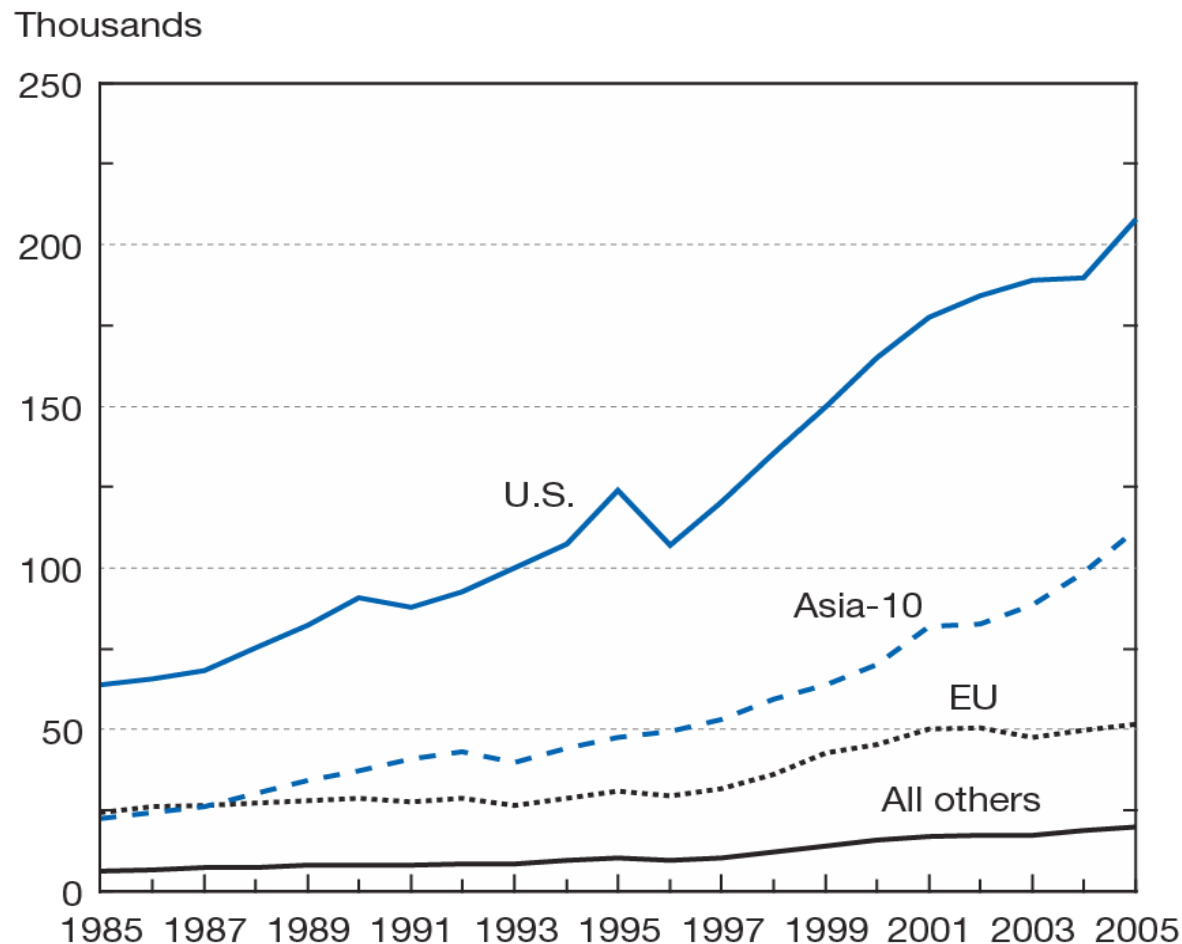


EU = European Union; USPTO = U.S. Patent and Trademark Office

NOTES: Country of origin based on residence of first-named inventor. Asia-10 includes China, India, Indonesia, Japan, Malaysia, Philippines, Singapore, South Korea, Taiwan, and Thailand. China includes Hong Kong.

Source: NSF, Science and Engineering Indicators- 2008

USPTO patent applications, by region/country: 1985–2005



EU = European Union; USPTO = U.S. Patent and Trademark Office

NOTES: Country of origin based on residence of first-named inventor. Asia-10 includes China, India, Indonesia, Japan, Malaysia, Philippines, Singapore, South Korea, Taiwan, and Thailand. China includes Hong Kong.

Source: NSF, Science and Engineering Indicators- 2008

Issues with IP in China(問題)

- Copyright Piracy – \$2.5 - \$3.8 Billion per year
- Cultural issues - “Impossible to separate the inventor’s activity from the society of which the inventor is part”
- Judges lack of experience in dealing with IP issues
- Struggling with balance between economic development and protection of IP rights
- Law implementation needs improvement.
- Foreign pressure – primarily from governments. Only 5% from foreign companies.
- 95% of product piracy cases involve violations against Chinese companies.

http://www.bizasia.com/intellectual_property_/b38fc/toyota_pursues_intellectual.htm

<https://asiamedia.ucla.edu/article.asp?parentid=34148>

<https://www.signosandiego.com/news/world/20060310-0049-china-productpiracy.html>

Specific Examples of IP issues in China

- Software Piracy is unauthorized copying, distributing or downloading of copyrighted software.
- Patent Infringement encroachment upon the domain belonging to a patentee that is described by the claims of her/his patent
- Patent Trolling involves finding and procuring patents, then suing infringers of those patents. Can also be used to look at “unpatented” patents from other countries and establishing them in China or Korea.

What Is Software Piracy? (什麼是軟體盜版?)

Three of the most common forms of software piracy are:

- End-user copying: Organizations installing or using software on more computers than they are licensed to support.
- Distribution: Selling or distributing illegally copied software, including counterfeit products.
- Downloading: Making unauthorized copies from the Internet.

Piracy Examples (秘密)

Counterfeit or Authentic?



Which is which?

Piracy Examples (是一部巨大电影)

Counterfeit software:
Shot of Microsoft Office 2000 inside jewel case



Software Piracy: Statistics and Facts

(軟體盜版: 統計和事實)

- More than one third of adult Internet users say they have downloaded commercial software online without paying for all the copies they made. *(Source: "Quantifying Online Downloading of Unlicensed Software – Survey of Internet Users," IPSOS Public Affairs, May 2002)*
- 25% of users who download software say they never pay for it. *(Source: IPSOS, May 2002)*
- Last year, piracy cost the software industry an estimated \$11 billion. *(Source: "2009 Global Software Piracy Report," International Planning and Research Corp., June 2002)*
- The loss to the economy has significant impact, including more than 111,000 jobs lost, \$5.6 billion in lost wages and more than \$1.5 billion in lost tax revenue. *(Source: "2001 State Software Piracy Study," International Planning and Research Corp., October 2002)*

IP Loss Costs for Software

Asia / Pacific	Loss Costs	Western Europe	Loss Costs	North America	Loss Costs
China	\$1.1 Billion	United Kingdom	\$1.2 Billion	North America & Canada	\$10.5 Billion
Japan	\$1.7 Billion	Germany	\$1.1 Billion		
India	\$376 Million	France	\$964 Million		

Patent Infringement Examples (違反例子)

- General Motors vs. Chery
 - Design, Unfair Competition and Trade Secrets
- Toyota vs. Geely Group
 - Copied logo and deceived customers by claiming its cars used Toyota engines
- Starbucks vs. Xingbake
 - Copied it's logo and used it Chinese language name

<http://www.dega.dk/ref.aspx?id=803>



GM Spark



<http://www.dega.dk/ref.aspx?id=803>

Not yet settled...

Chery QQ



<http://www.dega.dk/ref.aspx?id=803>

Toyota loses it's infringement claim against Geely

Toyota



Geely



<http://www.dega.dk/ref.aspx?id=803>

Starbucks Wins....(\$50,000)



<http://readbetweentheps.blogspot.com/2006/01/starbucks-vs-xingbake-ipr-protection.html>

Patent Costs

Country	Patent Cost
China	\$3000-5000
Germany	\$14,361
USA	\$14,370
Japan	\$30,498

Source: <http://www.technology.gov/Reports/JapanPatent/pages.pdf>

Source: http://www.goodwinprocter.com/publications/frank_s_yearpatent_1_03.pdf



Patent Trolling

- Unprotected patents are fodder for counterfeiters, competitors and pirates from countries with low IP protections.
- A Great Wall of Patents – filing for patents in China for copied products.
- Japan currently experiencing 17,000 hits per day from China and 50,000 per day from Korea on their patent website
- Issues for U.S. Patents
 - Patent Pendecy taking up to 30 months
 - 18 month rule is handing over IP to China
 - Backlog of over 500,000 patent apps
 - Counterfeiters are directly using US patent information to file their own patents in China.

<http://www.eetuk.com/bus/news/showArticle.jhtml?articleID=183701296>



US Patent and Trademark Office (USPTO) Role

- USPTO

- Initiated STOP initiative which is a program to stop international piracy and counterfeiting and protect US small and medium sized enterprises overseas.
- Provide toolkits for businesses with IP issues in China, Korea, Mexico, Taiwan and Russia.
- Created China Road show in FY2005 for businesses contemplating entering the China market. Topics included Chinese laws and regulations regarding IP.
- Increased technical assistance in China including training on IP judicial infringement interpretation, criminal copyright infringements, and IP enforcement in Southern China

http://www.uspto.gov/web/offices/com/annual/2005/040204_intel_policy.html

Patent Reform Act of 2005

- Introduced to the House June 8, 2005
- Bill addresses:
 - Patent Quality
 - Limitation of litigation abuses
 - Harmonization of US patent laws with our key trading partners
 - Proposes shift from first-to-invent to first-inventor-to-file
 - Broadens scope of prior user
 - Limitation on treble damages for patent infringement
 - Publication of all patent applications after 18 months
- Changes continue to original bill as it moves through Congress

http://www.uspto.gov/web/offices/com/annual/2005/040204_intel_policy.html



Laws and Treaties (法律和條約)

- Chinese Laws
 - Intellectual property rights can be traced back to Tang Dynasty (618-907 AD)
 - First patent-specific law enacted in 1889
 - Modern patent law began in 1950
 - Cultural Revolution in mid-1960's brought an end to the recognition of intellectual property
 - Adopted trademark laws in 1982
 - Adopted patent laws in 1985
 - “First to File” model
 - Adopted copyright laws in 1986 through 1990
- International Organizations / Treaties / Conventions
 - Became a member of the World Intellectual Property Organization (WIPO) in 1980
 - Became a party to the Madrid Agreement for the International Registration of Trademarks in 1989
 - US is still not a party to the agreement
 - Became a party to Berne Convention for the Protection of Literary and Artistic Works in 1992
 - Became a member of WIPO's Patent Cooperation Treaty in 1994

<http://beijing.usembassy.gov/iprpatent.html>

<http://www.chanlaw.com/ipinchina.htm>



Enforcement (執行)

- Three potential courses of actions for rights holders
- Administrative Adjudication
 - Local officials decide if infringement occurred
 - Quick, but no money to rights holders and very small fines
 - Most popular course of action
- Civil Litigation
 - Civil courts decide if infringement occurred
 - Costly and low damages
 - Increasing in popularity
- Criminal Prosecution
 - Government decides whether or not to prosecute and if infringement occurred
 - Complaints include referral criteria too vague, process permits too much discretion, and minimum evidentiary threshold too high
 - Small percentage of all actions taken

Litigation Awards (享受類?)

- A \$25,000 infringement award does not mean much to a US company but is a significant fine for the Chinese when compared with average annual income

Equivalent Value of a \$25,000 Infringement Award

	Average Annual Household Income	Infringement Award
China	\$ 793	\$ 1,336,492
China (Urban)	\$ 1,307	\$ 811,007
China (Rural)	\$ 406	\$ 2,614,407
United States	\$ 42,409	\$ 25,000

Source: http://www.stats.gov.cn/english/newsandcomingevents/t20060302_402308116.htm

Source: <http://www.census.gov/prod/2003pubs/p60-221.pdf>

Source: http://www.fenwick.com/docstore/publications/Corporate/IP_Strategy_&_Practices.pdf

Risk Assessment Example

(風險評估例子)

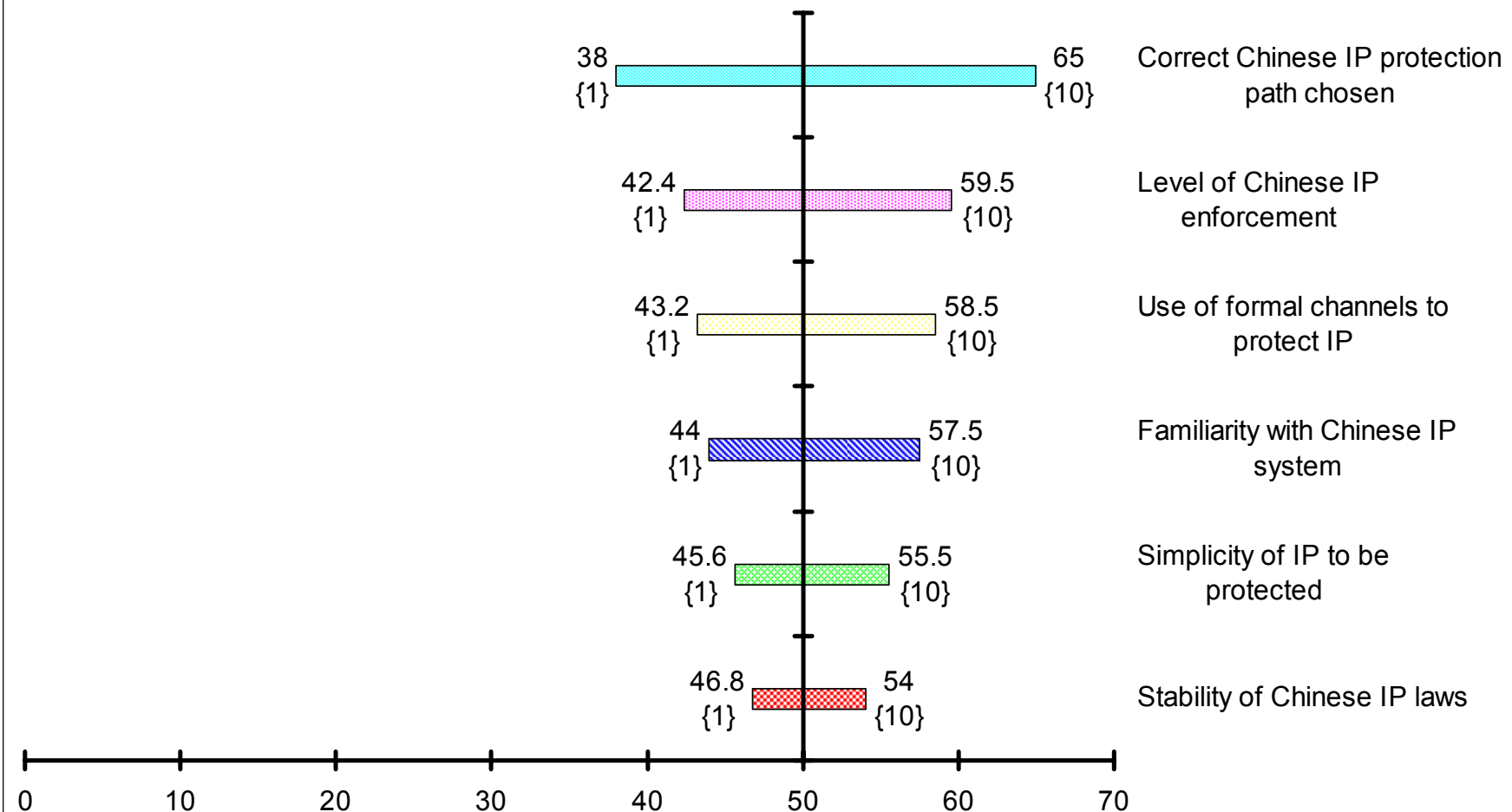
Project Characteristic Question	Rating	Weight	Score
Correct Chinese IP protection path chosen	8	3.0	24.0
Level of Chinese IP enforcement	6	1.9	11.4
Use of formal channels to protect IP	8	1.7	13.6
Familiarity with Chinese IP system	4	1.5	6.0
Simplicity of IP to be protected	5	1.1	5.5
Stability of Chinese IP laws	5	0.8	4.0
	Overall Score		64.5

Overall Score	Risk Level
10-28	Highest
29-46	Higher
47-64	Moderate
65-82	Lower
83-100	Lowest

<http://home.cinci.rr.com/estople/omrat/omrat.htm>

Risk Assessment Sensitivity Analysis (几乎完成)

**Tornado Diagram
(Single Factor Sensitivity Analysis)**



<http://www.tushar-mehta.com/excel/software/tornado/>

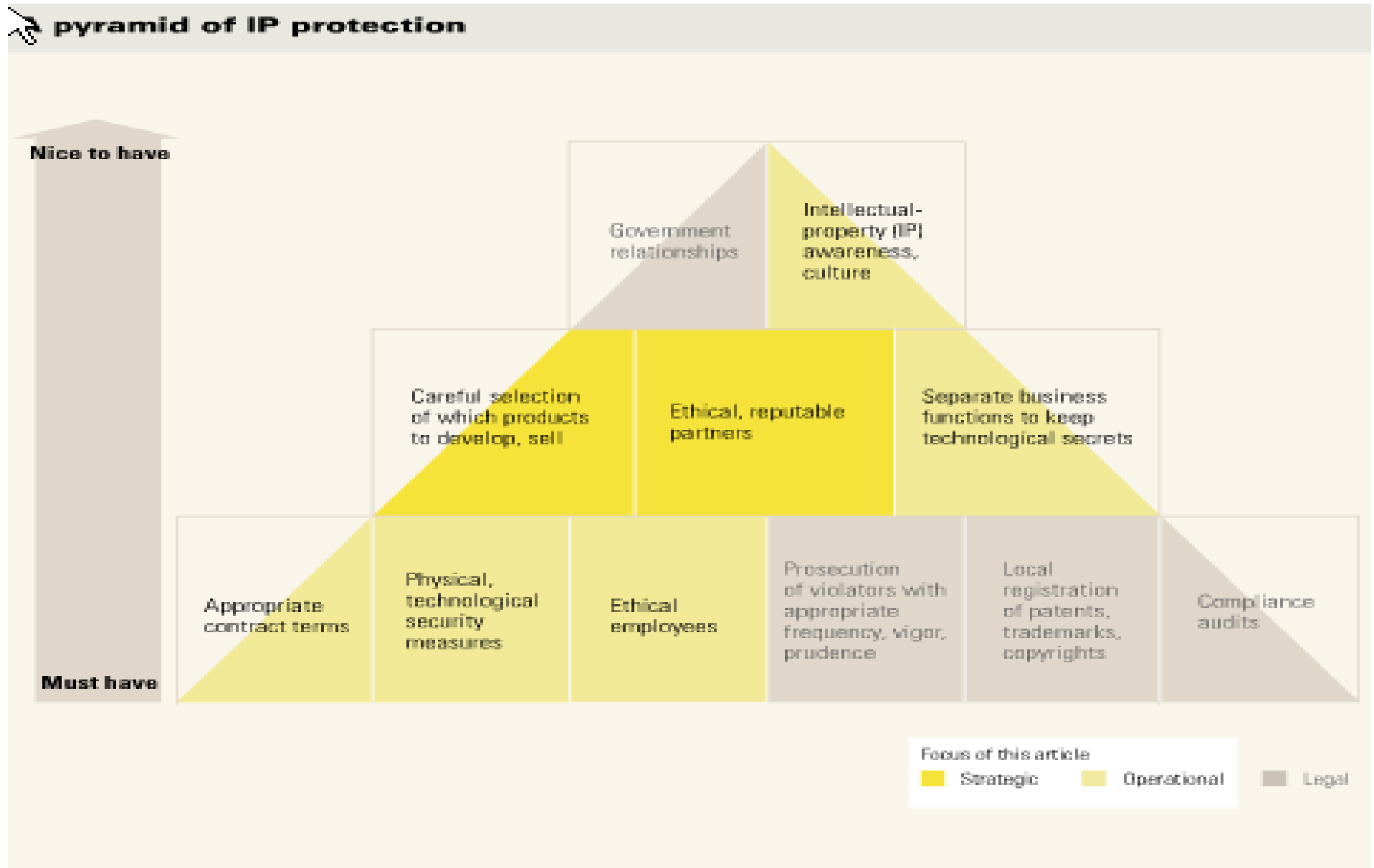
How to Protect your Intellectual Property (怎麼保護您的知識產權)

The best offense is a good defense...and vice versa

- Go on the defense...
 - Employ legal measures...A first-to-file principle
 - Control the production process
 - Focus on human resources
 - Know how to choose suppliers and distributors
 - Keep eye on competitors
- ...And the offense
 - Take legal action
 - Conduct surveillance of suppliers and distributors
 - Control employee turnover
 - Advocate aggressively

http://resources.alibaba.com/article/4117/IP_protection_best_practice_tips.htm

Protecting IP in China



http://www.mckinseyquarterly.com/article_page.aspx?ar=1643&L2=21&L3=35&srId=17&gp=0

Customs Regulations (三個另外星期類)

- Articles bearing marks that are counterfeit or inappropriately using a trademark are subject to seizure and forfeiture.
- Travelers are permitted an exemption and allowed to import 1 item of each type provided that the article is for personal use and not for sale for once every 30 days.
 - E.G. Person arrives with 3 purses all different trademarks, or all the same trademarks, would be permitted only one purse.

IP and Globalized Technology Impact

- For developing countries:
 - understanding IP issues is necessary in their efforts to integrate into world economies
 - evolving system of stronger IP rights in new technologies can ultimately lead to gains in innovation and information
 - Wisely managing IP may lead to additional foreign investment, more licensing of high-quality technologies, and more access to advanced knowledge goods

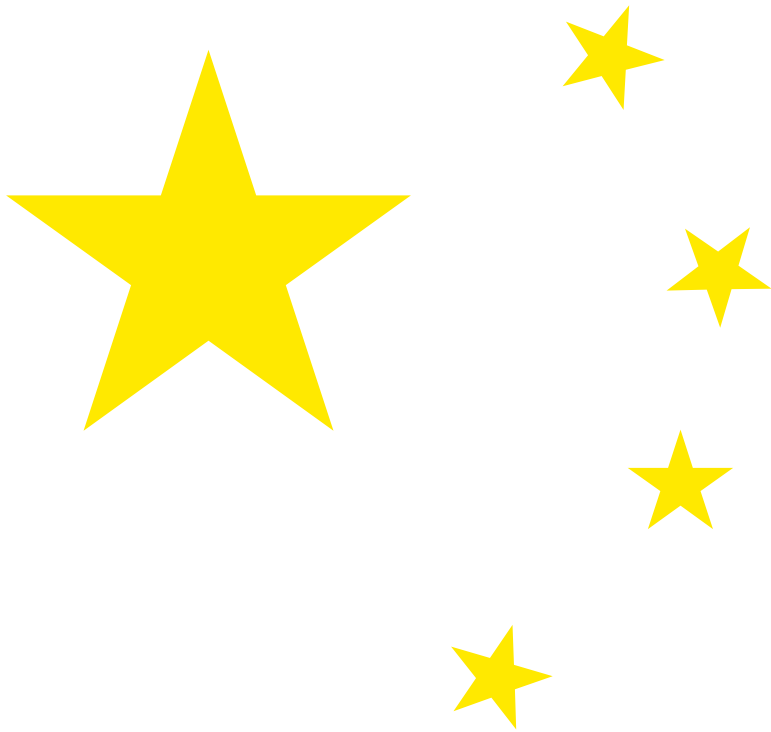
http://assets.cambridge.org/052184/1968/excerpt/0521841968_excerpt.pdf



Future of IP in China

- As China's economy transitions from manufacturing based to one that produces IP, their laws will change to protect their interests
 - This is the same progression that the US underwent



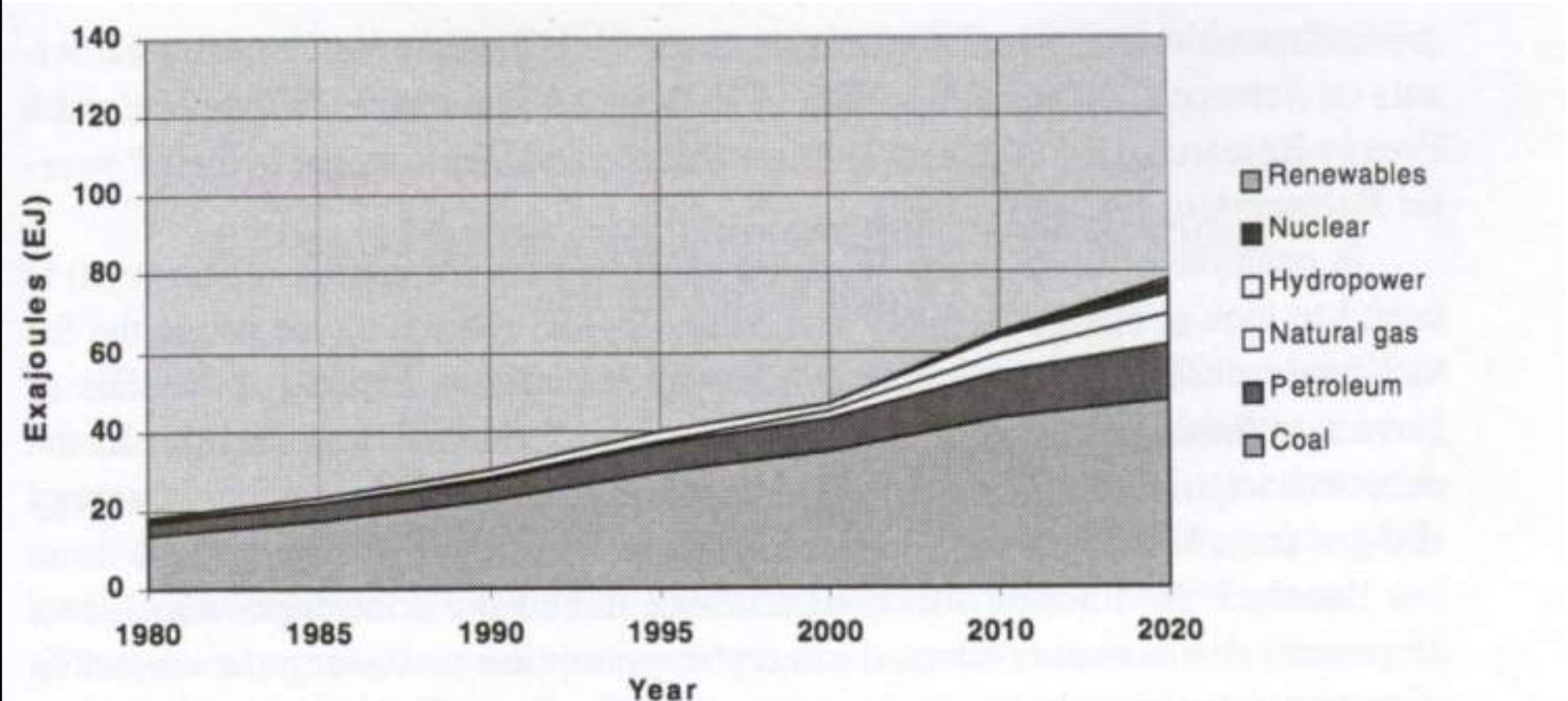


Focus Area: Power and Energy in China



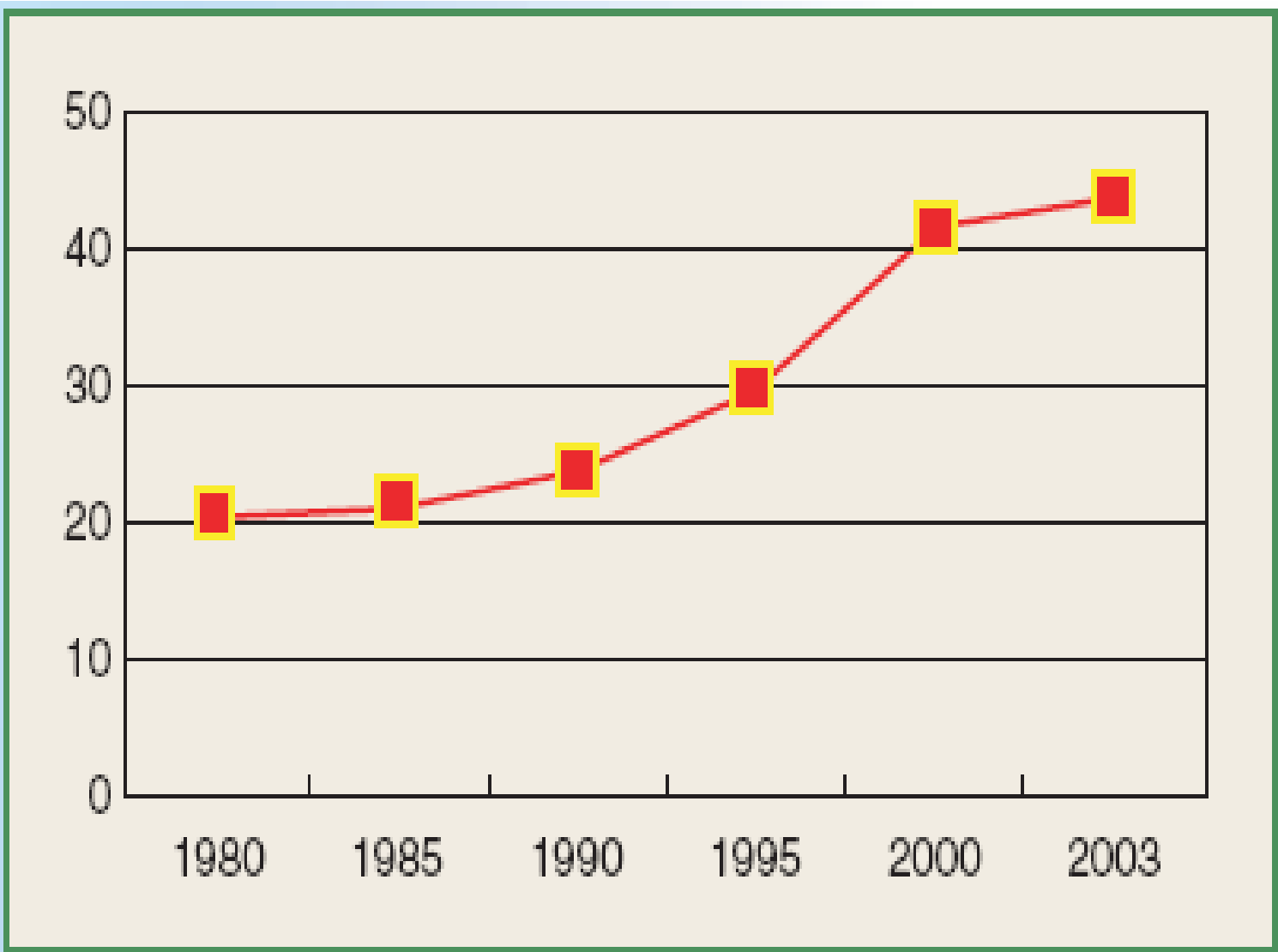
Chinese Commercial Energy Consumption

(Chinese Academy of Engineering, 1997)

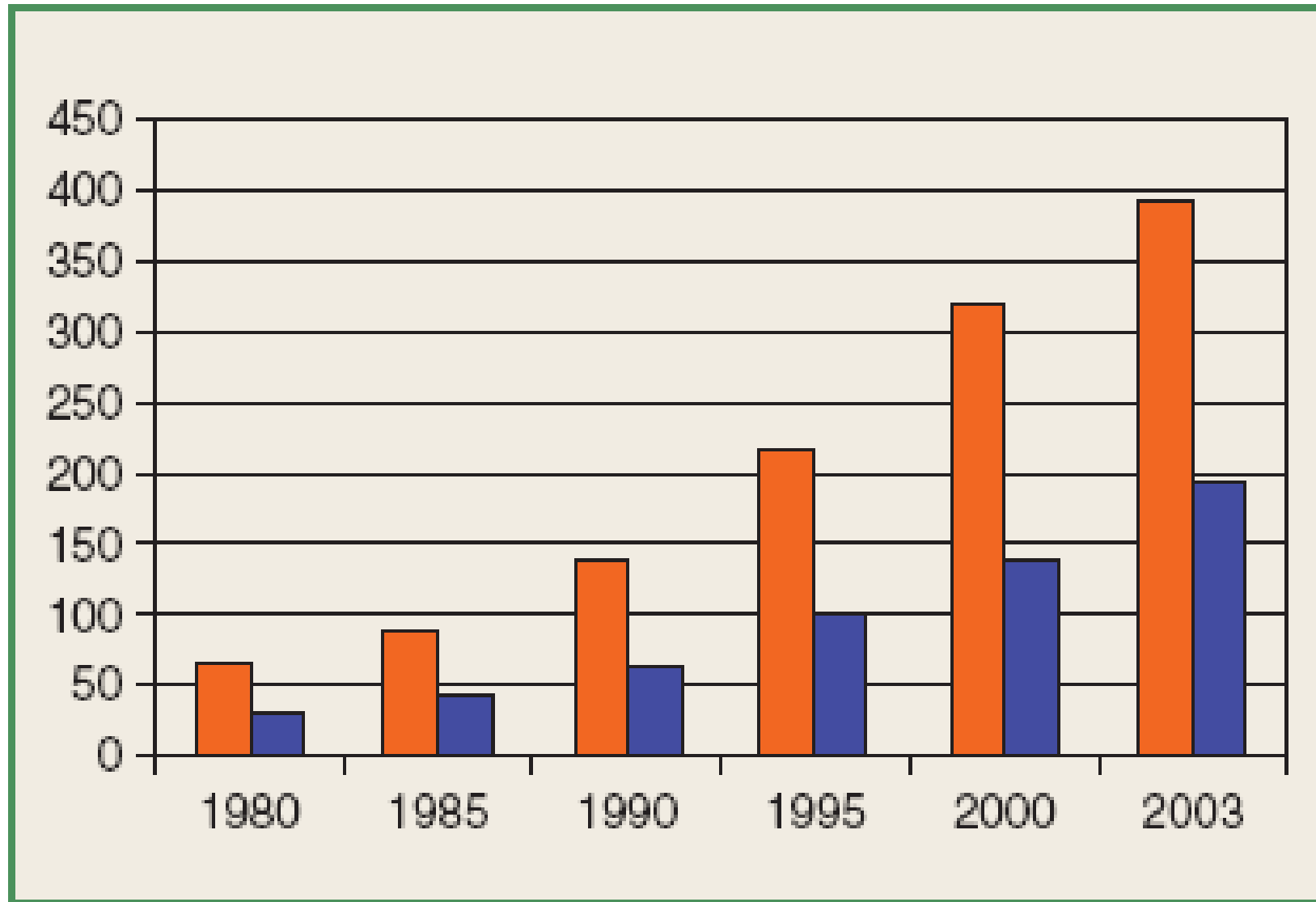


Consider the couplings in GDP and electricity use: quadrupling of GDP between 1980-1995, while doubling the economy's energy demand— due to economic reforms and comprehensive national energy conservation programs since 1980s.

Percentage share of electricity in total energy consumption (increase in the share of electricity in total energy consumption)

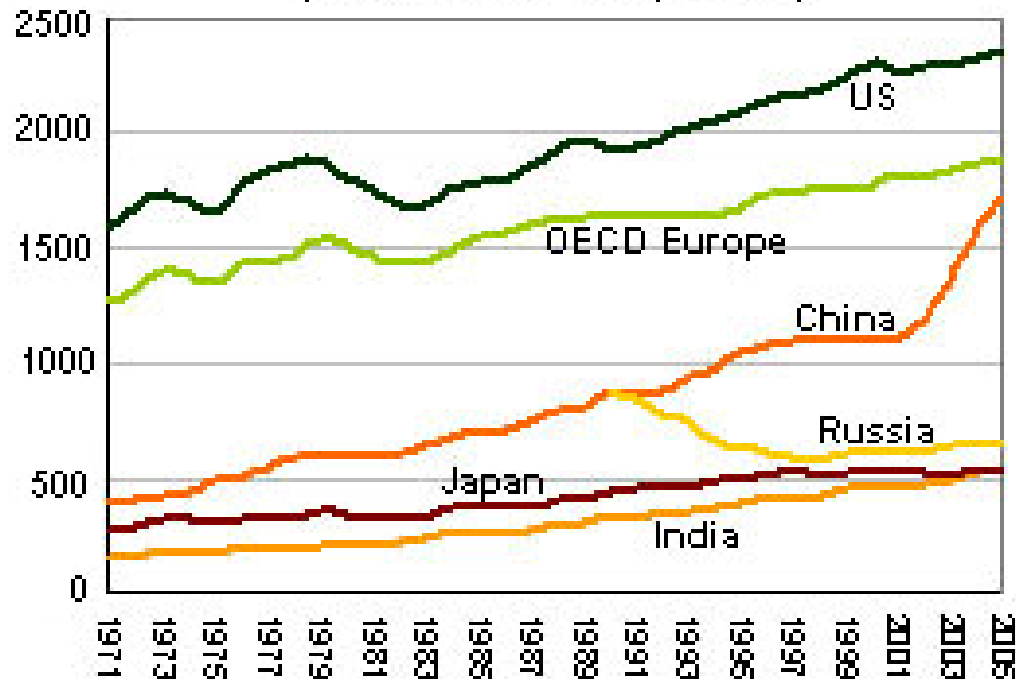


Total installed generation capacity in GW (red columns) and annual electricity production in 10 trillion Wh (blue columns)

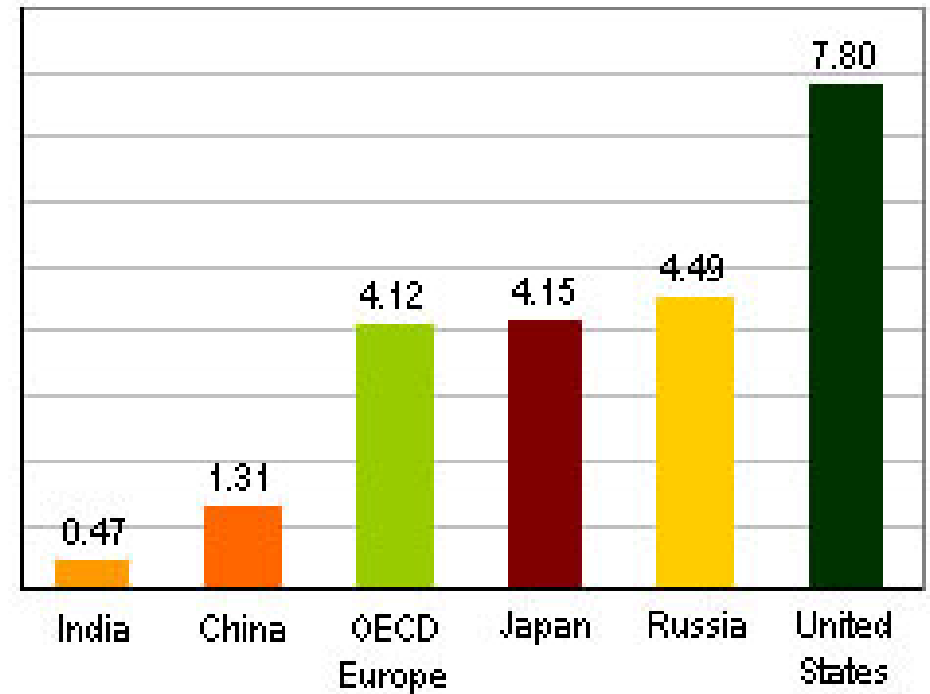


Energy Demand

Total Energy Demand
(million tonnes of oil equivalent)

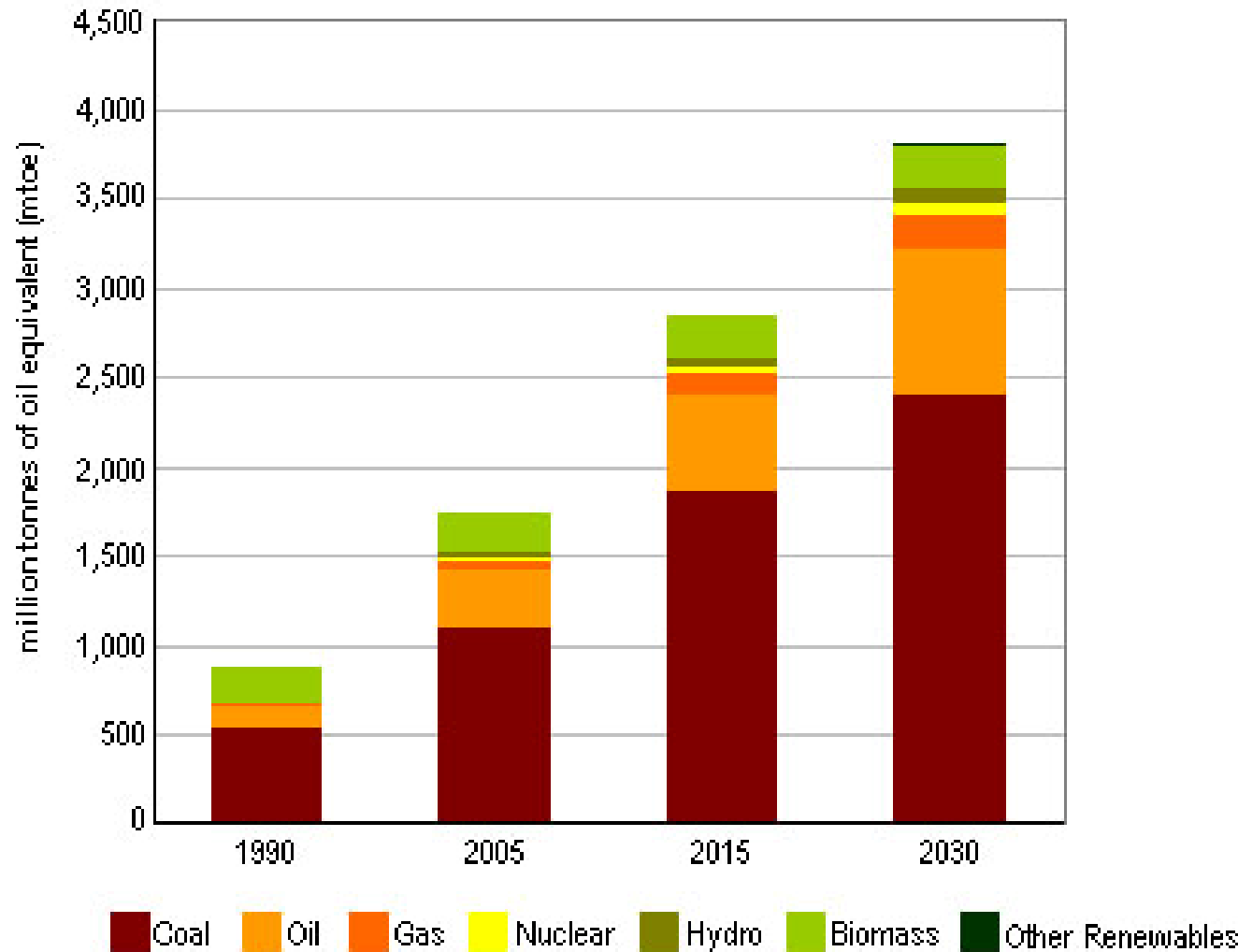


Per Capita Energy Demand
(tonnes of oil equivalent in 2005)



<http://earthtrends.wri.org/updates/node/274>

Projected Energy Growth in China by Energy Source



<http://earthtrends.wri.org/updates/node/274>

Nuclear Power



China has nine operating nuclear power plants, including the Daya Bay facility in Shenzhen.

They plan to spend \$50 billion to build 32 more by 2020.

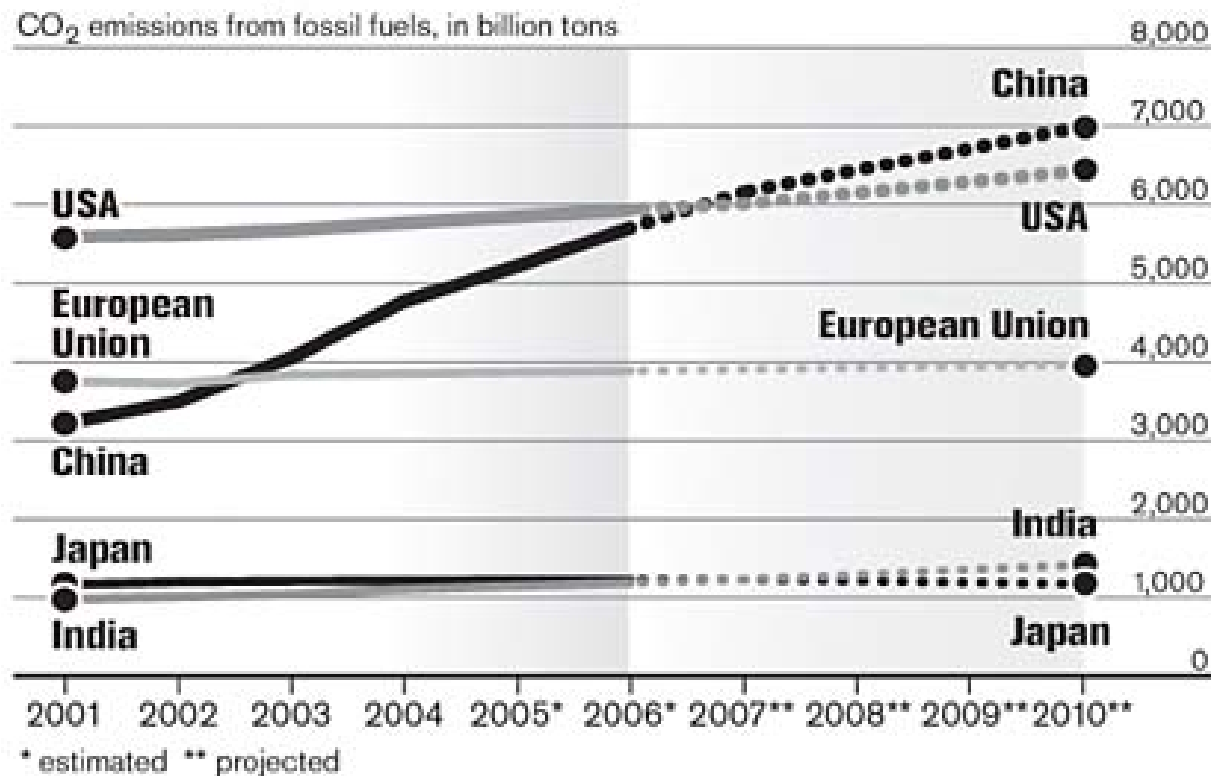
Possibly 300 by 2050.

<http://www.washingtonpost.com/wp-dyn/content/article/2007/05/28/AR2007052801051.html>

CO₂ Emissions

China surging to No. 1 position

Data about China's greenhouse gas emissions has long been controversial because of the Chinese government's faulty record keeping. But new data indicate that China's emissions began to surge in 2001 and have been rising much faster than expected.

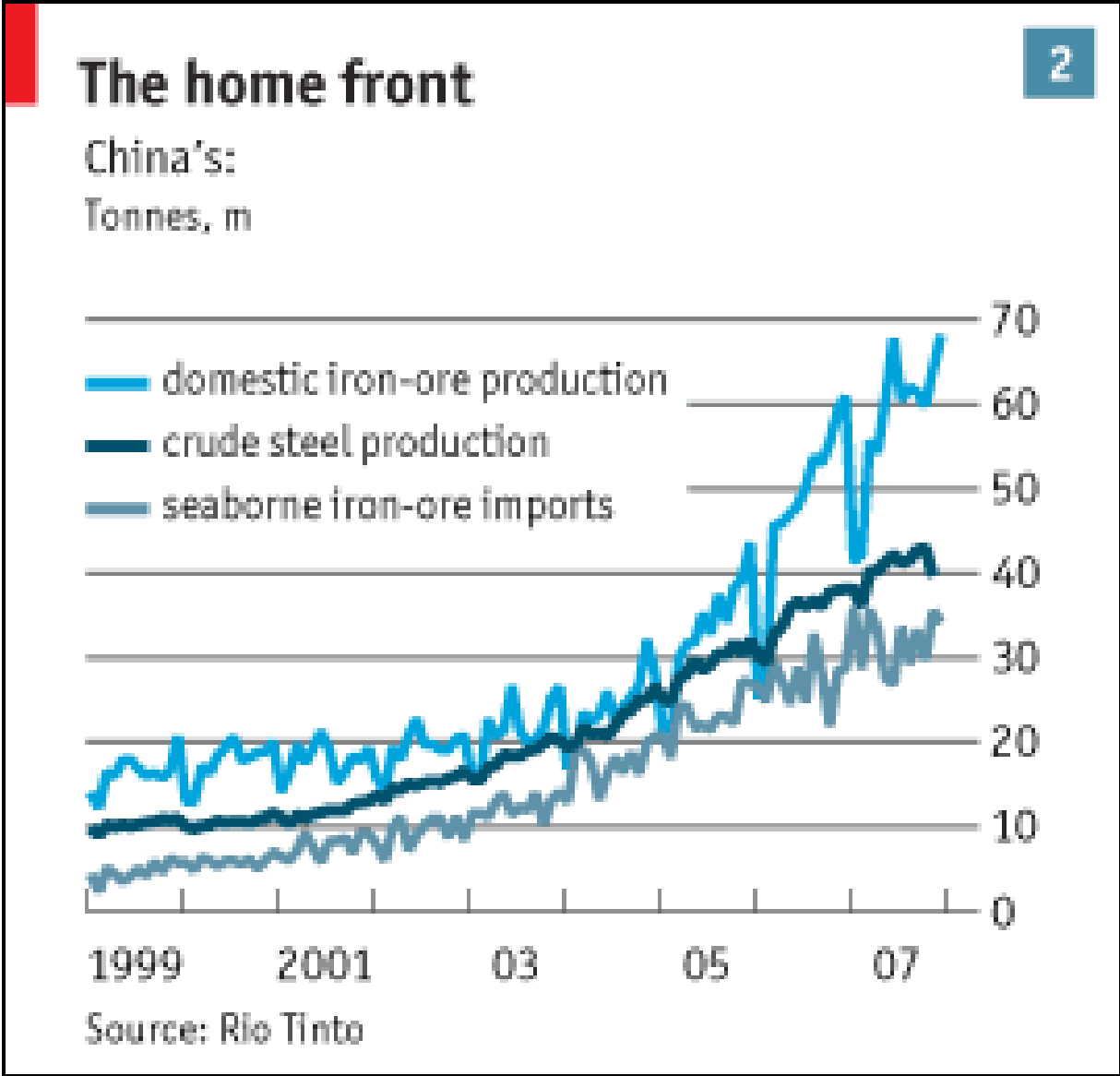


Sources: Chronicle research; China National Bureau of Statistics; International Energy Agency; U.S. Energy Information Administration

The Chronicle

http://futurist.typepad.com/.shared/image.html?/photos/uncategorized/2007/06/24/mn_china.jpg

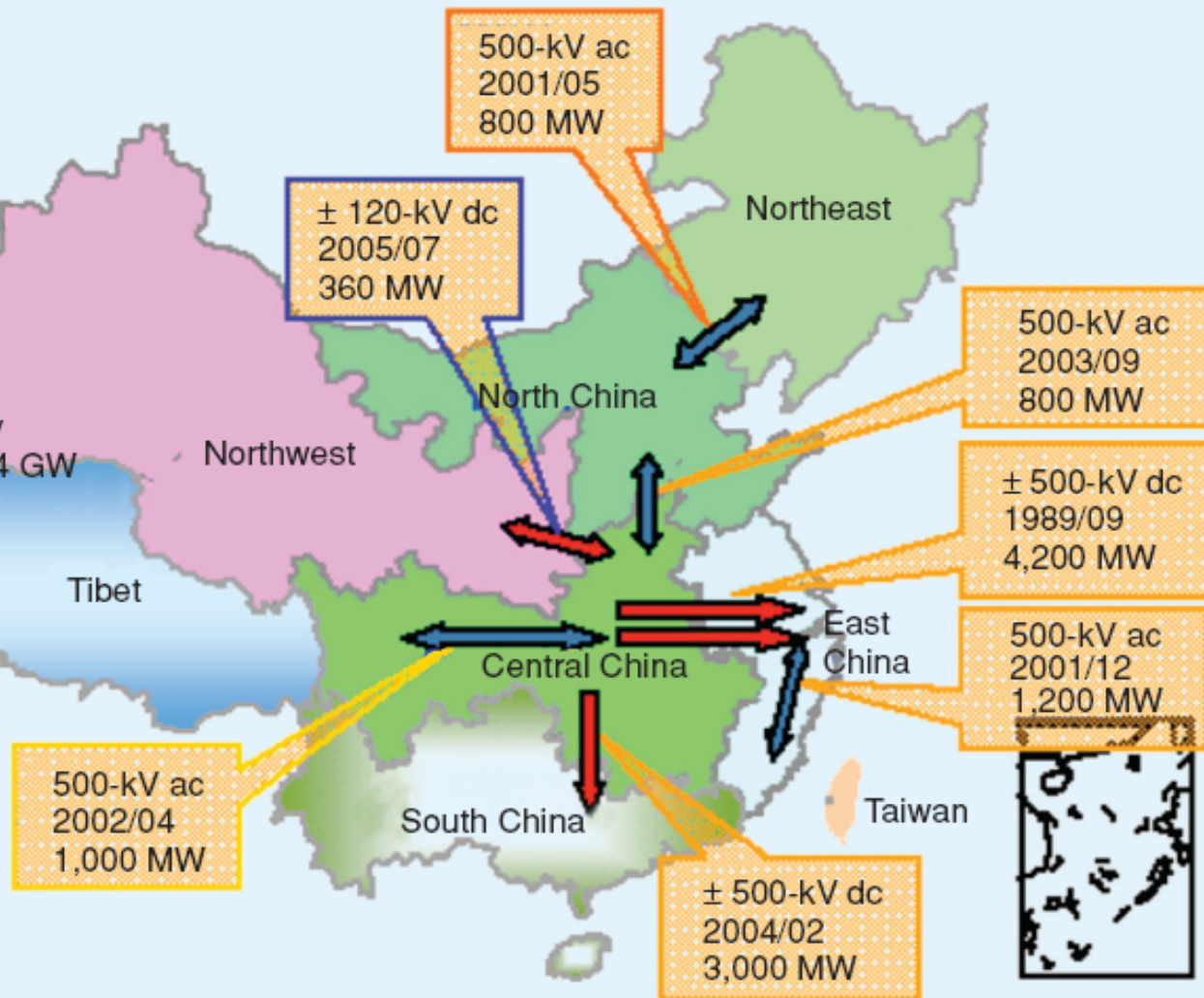
Iron Ore and Steel



Nationwide grid interconnections of China

ac Interconnection:
Northeast–North-
Central China

dc Interconnection:
Central – East China
Central – South China
Central – Northwest
Transmission Capacity
Between Regions: 11.4 GW

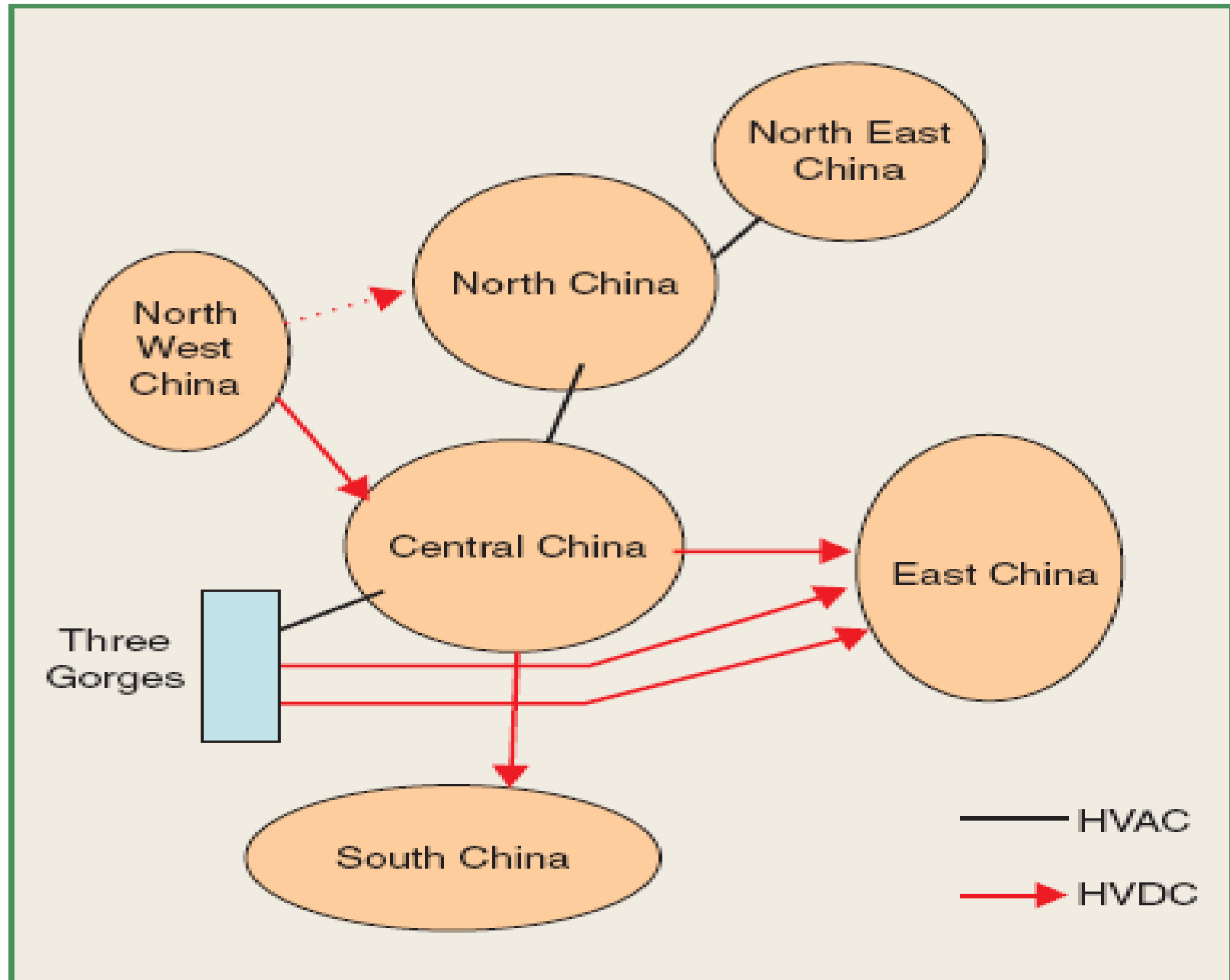


Geographic map of six regional power systems



NC: North China; EC: East China; CC: Central China;
SC: South China; NW: Northwest China; NE: Northeast China

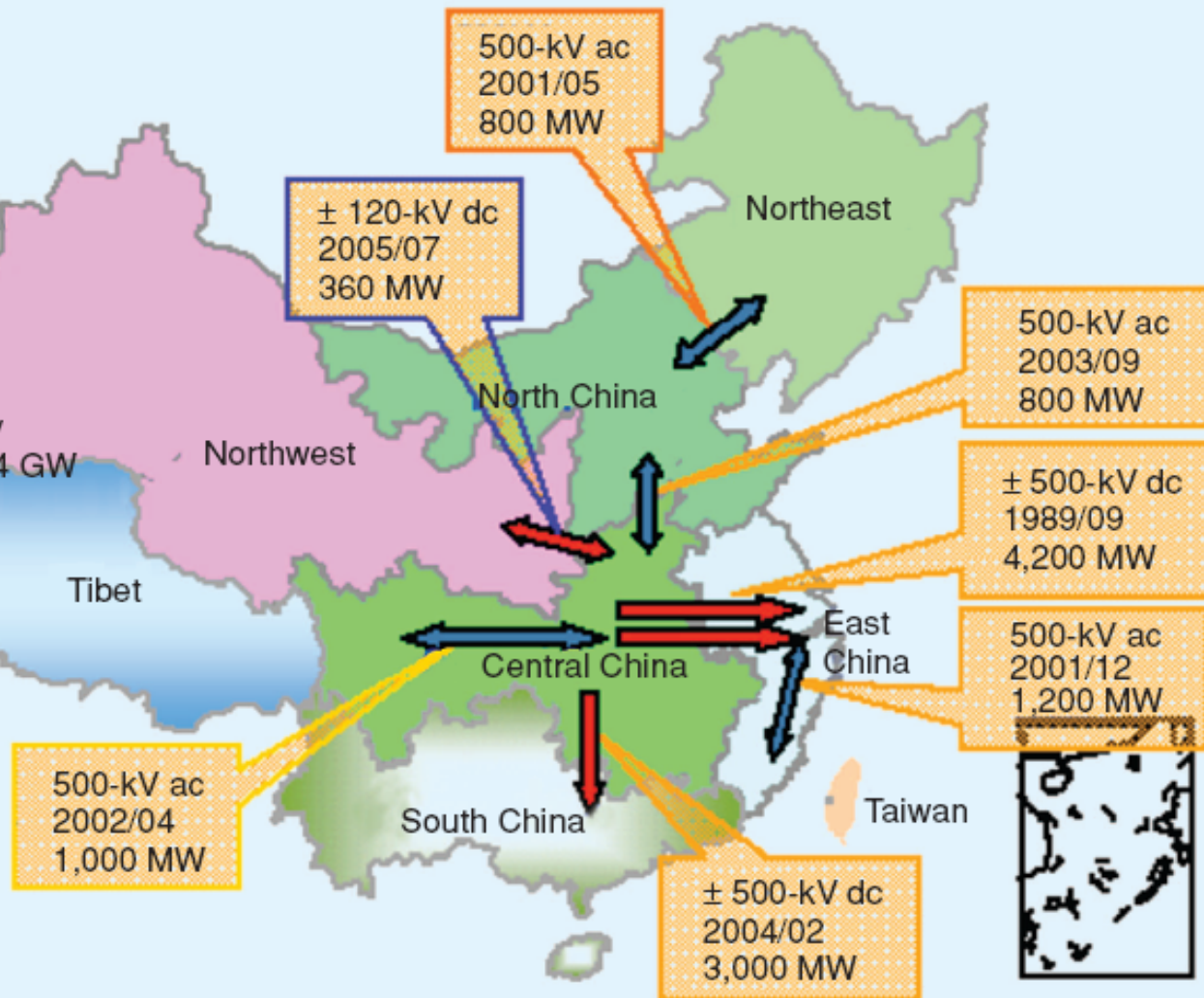
Interconnection of six regional grids in 2005



Nationwide grid interconnections of China

ac Interconnection:
Northeast–North-
Central China

dc Interconnection:
Central – East China
Central – South China
Central – Northwest
Transmission Capacity
Between Regions: 11.4 GW



Recently completed hvac/hvdc projects

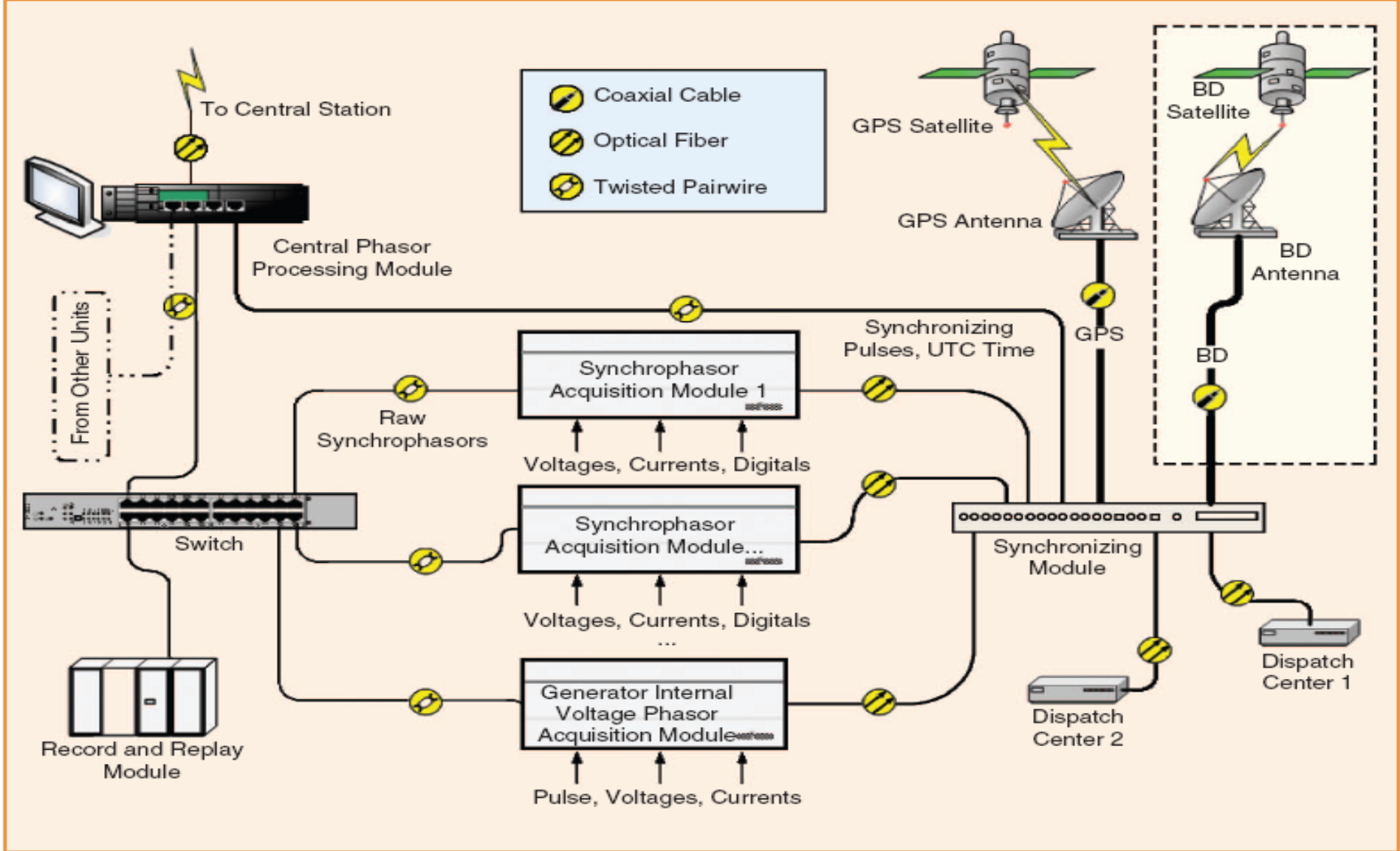
Grid	Location	Type	Capacity	Length	Completion
CC-EC	3G Gezhouba-Shanghai	±500 kV DC	1,200 MW	1,045 km	1991
SC-SC	Guangxi-Guangdong	±500 kV DC	1,800 MW	980 km	2001
CC-EC	3G Longquan-Shanghai	±500 kV DC	3,000 MW	900 km	2002
CC-SC	3G Jingzhou-Guangdong	±500 kV DC	3,000 MW	950 km	2004
CC-NW	Henan-Henan	±120 kV DC	360 MW	Back-to-back	2004
SC-SC	Guizhou-Guangdong	±500 kV DC	3,000 MW	1,000 km	2004
NC-NE	Hebei-Liaoning	500 kV AC	800 MW	167 km	2001
CC-NC	Henan-Hebei	500 kV AC	600 MW	210 km	2003

Central to this is the Three Gorges power grid, consisting of 12-GW HVAC from the Three Gorges to the Central China grid and 7.2-GW HVDC to the East China grid. The first HVDC project in China was in 1987 in Zhejiang province with a 100-MW ± 100-kV underwater cable that spans 54 km. The first HVDC line from Gezhouba (Three Gorges) to Shanghai was completed in 1991, and a number of other HVDC and HVAC lines linking regional grids have been completed in the last few years as listed above. Additional planned HVDC and HVAC transmission projects for the 2006–2010 period include: second 3G-Shanghai HVDC link; second Guizhou-Guangdong HVDC link; NC-NE back-to-back HVDC link; NC-CC back-to-back HVDC link; Guangdong-Hainan underwater HVDC link; Yunnan-Guangdong HVDC link; NC-NE HVAC link; NW-NC HVAC link.

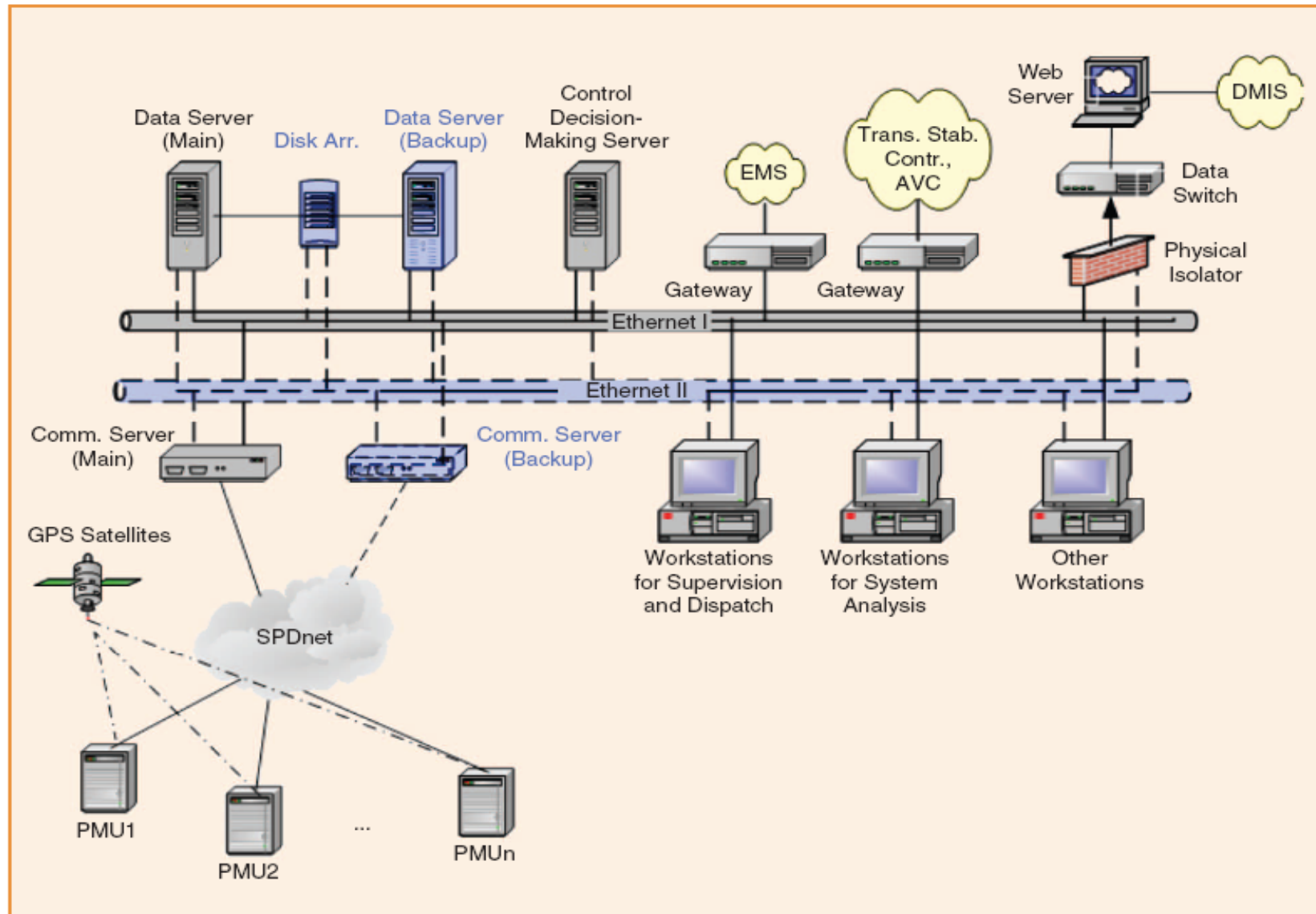
PMUs and WAMS central stations in China



Decentralized PMUs and functional modules



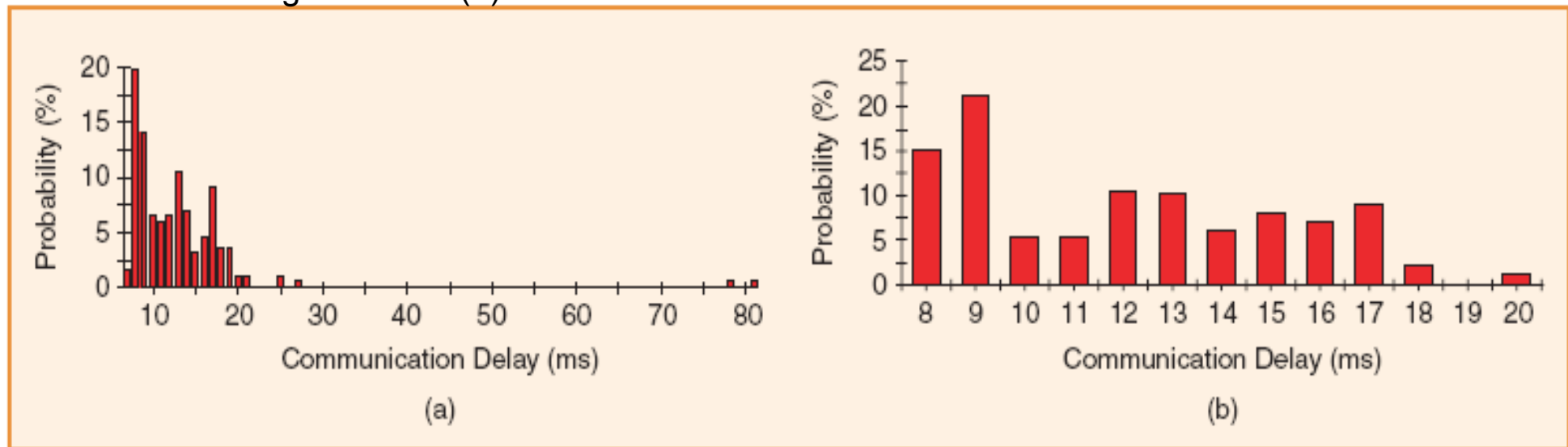
Hardware structure of the WAMS central station



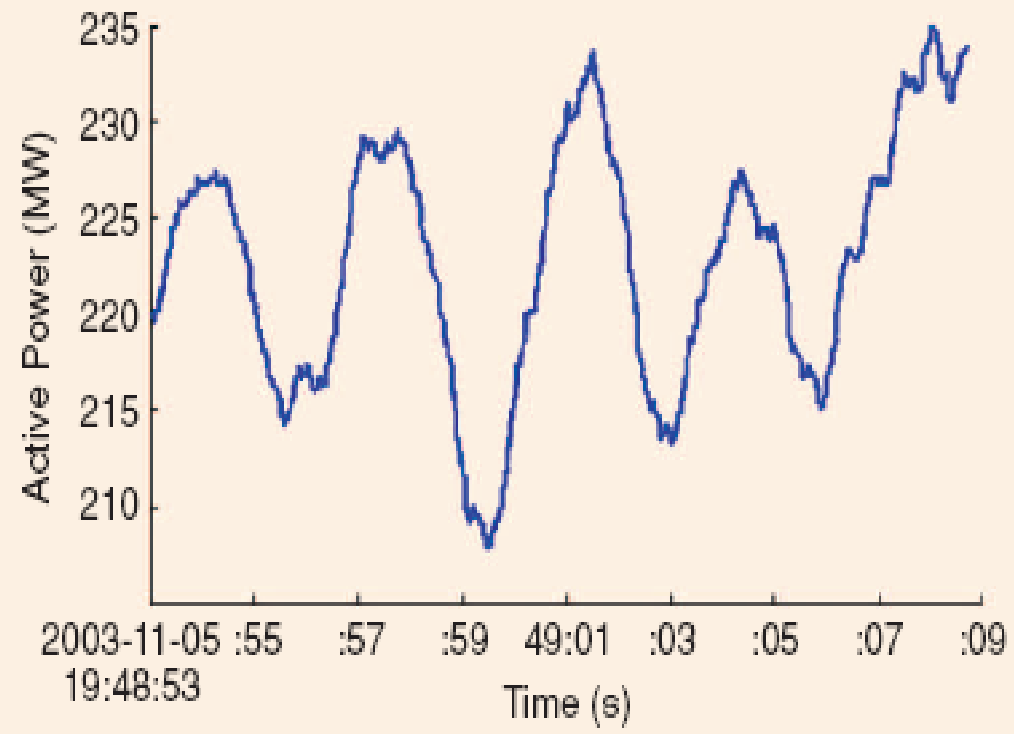
Communication delays between the six PMUs and the central station in Jiangsu Provincial

PMU Plants/ Substations	Status of Network	Max. Delay (ms)	Min. Delay (ms)	Avg. Delay (ms)	Std. Deviation (ms)
Xu Tang	Congested	49	23	39	29
Huai Yin	Congested	21	8	13	10
Nan Tong	Congested	22	9	13	9
Peng Cheng	Congested	27	11	14	6
Xin Hai	Congested	39	17	20	8
Yang Zhou 2nd	Congested	81	7	14	62
Yang Zhou 2nd	Idle	20	8	13	12

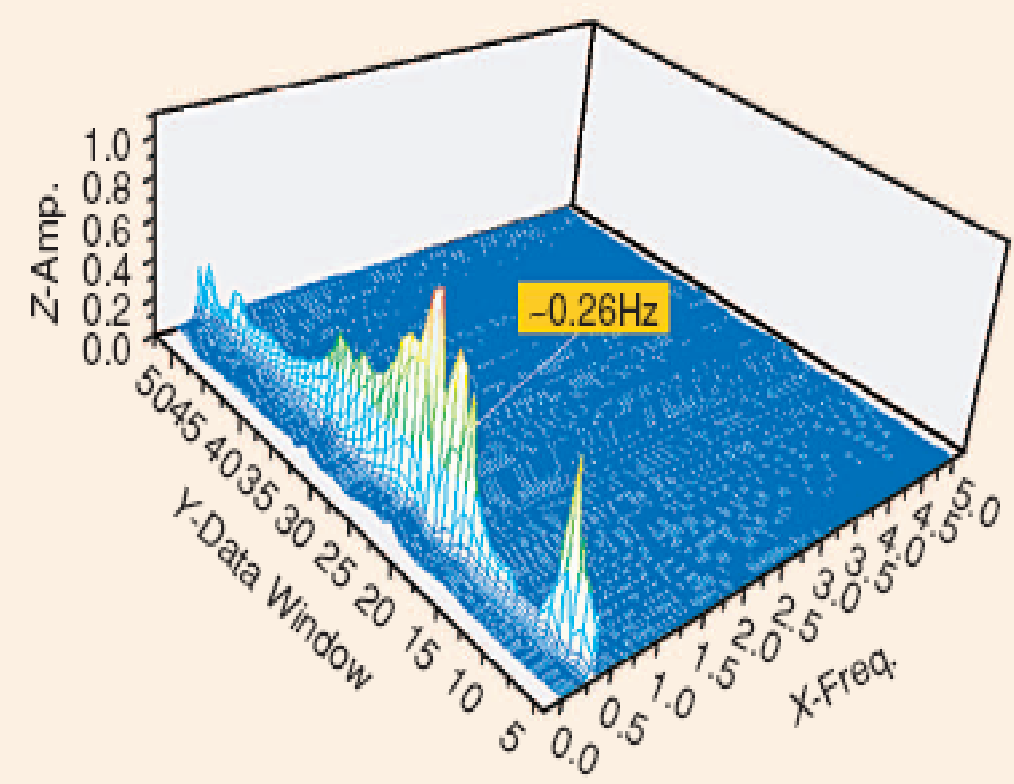
Communication delays between the PMU at Yang Zhou second power plant and the central station:
 (a) the network is congested and (b) the network is idle.



Power oscillation and its online analysis result in the WAMS of Northern—and Central China



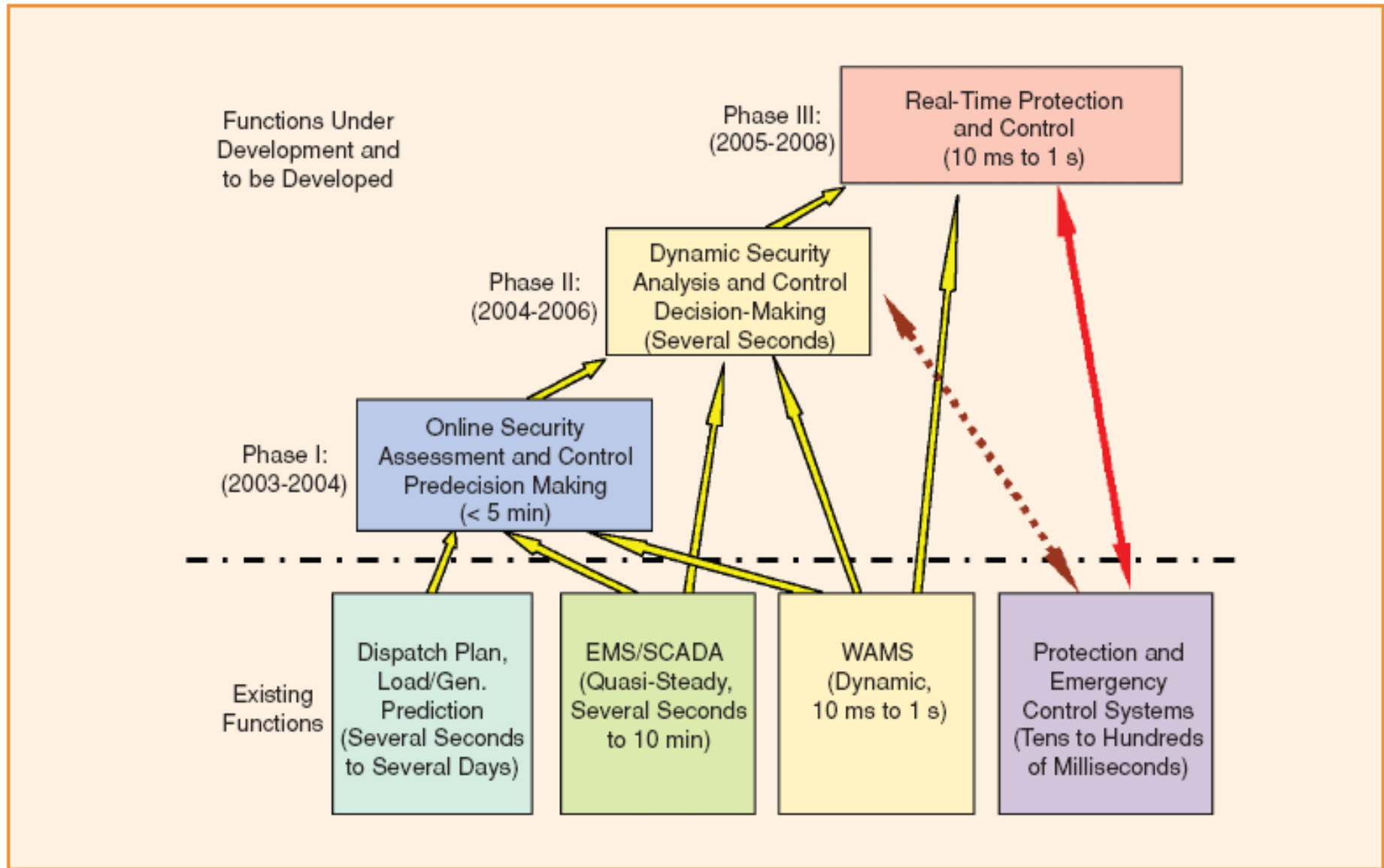
(a)



(b)

(a) the active power along the tie line, and
(b) the frequency spectrum obtained with the online Prony analysis

The three-phase plan of WAMS application in China



Researched and Addressed

Policy Areas to be researched:

- Nuclear Energy Supply
- Energy Transmission and Distribution
- Environmental Pollution
- Localization of Plant Builds
- Nuclear Weapons

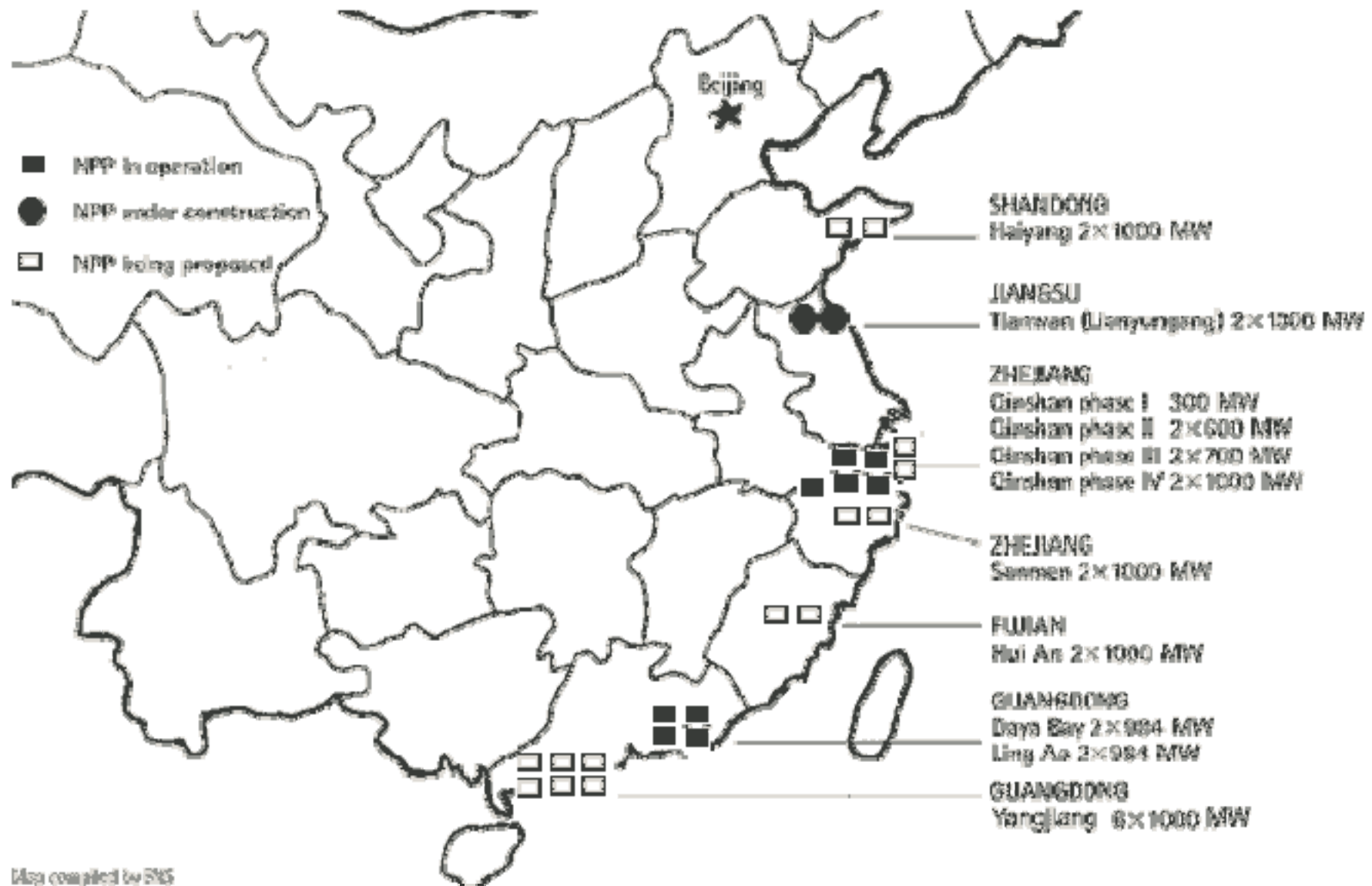


Nuclear Energy Supply

Should China continue to build a nuclear energy supply base?

- Pros
 - Clean Alternative to Coal, Oil, and Natural Gas
 - Smaller Plants produce more Energy
- Cons
 - More Expensive
 - Radioactive Materials
 - Potential Environmental Disasters
 - Public Perception and Sensitivity
- Cost
 - \$1,200 to \$1,500 per Kwh
 - Decommissioning costs are high
 - Costs go on well after end of production
- Benefits
 - Less Dependence on Importation of Oil
 - Use Less Natural Resources

Current and Proposed Nuclear Power Plants in China



Energy Supply Transmission and Distribution

Should the Chinese Government Deregulate the Transmission Infrastructure?

- Pros
 - Cheaper Operating Costs
 - Channels Owned by Government
- Cons
 - Deregulation of Transmission
 - Potential Terrorist Attacks
- Costs
 - Less Cost in Transportation
- Benefit
 - Efficiency

Environmental Pollution

Should the Chinese Government Utilize Nuclear Energy to Help Curb Pollution?

- Pros
 - Less Emissions
- Cons
 - Radioactive Waste
 - Raises Temperatures of Local Water Resources
 - Meltdown Potential
 - Harmful to Humans
- Costs
 - High Long-term Costs for Safe Storage
 - Decommissioning Costs
 - Environmental Impact (Clean-up, treatment, etc.)
- Benefits
 - Less problems with extraction of natural resources

Localized Plant Builds

Should the Chinese Government mandate Localized Building of Nuclear Power Plants?

- Pros
 - Monetary gains to local towns
 - Knowledge kept locally
- Cons
 - No influx of new ideas
 - Cannot support demand
- Cost
 - Cheaper to use Chinese resources than import
- Benefits
 - Develop Local Talent
 - Less Dependent on Foreign Technology

Nuclear Weapons

Should China maintain its current policy of “Minimum Deterrence” with regards to Nuclear Weapons?

- Pros
 - Need to be Provoked
 - Prevents False Alarms
- Cons
 - Potential to be Hit first with Nuclear Weapons
 - Cannot Respond Quickly
 - Trust in Other Countries
 - Complacency
- Costs
 - Life
 - Nuclear Fallout
 - International Relations
- Benefits
 - Smaller Arsenal
 - Less Nuclear Development

Extrapolations & Meanings

- Look at the results upon the GDP and the country's economic growth
- Understand how and where China's S & T development is leading the country
- What does this mean to the US and the World?
- What were the measures of success and is China reaching its goals



Discussion

- How successful is China in creating and following S & T policy?
- Are the policies effective?
- Are there other things should China consider to bolster its economic strength?



SWOT Analysis: China

Strengths

Weaknesses

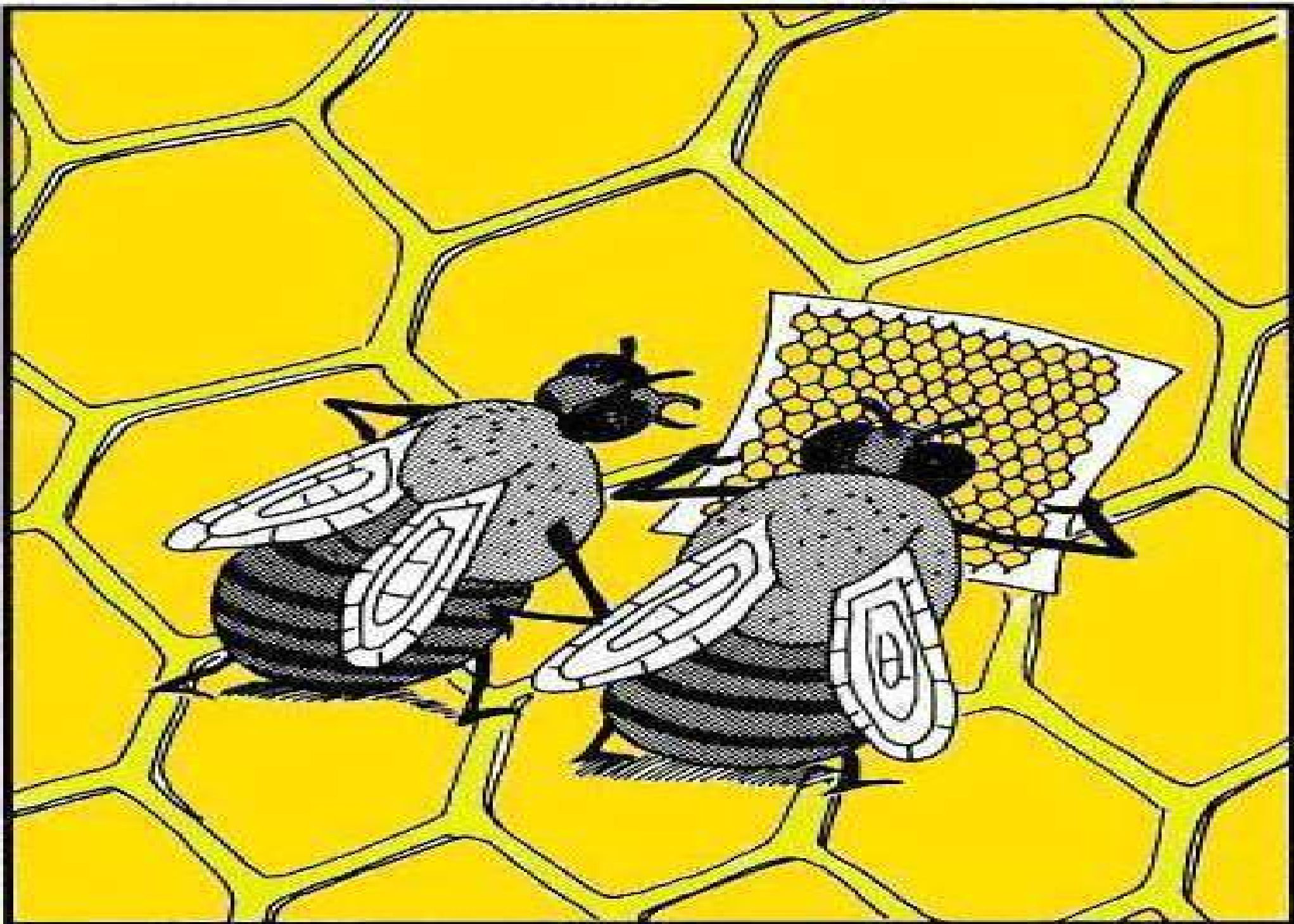
Internal

Opportunities

Threats

External





So, Where are we exactly?

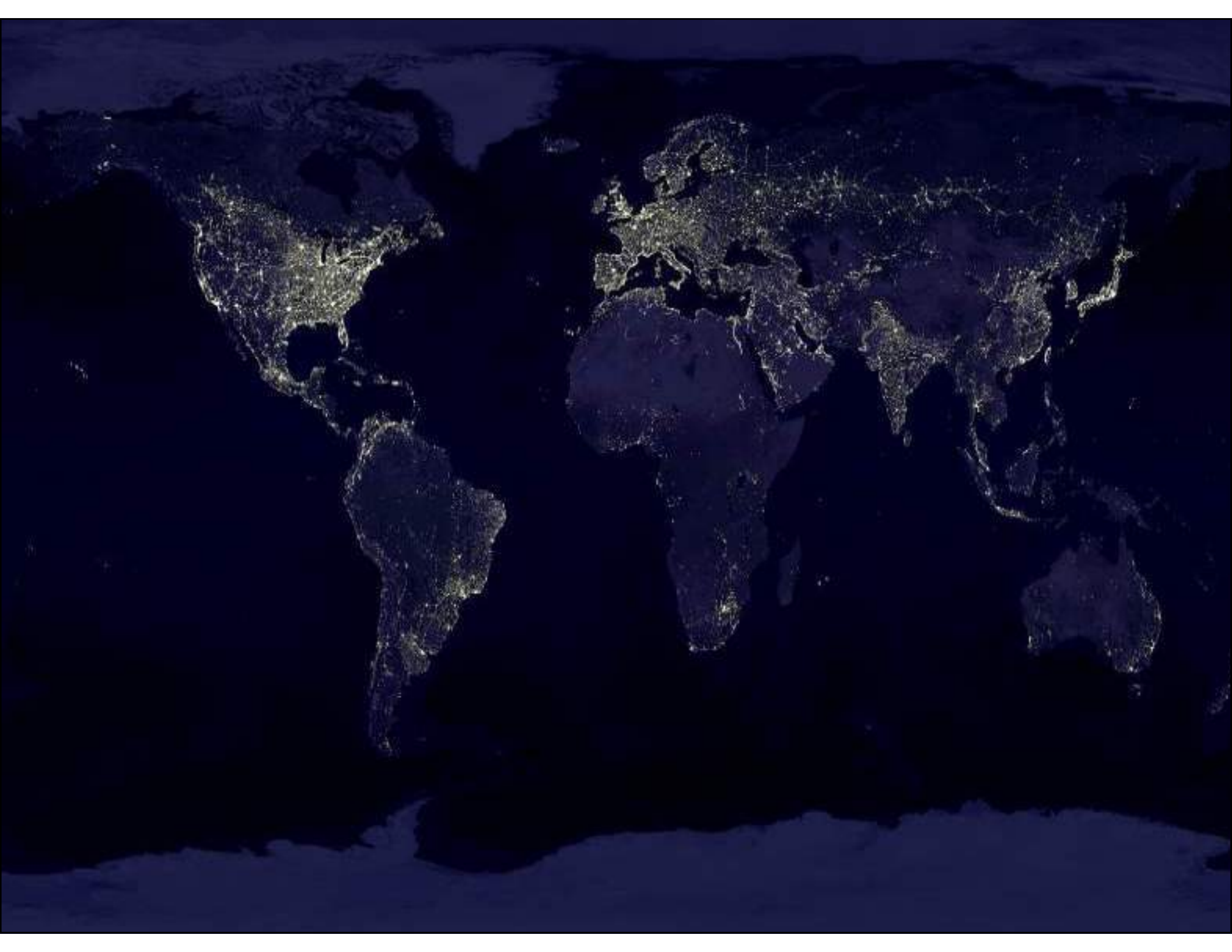
ENERGY and Smart Grid

Context: Cities with 10 million people

- By 2020, more than 30 mega-cities in the now less-developed world. By 2050, nearly 60 such cities.



- Increased population creates need for more resources. World's electricity supply will need to triple by 2050 to keep up with demand, necessitating nearly 10,000 GW of new generating capacity.

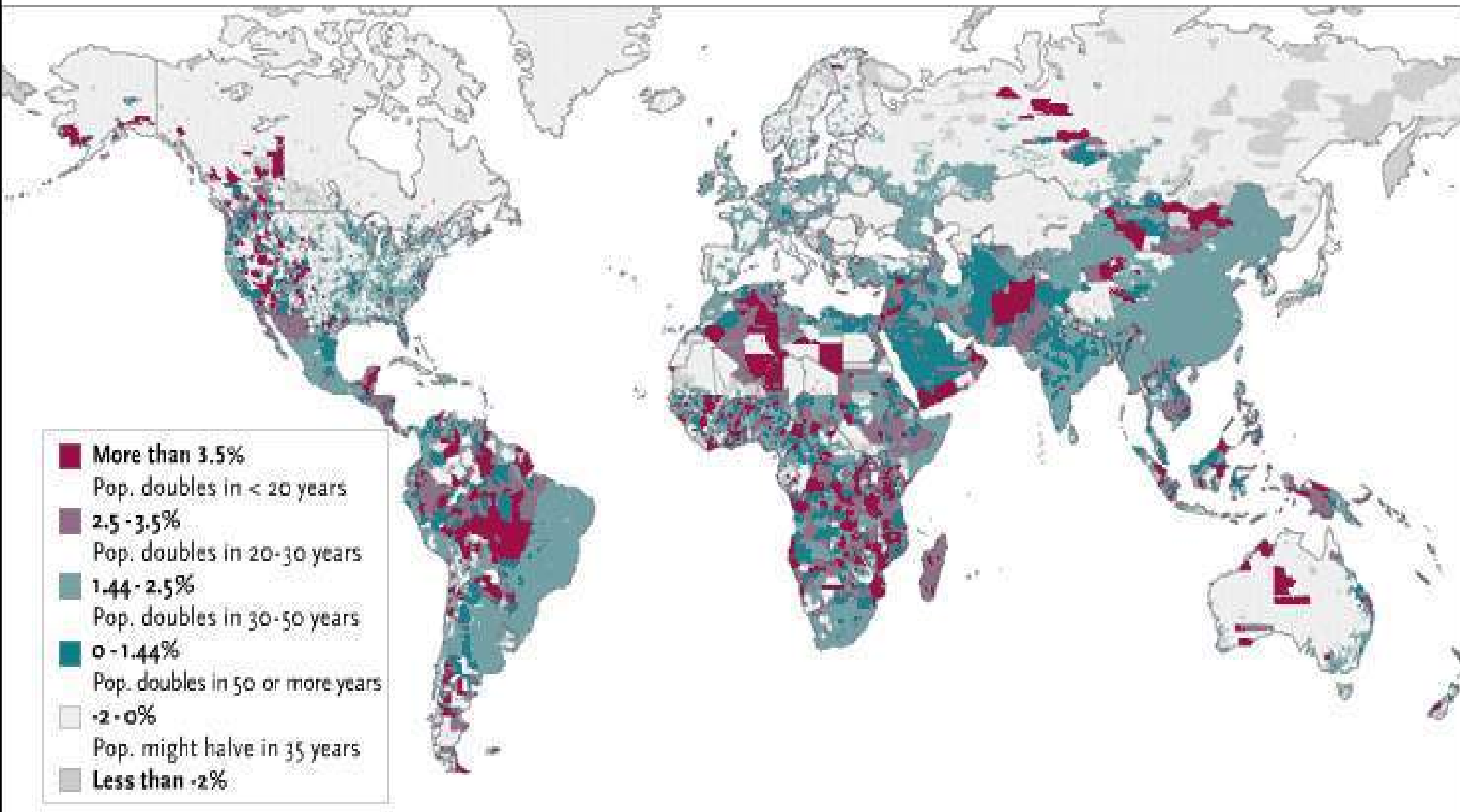


The Energy Gap



- Half the world's population subsists on agrarian or lower levels of energy access, and
- Their population density generally exceeds the carrying capacity of their environment

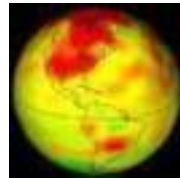
Context: Earth population growth



What Lies Ahead?

The world faces enormous problems
– here is one person’s list of the top 10

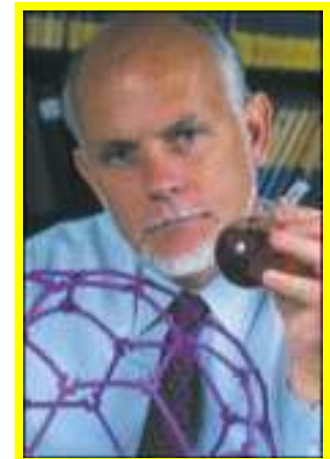
1. **ENERGY** (carbon-free)
2. WATER
3. FOOD
4. **ENVIRONMENT**
5. POVERTY
6. TERRORISM & WAR
7. DISEASE
8. EDUCATION
9. DEMOCRACY
10. POPULATION



Rick Smalley, Rice U.
(1943-2005)

Nobel Prize 1996

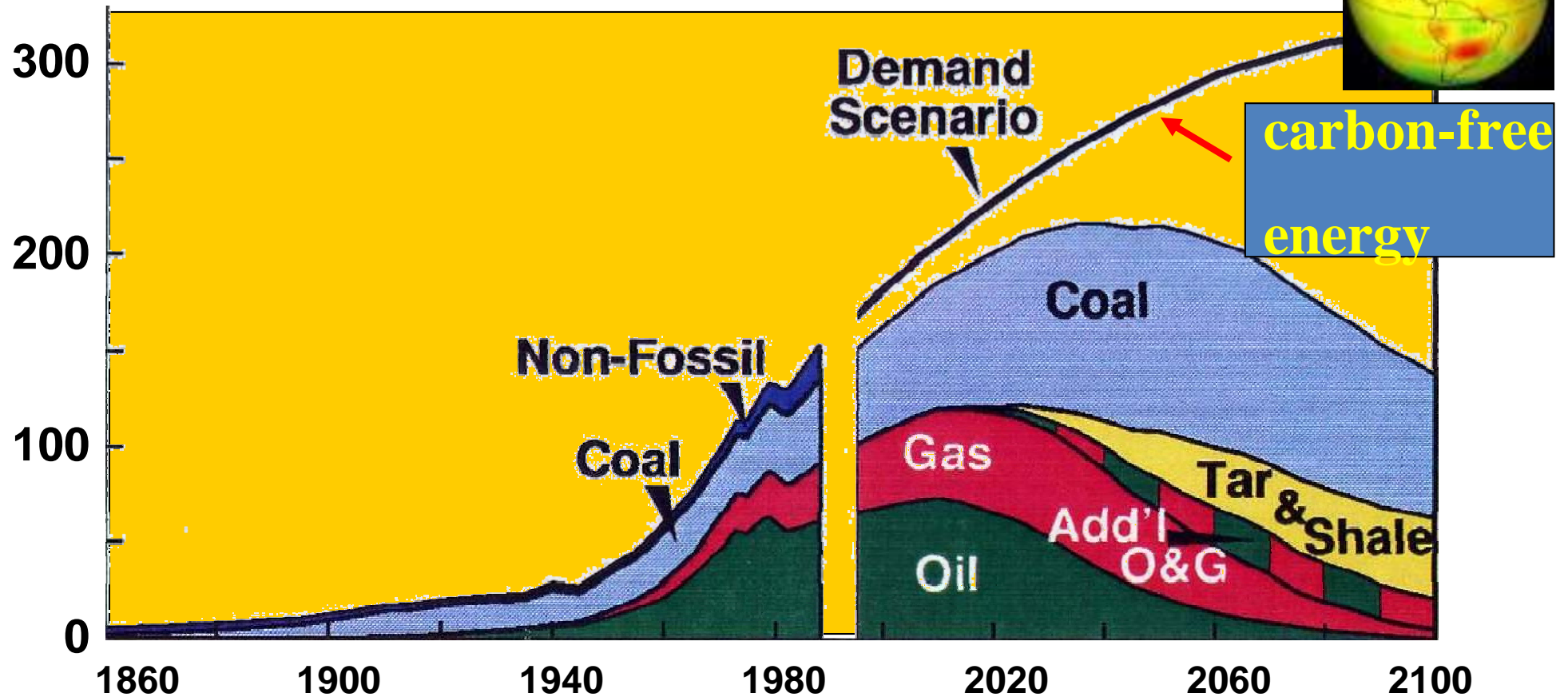
“CIVIC SCIENTIST”



World Energy

Rick Smalley, Rice U.

Millions of Barrels per Day (Oil Equivalent)

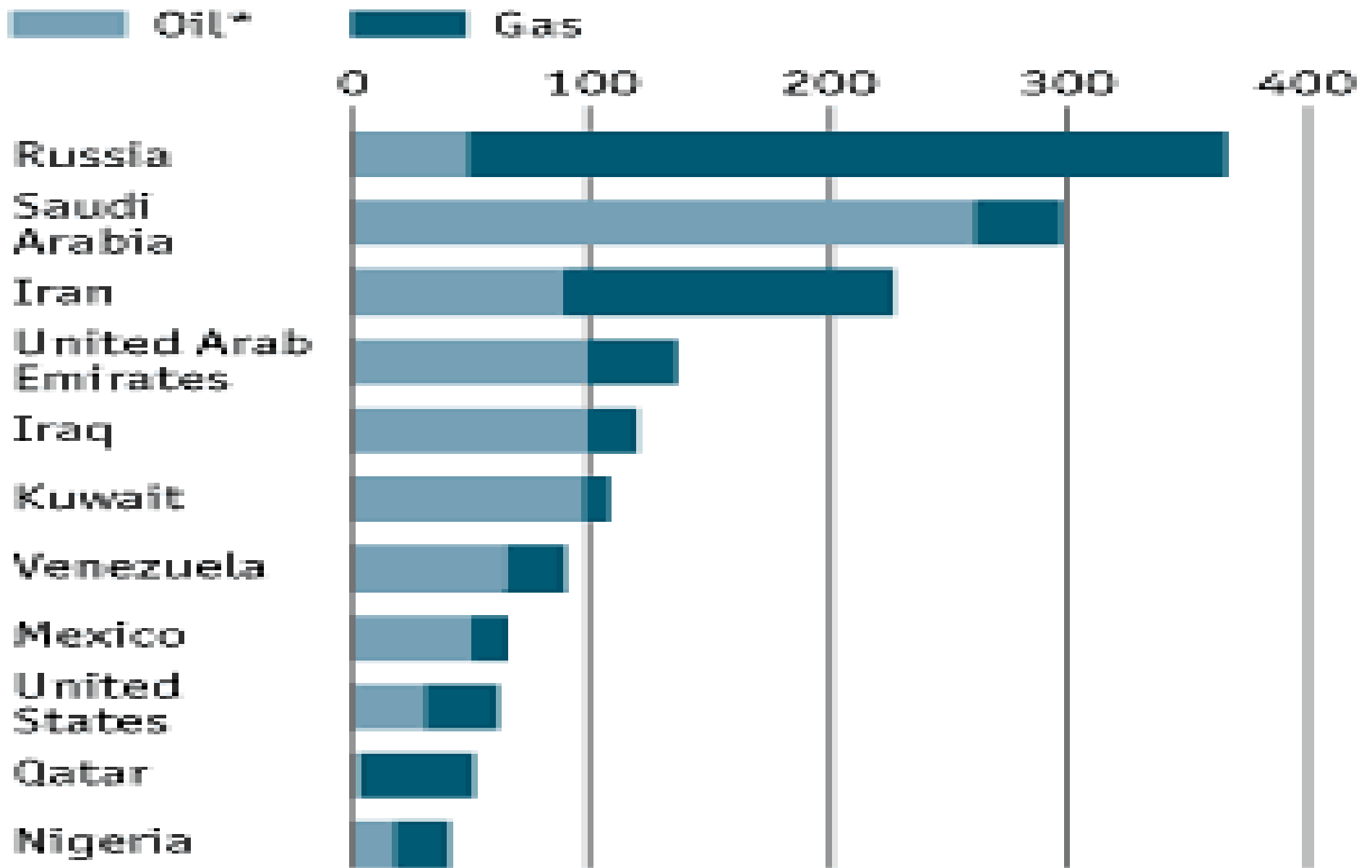


Source: John F. Bookout (President of Shell USA), "Two Centuries of Fossil Fuel Energy" International Geological Congress, Washington DC; July 10, 1985. Episodes, vol 12, 257-262 (1989).

Resourceful

Largest proved oil and gas reserves

Barrels of oil equivalent, bn



Source: PFC Energy

*Includes condensates

Social Conditions and Access to Electricity

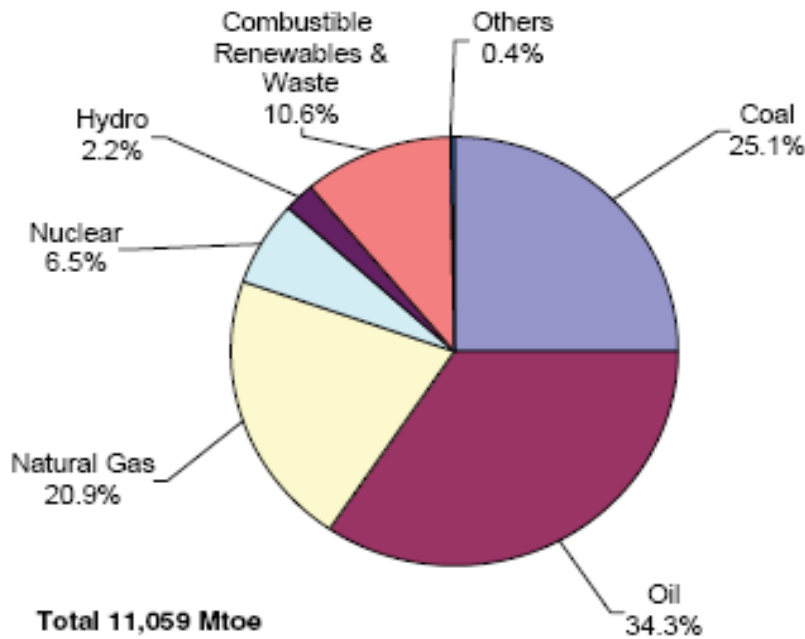


Figure 1. World total primary energy supply (2004) by source. Note: Mtoe is million tons of oil equivalent.¹

Annual GNP/capita

10^5

10^4

10^3

International Collaboration

Global R&D, global investment, global peace, global technologies

Amenities

Education, recreation, the environment, intergenerational investment

Basic Quality of Life

Literacy, life expectancy, sanitation, infant mortality, physical security, social security

Survival

Food, water, shelter, minimal health services

Annual kWh/capita

10^4

10^3

10^2

Source: Dr. Chauncey Starr

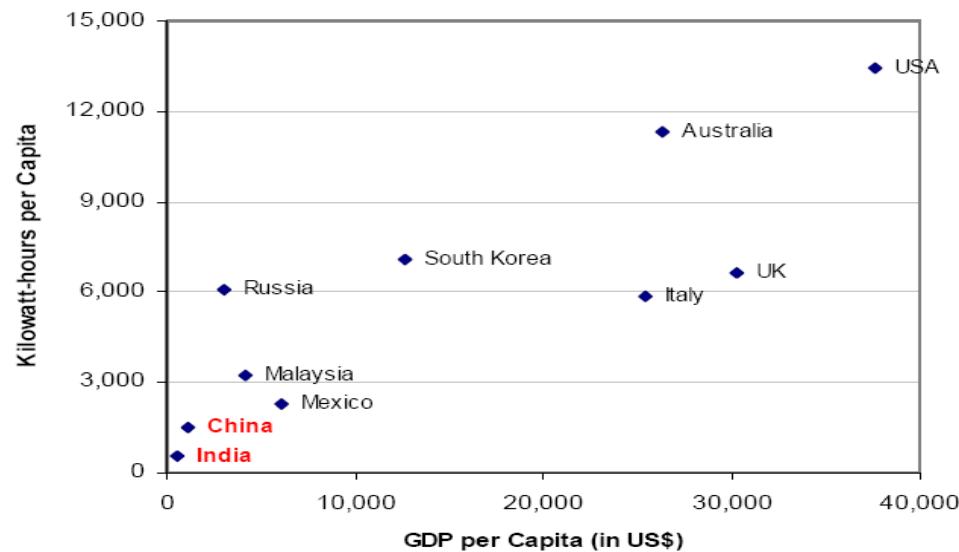


Figure 1: Electricity Usage Per Capita

Source: United Nations' *Human Development Report, 2005*.

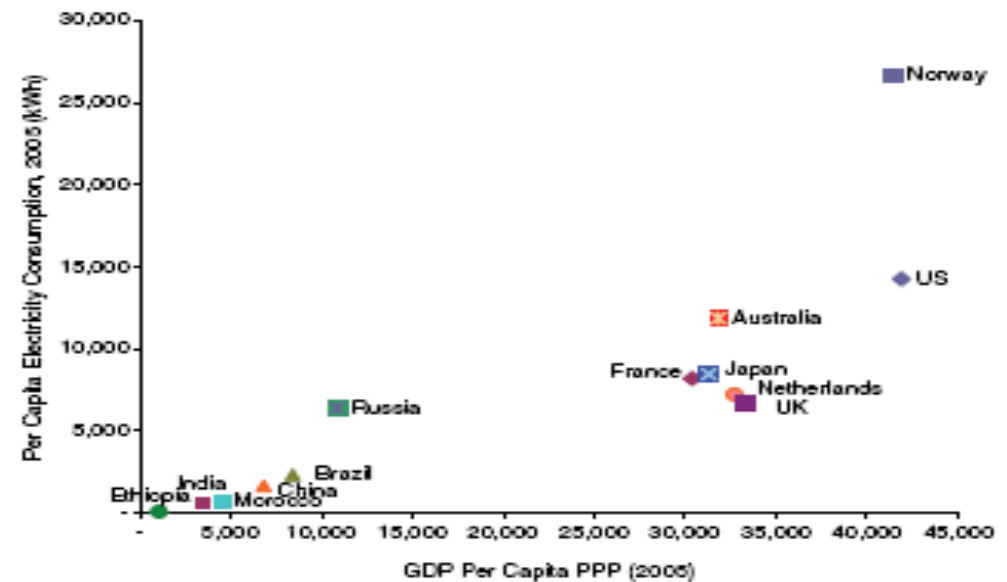
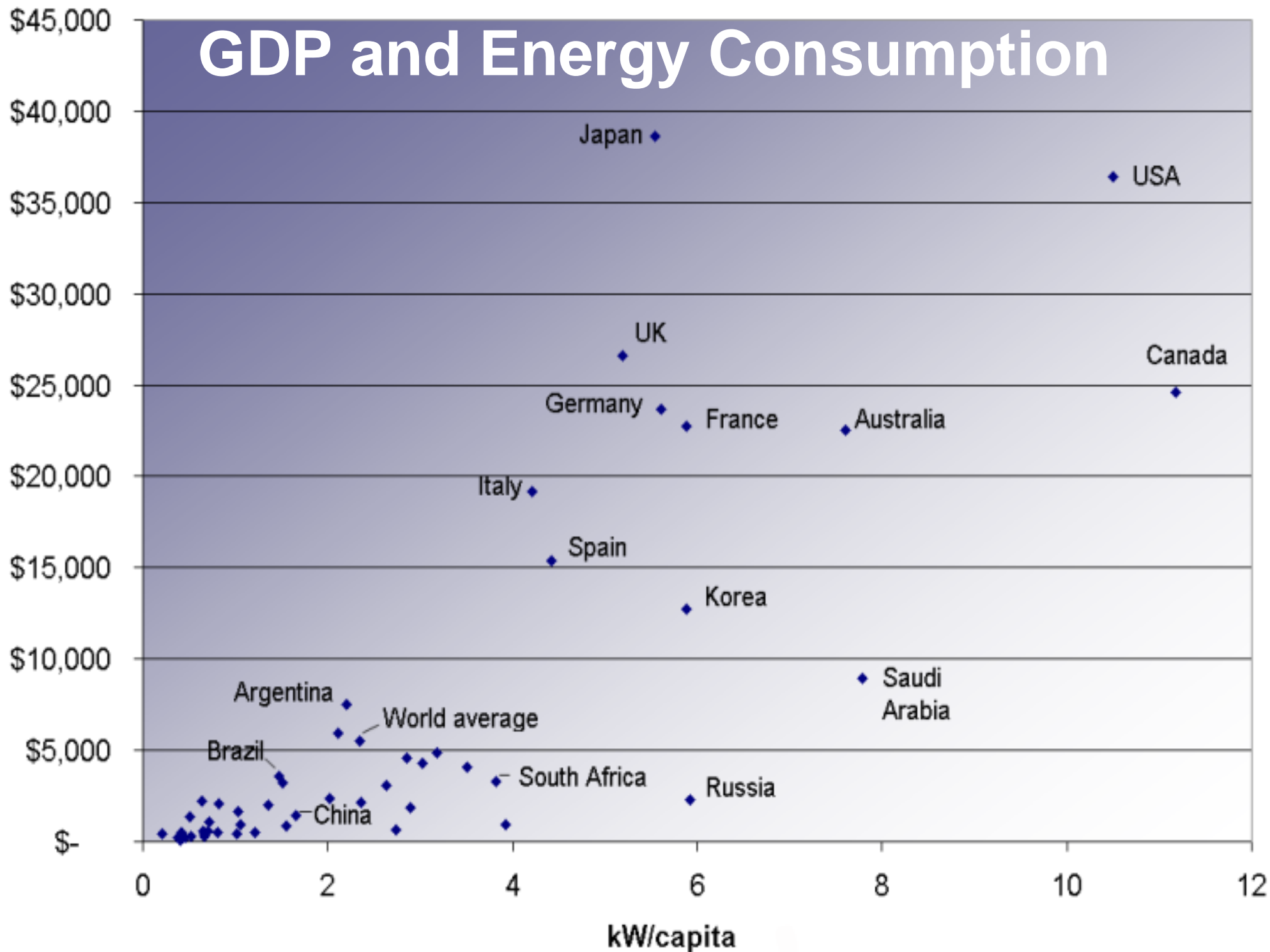


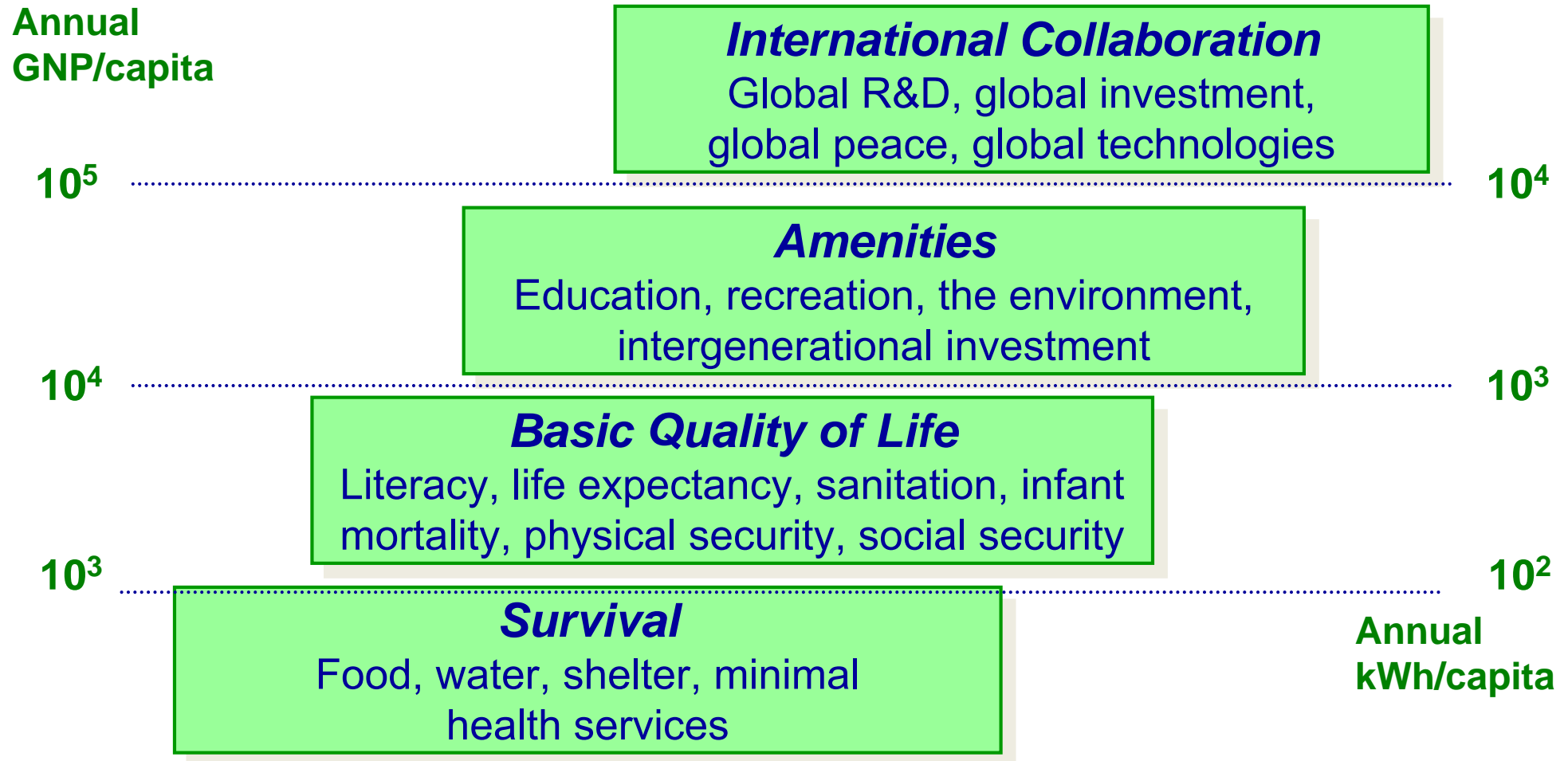
Figure 3. Per capita electricity consumption (kWh) versus GDP per capita purchasing power parity (PPP) of selected countries.³

GDP and Energy Consumption

GDP/capita



Social Conditions and Access to Electricity



Source: Dr. Chauncey Starr

A personal observation on electrification and societal transformation



My father Dr. Mohammad Shafi Amin at the Mayo Clinic (pictured in Lake City, Minnesota on January 2, 1952)



My Mom Mrs. Nahid Loghman Adham (passport picture to go to Sorbonne, May 1946)

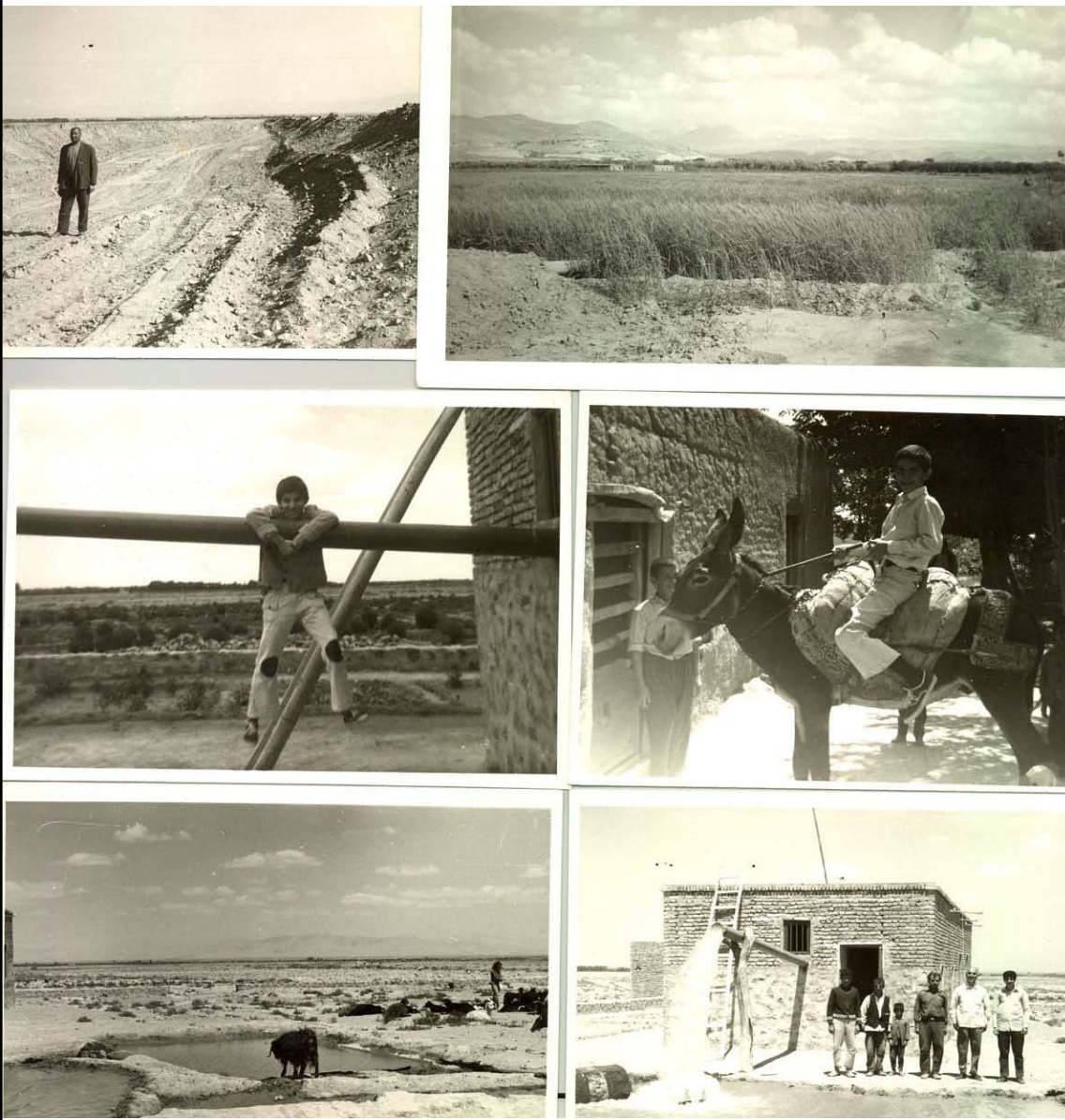


My Mom and me, Nov. 1961



Near Persepolis, Iran, age 7, March 1969

A personal observation on electrification and societal transformation

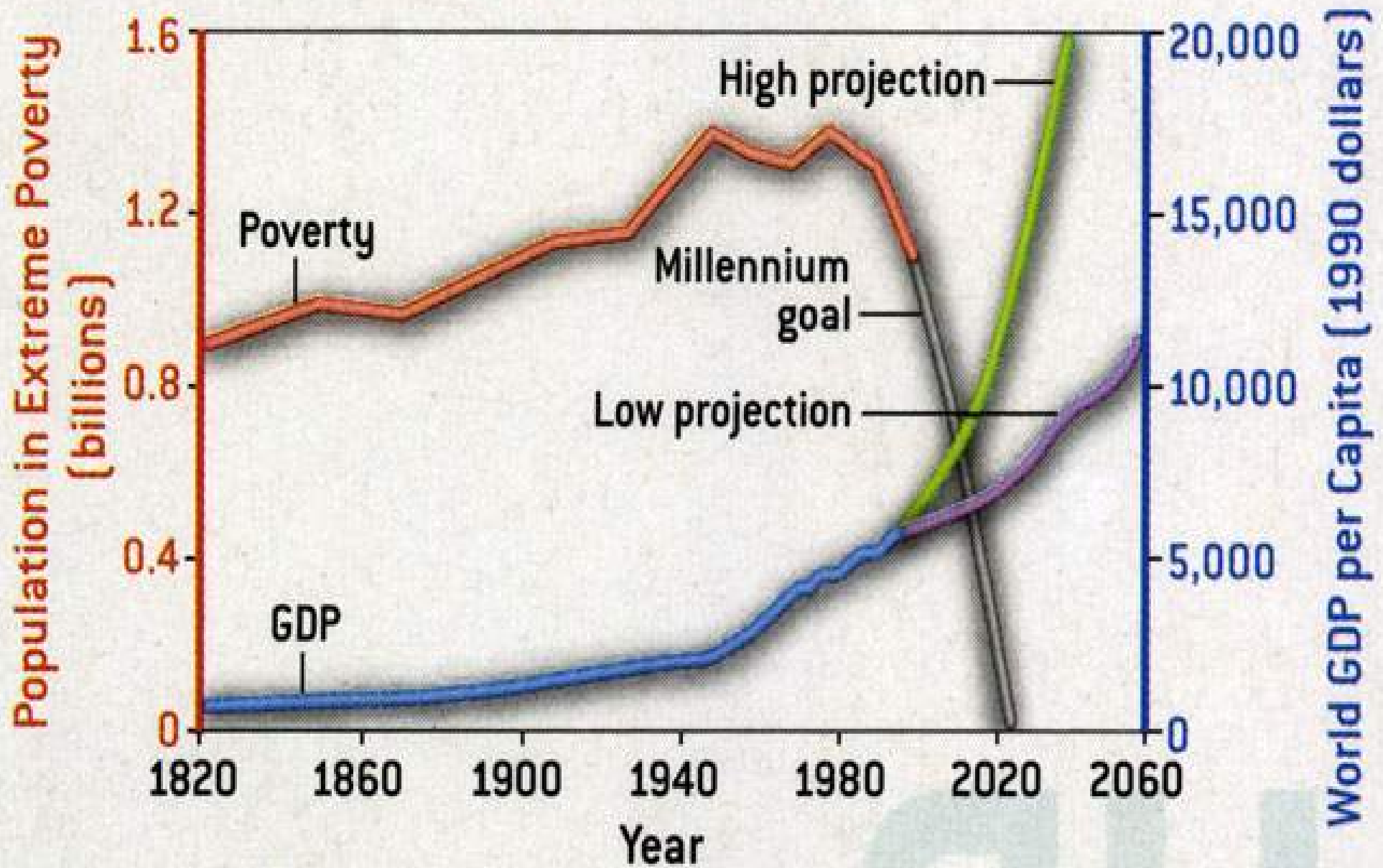


Rural electrification, age 11, June 1973

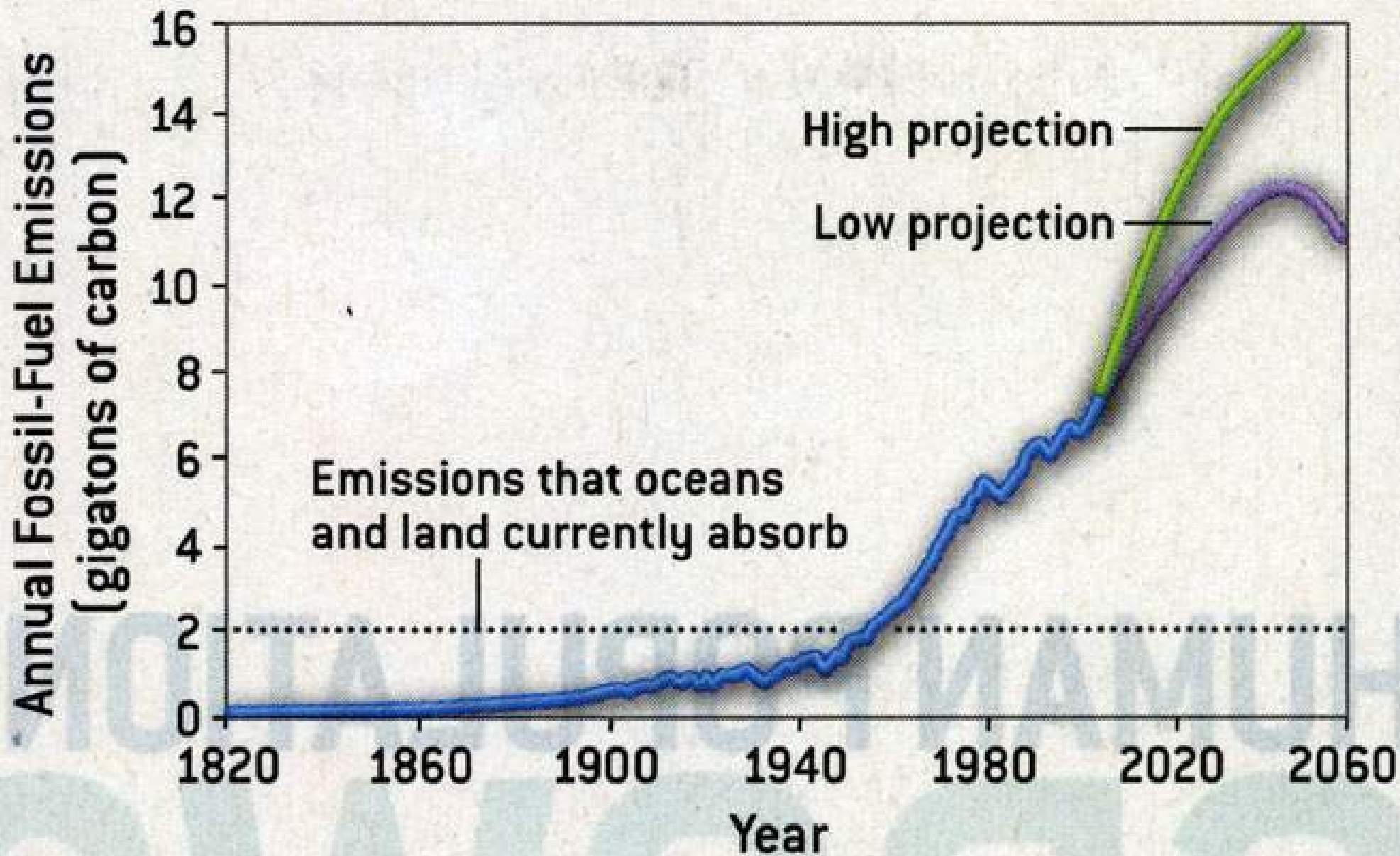


Minnesota, January 2005

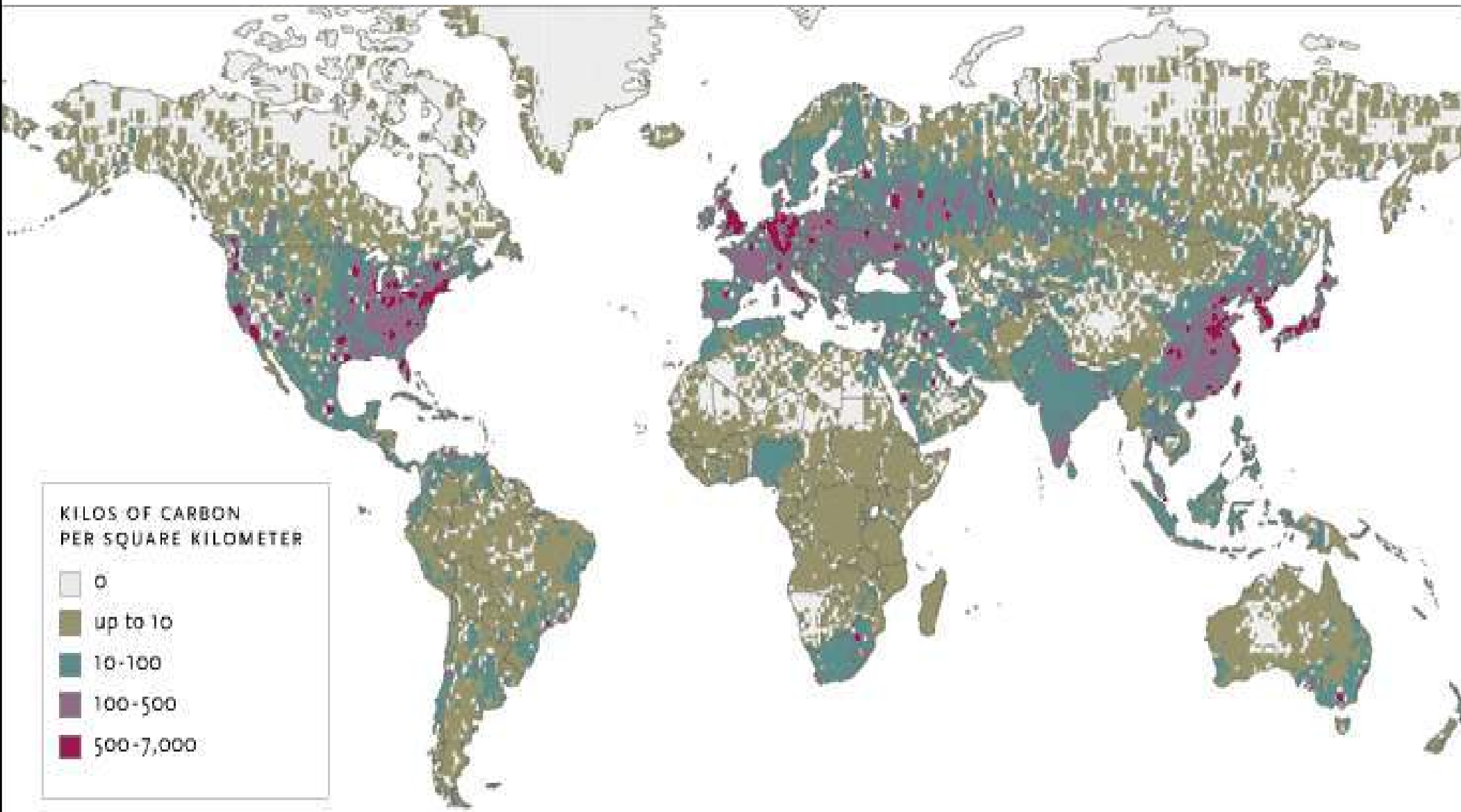
... PROSPERITY IS SPREADING ...



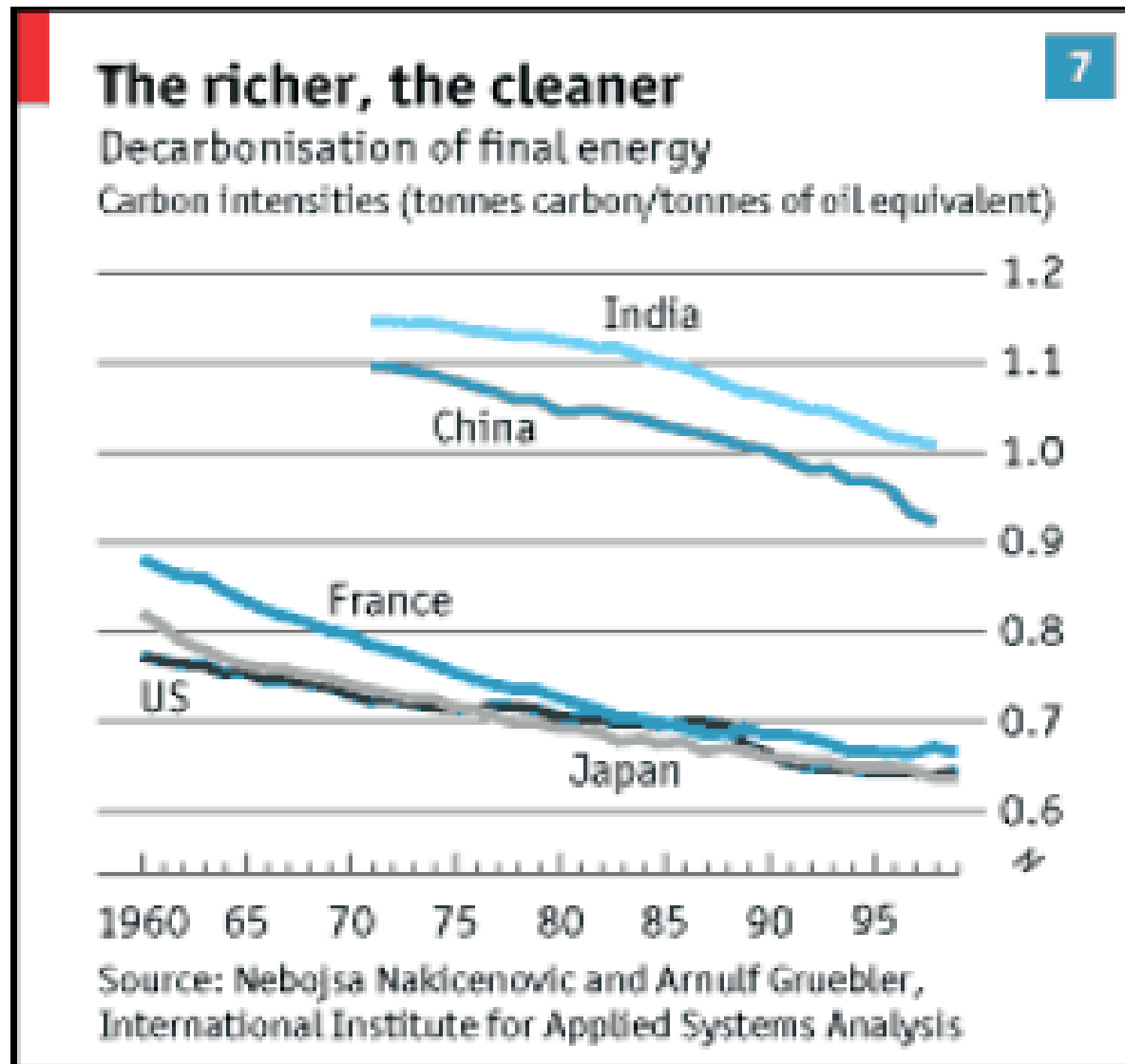
... BUT CO₂ EMISSIONS ARE TROUBLING



Context: Global Emissions



S&T for Sustainable Development

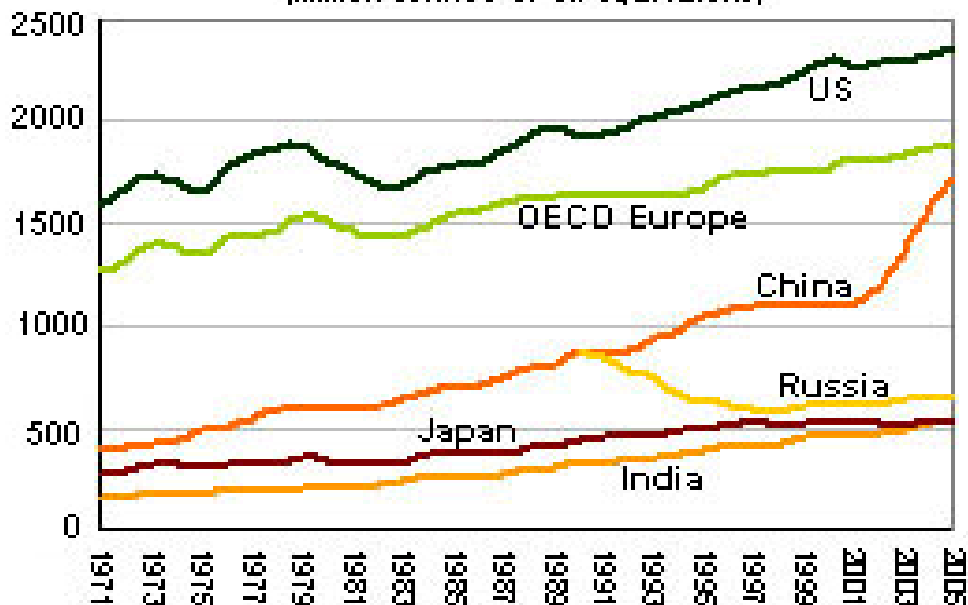


Source: RFF, 2002

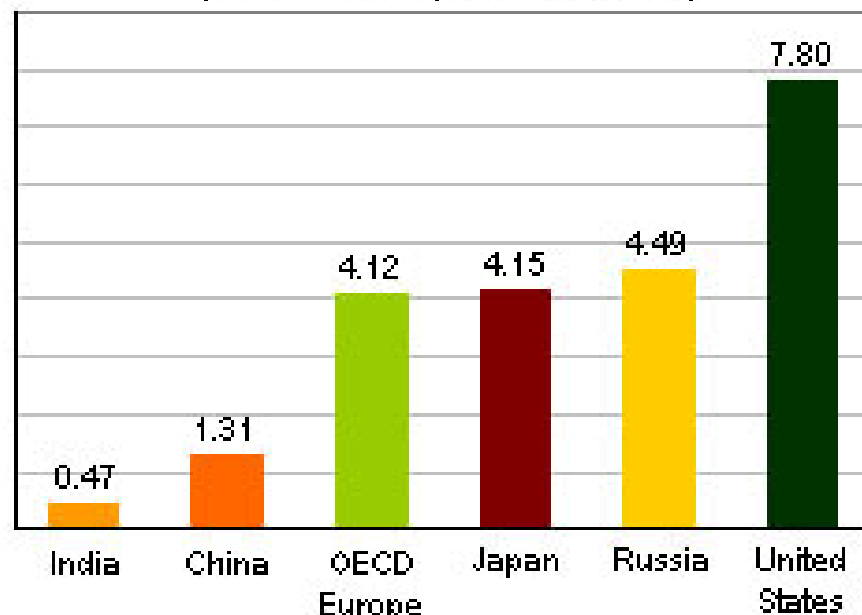
Energy Demand

Source: <http://earthtrends.wri.org/updates/node/274>

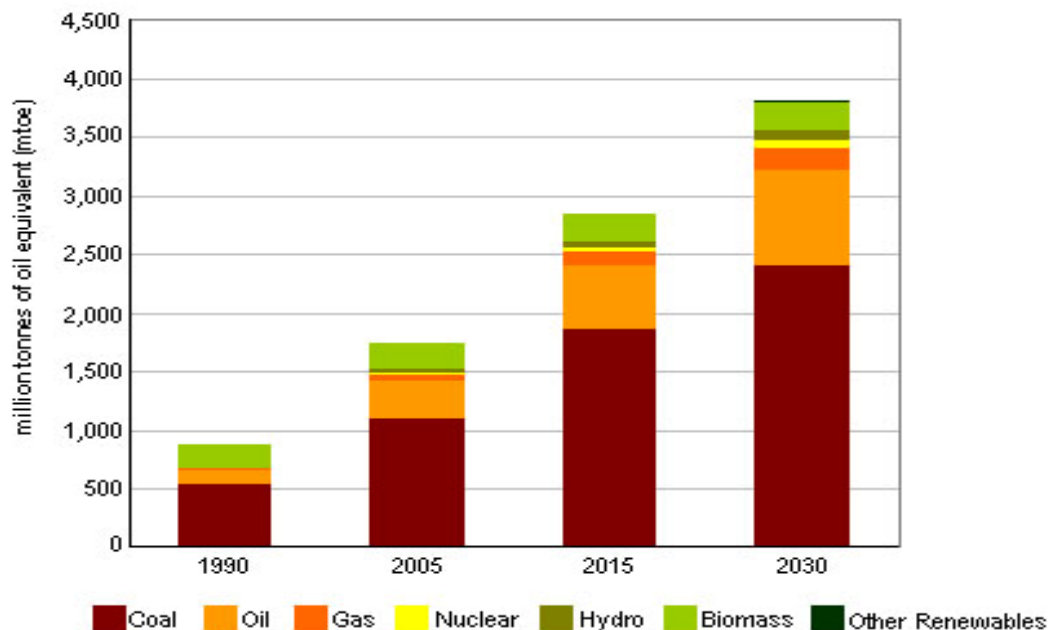
Total Energy Demand
(million tonnes of oil equivalent)



Per Capita Energy Demand
(tonnes of oil equivalent in 2005)

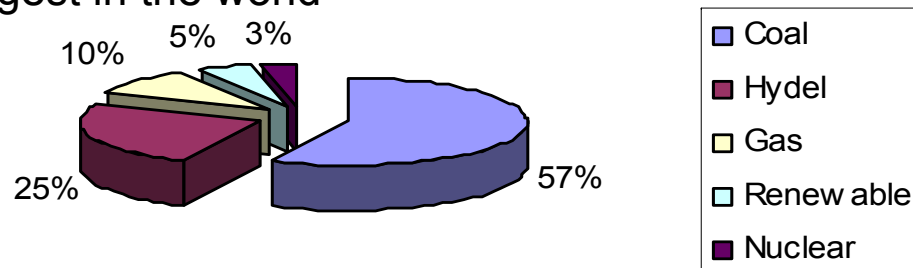


China's Energy Growth



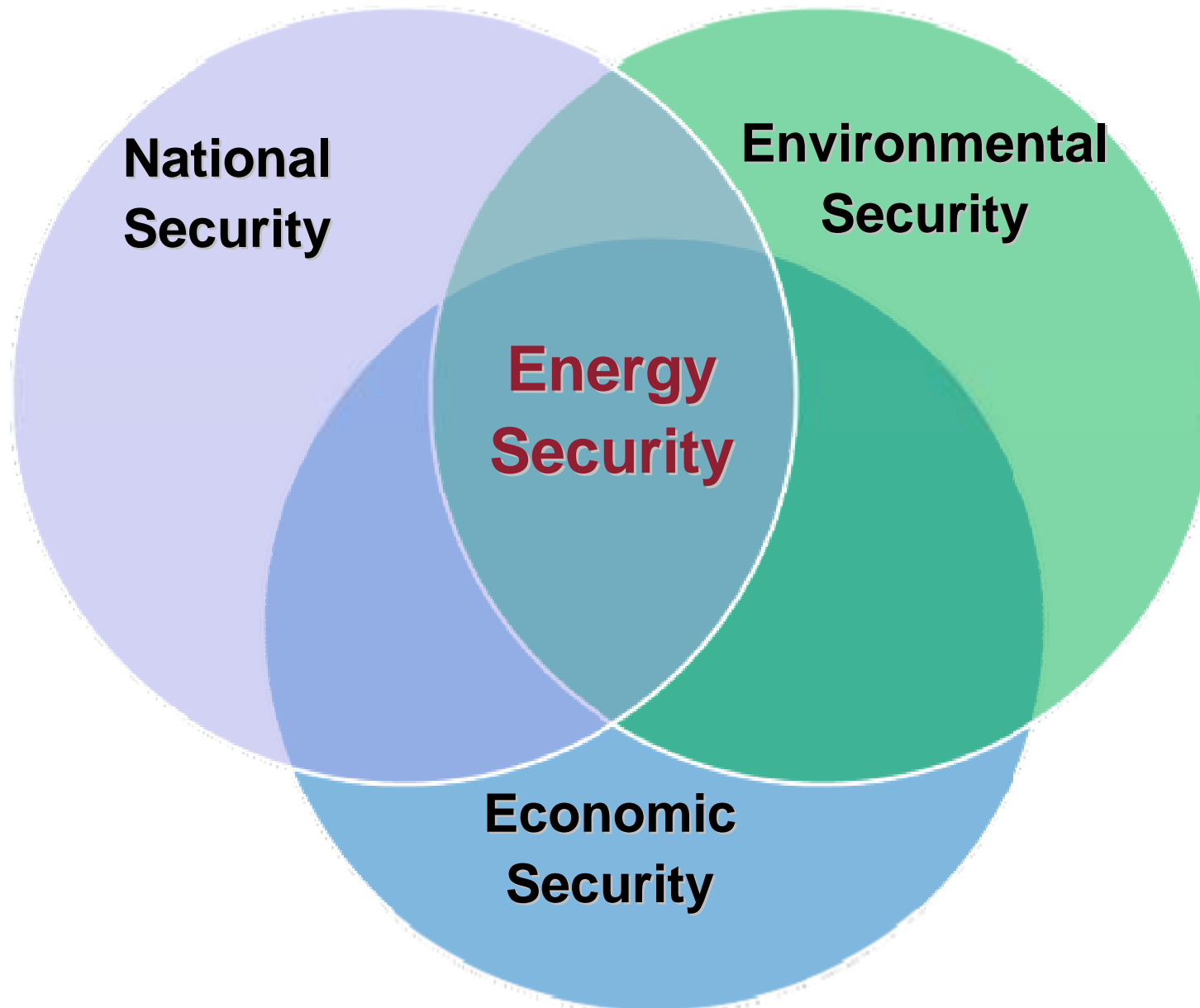
India's installed Capacity

122 GW; 5th largest generation capacity in world
T & D network of 5.7 million circuit km – 3rd largest in the world

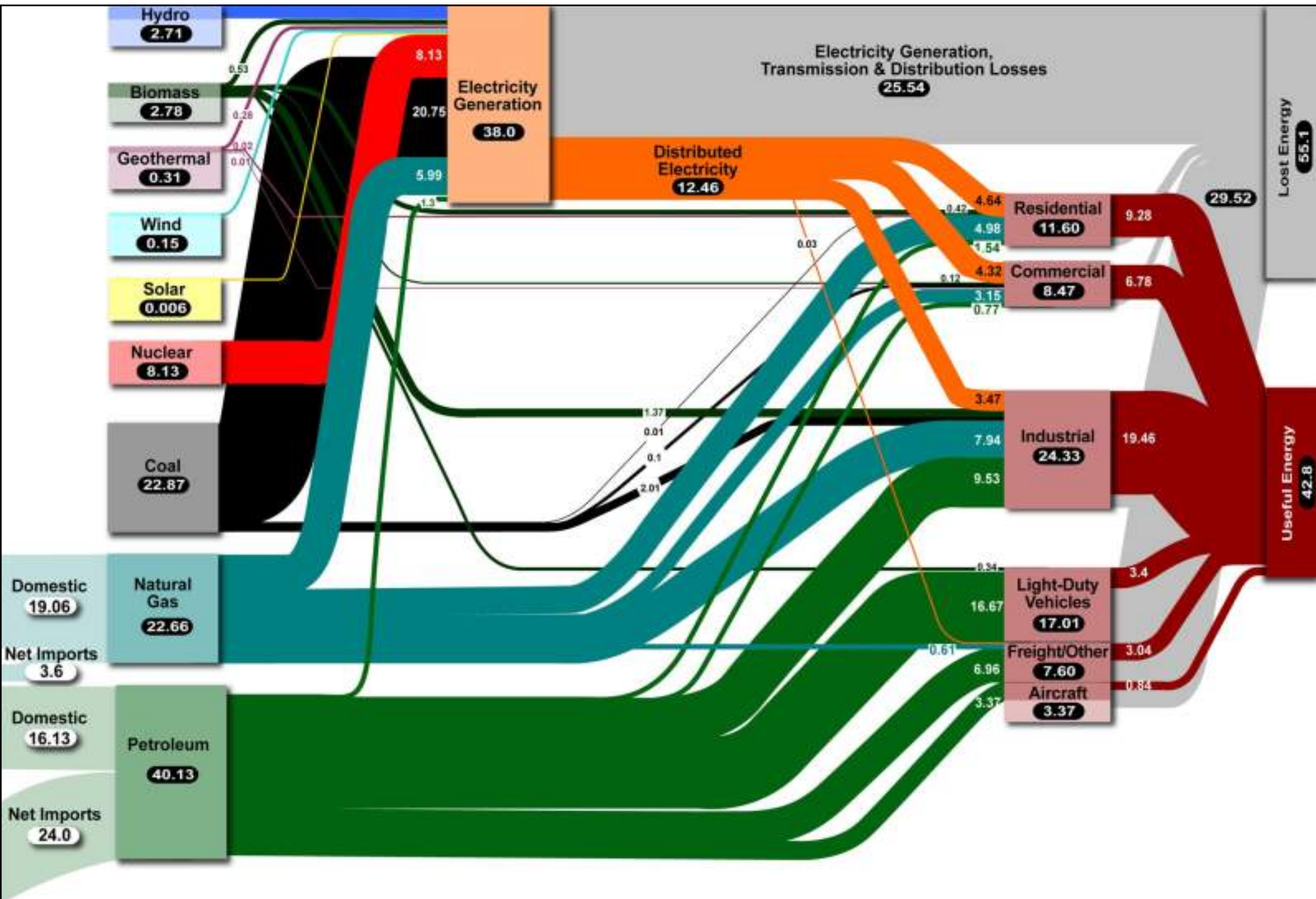


Low per capita consumption at 606 units -- less than half of China

The Energy Nexus: What we've learned from Energy Crises



Source: RAND



Energy map adapted from the U.S. DOE and LBNL

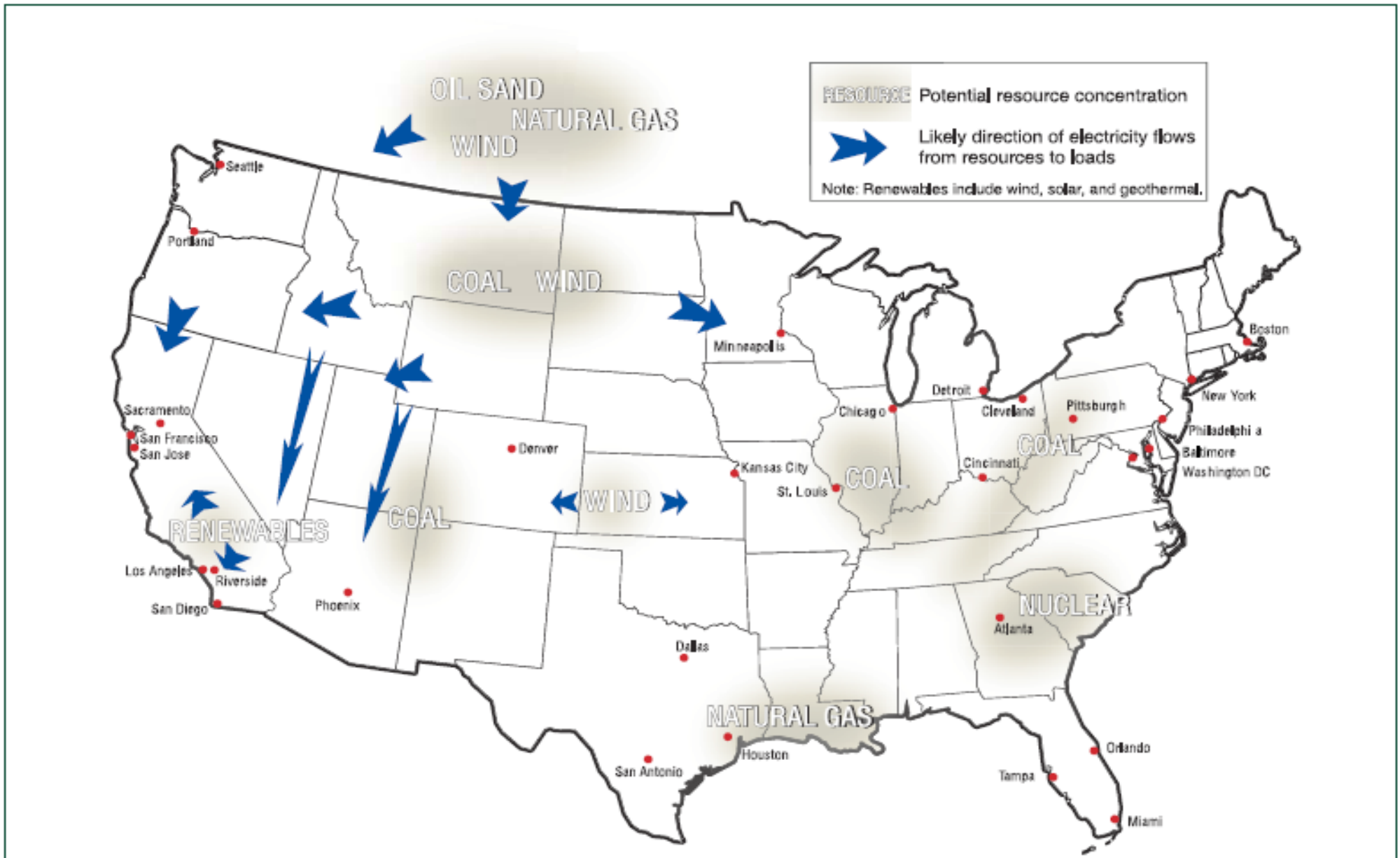
Goals and Recommendations

- **Building a stronger and smarter electrical energy infrastructure**
 - Transforming the Network into a Smart Grid
 - Developing an Expanded Transmission System
 - Developing Massive Electricity Storage Systems
- **Breaking our addiction to oil by transforming transportation**
 - Electrifying Transportation: Plug-In Hybrid Electric Vehicles
 - Developing and Using Alternative Transportation Fuels
- **Greening the electric power supply**
 - Expanding the Use of Renewable Electric Generation
 - Expanding Nuclear Power Generation
 - Capturing Carbon Emissions from Fossil Power Plants
- **Increasing energy efficiency**

Source: IEEE Energy Policy Committee, 2009

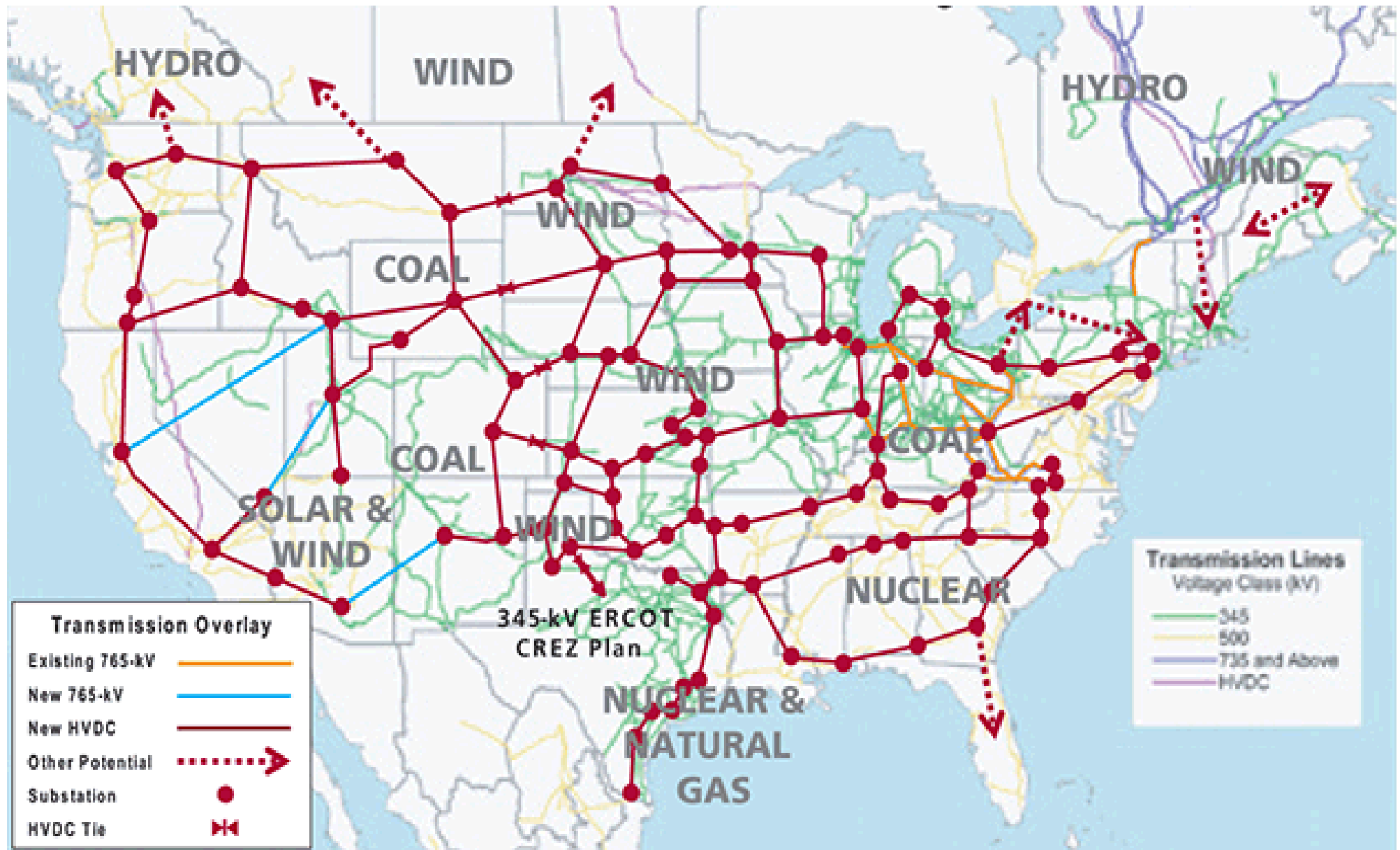


Context: New patterns in power delivery



Map adapted from the U.S. DOE National Electric Transmission Congestion Study

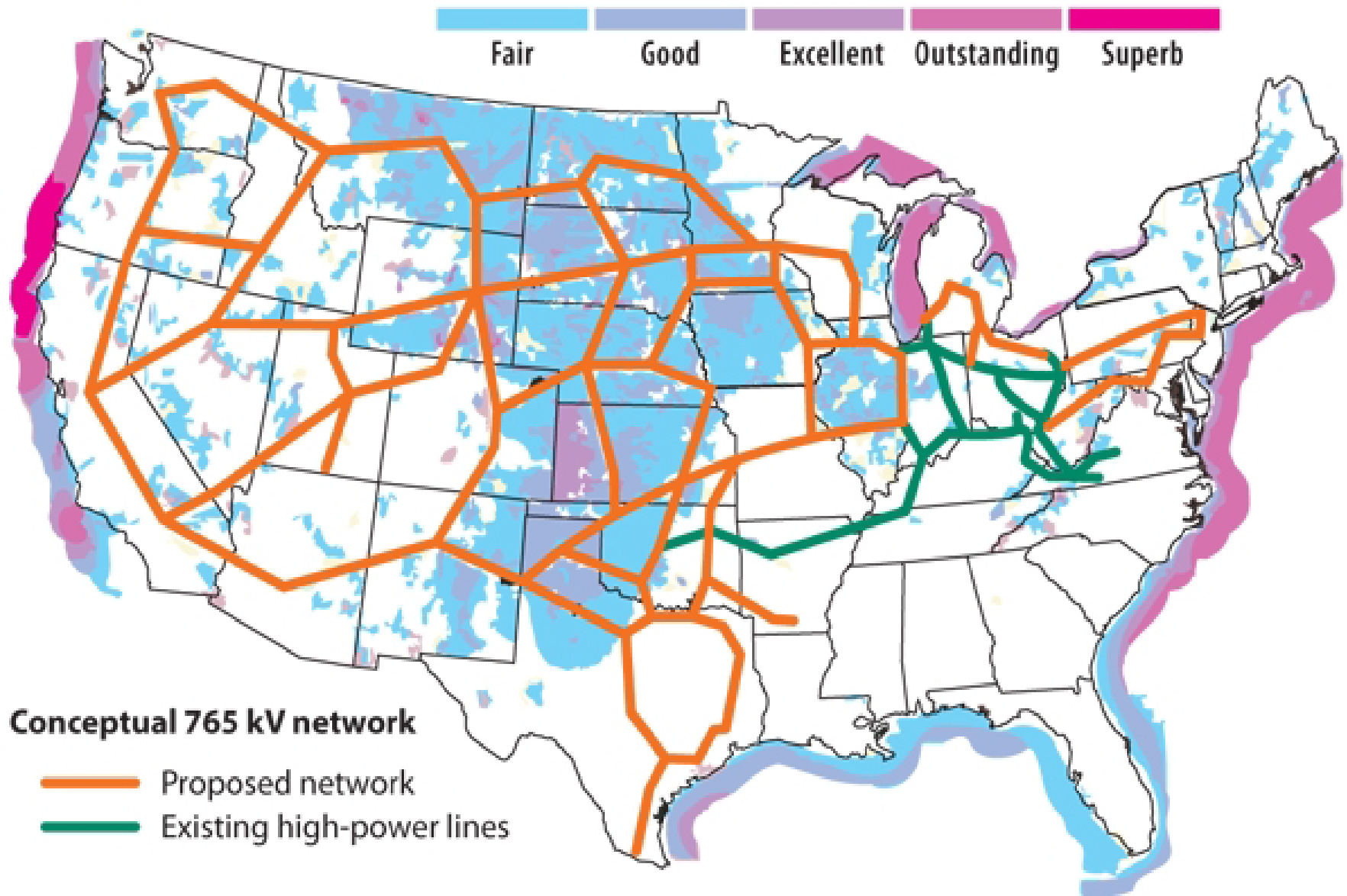
Enabling a Stronger Grid



Map adapted from the U.S. DOE National Electric Transmission Congestion Study

Example: American Electric Power (AEP) Corp.

765 kV PLAN



Source: US Department of Energy and American Electric Power

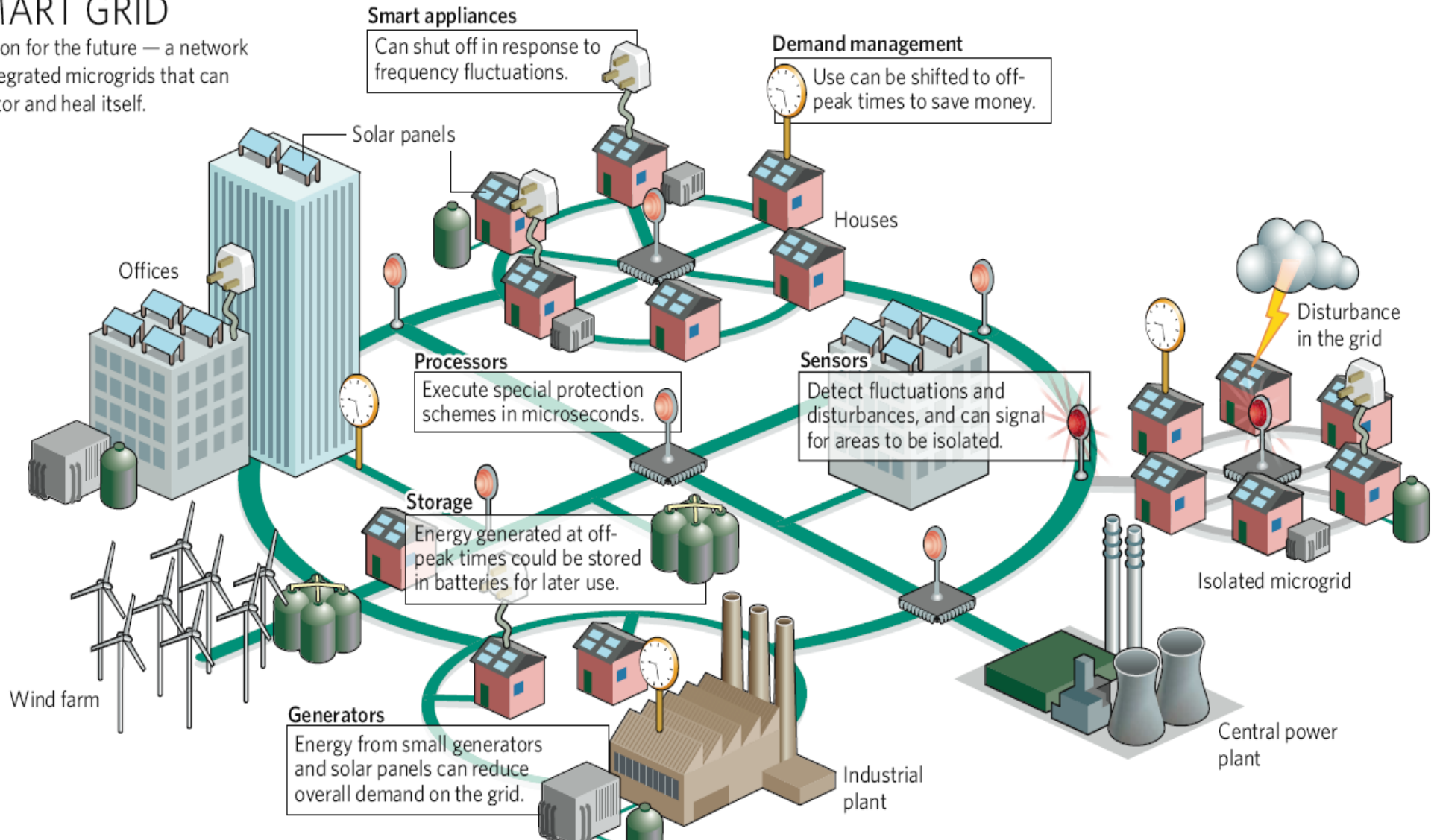
SCOTT WALLACE/STAFF

Our Goal: Enabling the Future

Infrastructure integration of microgrids, diverse generation and storage resources into a system of a smart self-healing grid

SMART GRID

A vision for the future — a network of integrated microgrids that can monitor and heal itself.



Source: Interview with Massoud Amin, "Upgrading the grid,"
Nature, vol. 454, pp. 570–573, 30 July 2008

Critical Tasks and Challenges

SMART GRID

A vision for the future — a network of smart appliances, smart meters, and smart devices that can communicate with each other and the grid.

Generation

Transmission

Distribution

Customers

Real-time Simulation and Contingency Analysis

Integration of Distributed Generation, Massive Storage and Alternate Energy Sources

Electrifying Transportation: Plug-In Hybrid Electric Vehicles and Integration

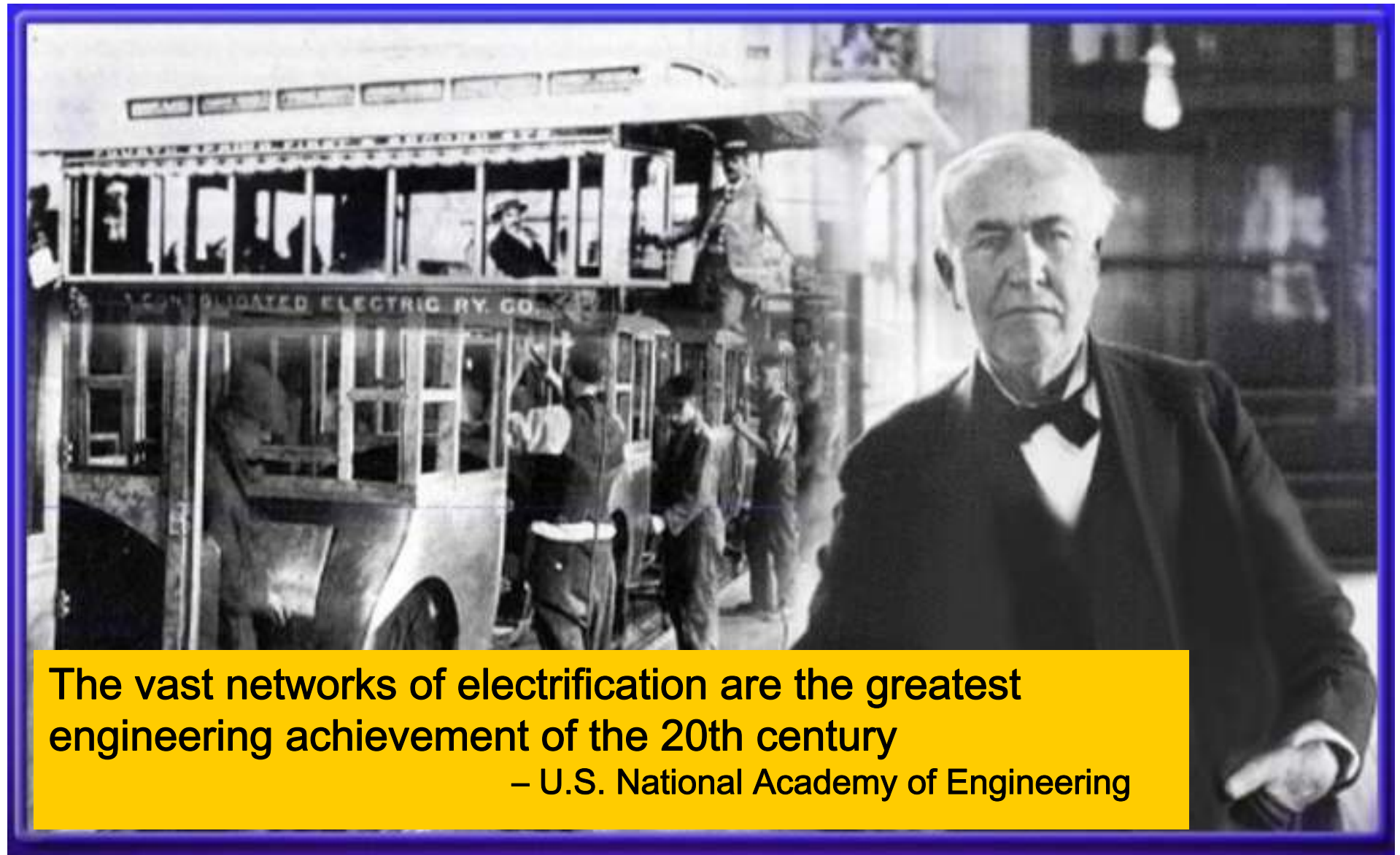
Self-Healing Wide-Area Protection and Islanding

Asset Management and On-Line Equipment Monitoring

Demand Response and Dynamic Pricing

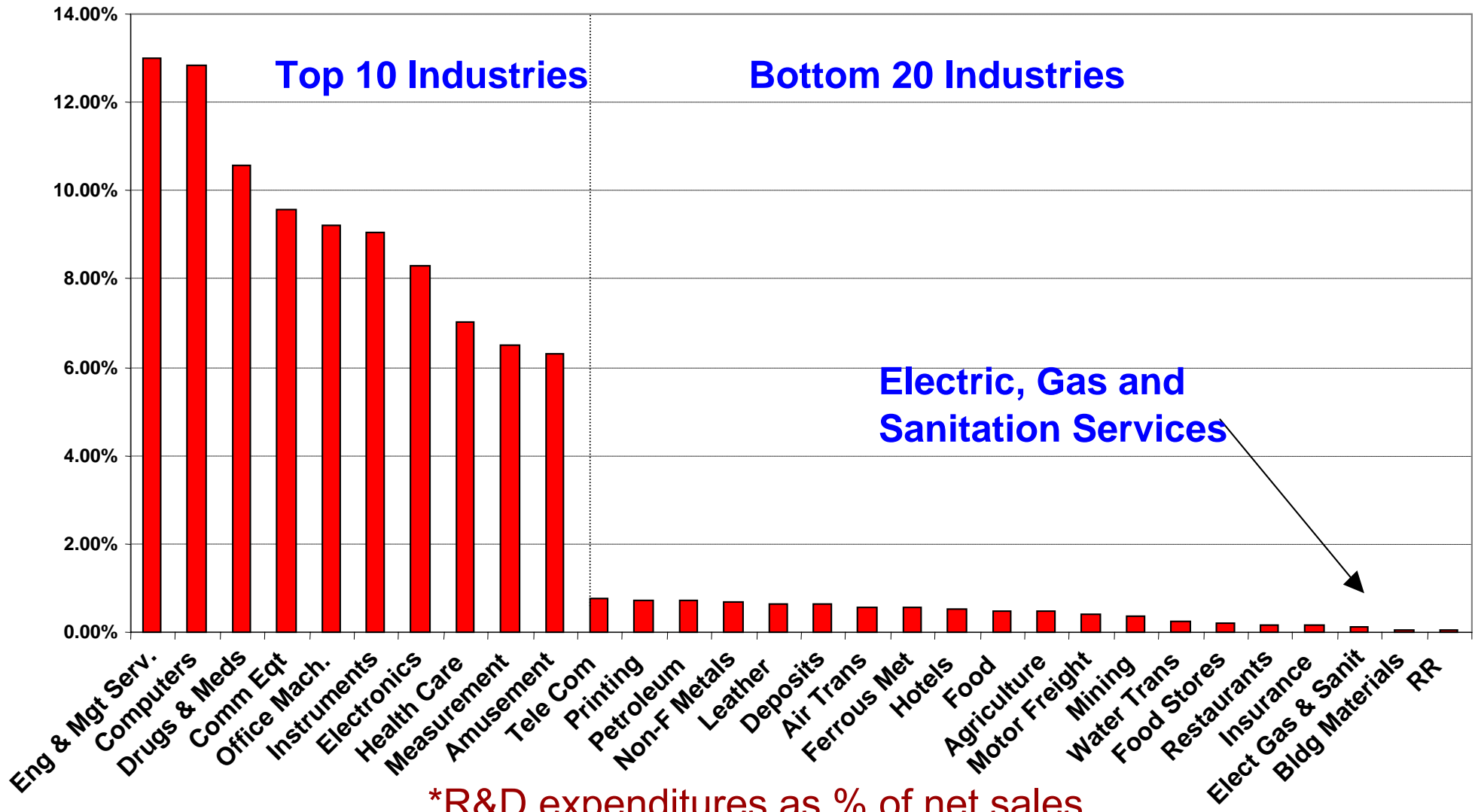
“Dollars and Watts” Participation in Energy Markets

Context: Transforming Society



The vast networks of electrification are the greatest engineering achievement of the 20th century
– U.S. National Academy of Engineering

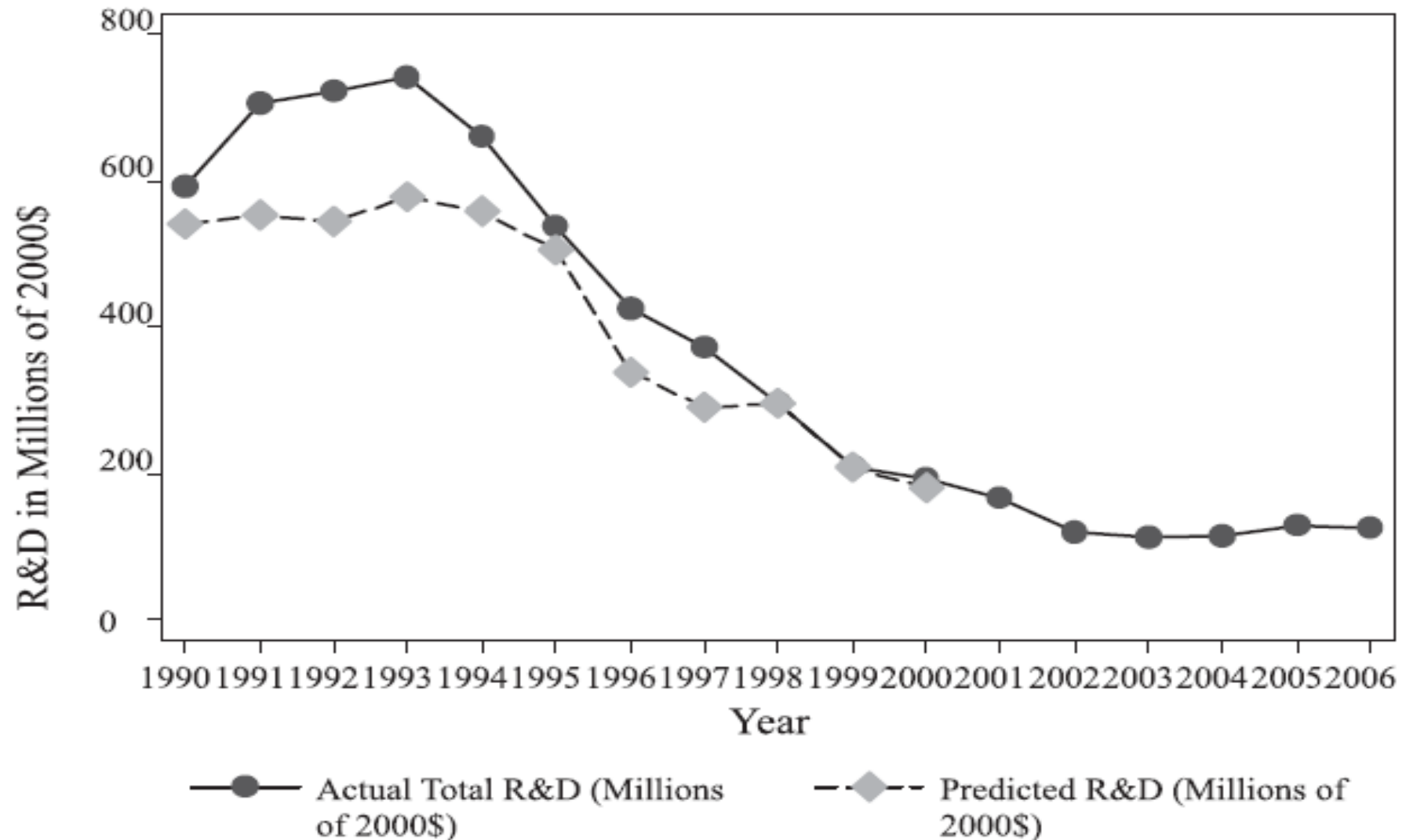
Context: R&D Expenditures*



*R&D expenditures as % of net sales

U.S. Electric Utilities R&D: 1990-2006

Annual R&D in the lowest rates of any major industrial sector with the exception of the pulp and paper

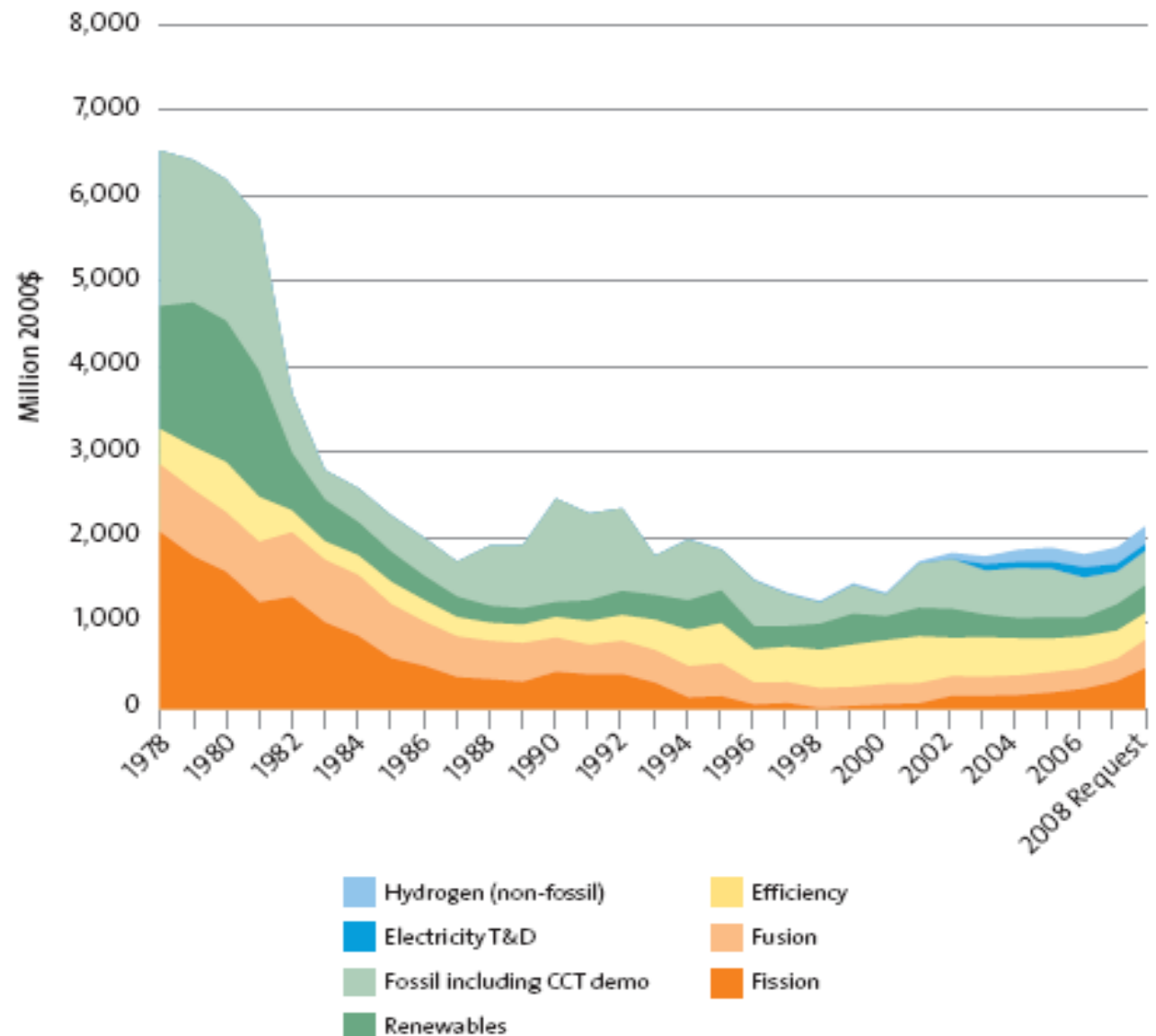


Source: "Powering Progress: Restructuring, Competition, and R&D in the U.S. Electric Utility Industry," by *Paroma Sanyal and Linda Cohen*, *The Energy Journal*, Vol. 30, No. 2, 2009

U.S. DOE ENERGY RD&D: Real Spending FY 1978–FY2008

•Analyses of DOE data shows that over the 25 years from FY 1978 to FY 2004, US government appropriations for ERD&D fell from 6.4B to \$2.75B in constant year-2000 dollars, a nearly 60% reduction.

•The part of these appropriations devoted to applied energy-technology RD&D fell from \$6.08 B to \$1.80B.



Source: Gallagher, K.S., A. Sagar, D. Segal, P. de Sa, and J.P. Holdren. 2007. DOE Budget Authority for Energy Research, Development and Demonstration Database. Energy Technology Innovation Project. John F. Kennedy School of Government, Harvard University.

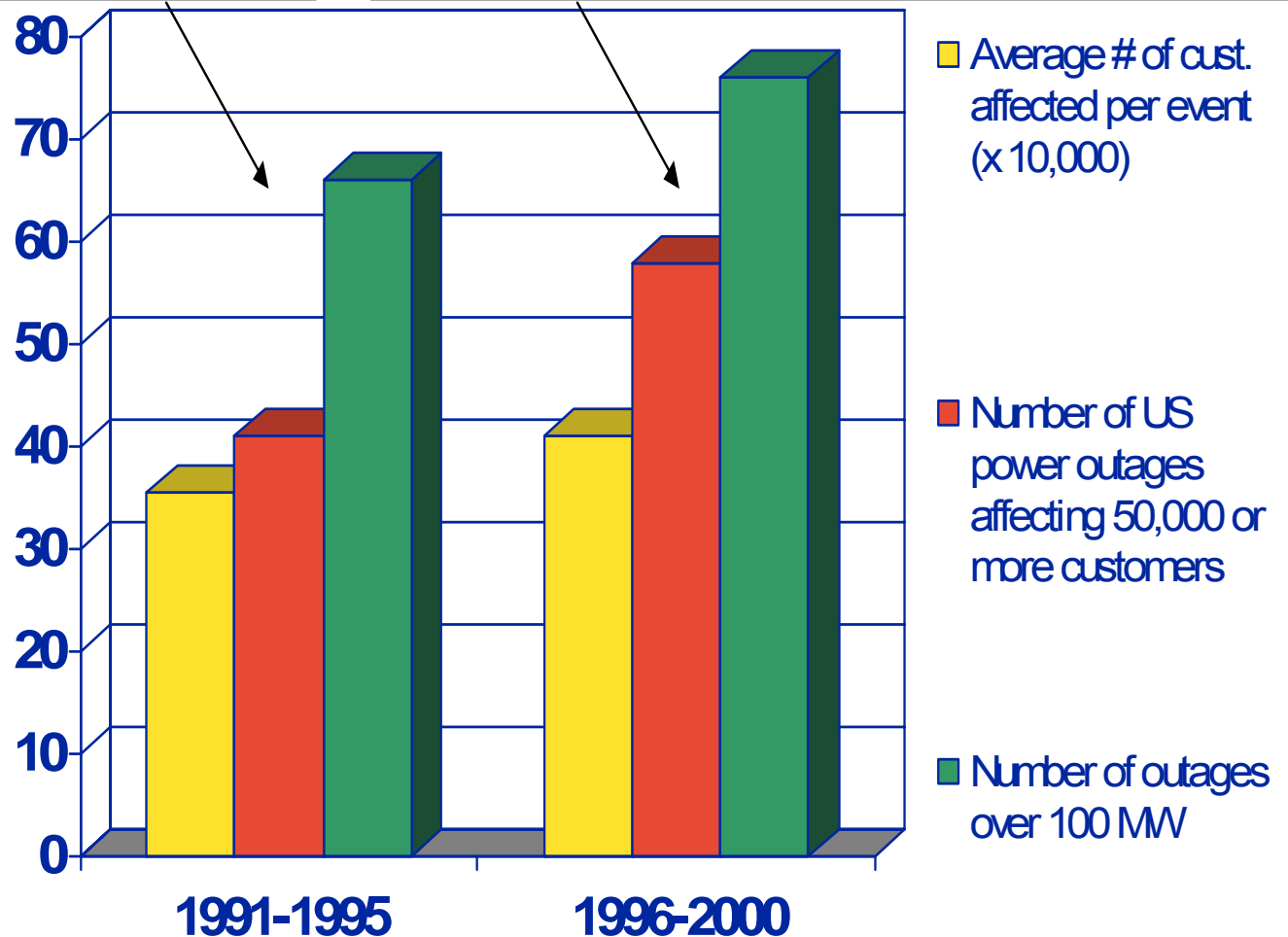
Historical Analysis of U.S. outages (1991-2000)

66 Occurrences over 100 MW
 798 Average MW Lost
 41 Occurrences over 50,000 Consumers
 355,204* Average Consumers Dropped

76 Occurrences over 100 MW
 1,067 Average MW Lost
 58 Occurrences over 50,000 Consumers
 409,854* Average Consumers Dropped

Increasing frequency and size of US power outages 100 MW or more (1991-1995 versus 1996-2000), affecting 50,000 or more consumers per event.

Data courtesy of NERC's Disturbance Analysis Working Group database



*Note: Annual increase in load (about 2%/year) and corresponding increase in consumers should be taken into account.

© 2009 No part of this presentation may be reproduced in any form without prior authorization.

Historical Analysis of U.S. outages (1991-2005)

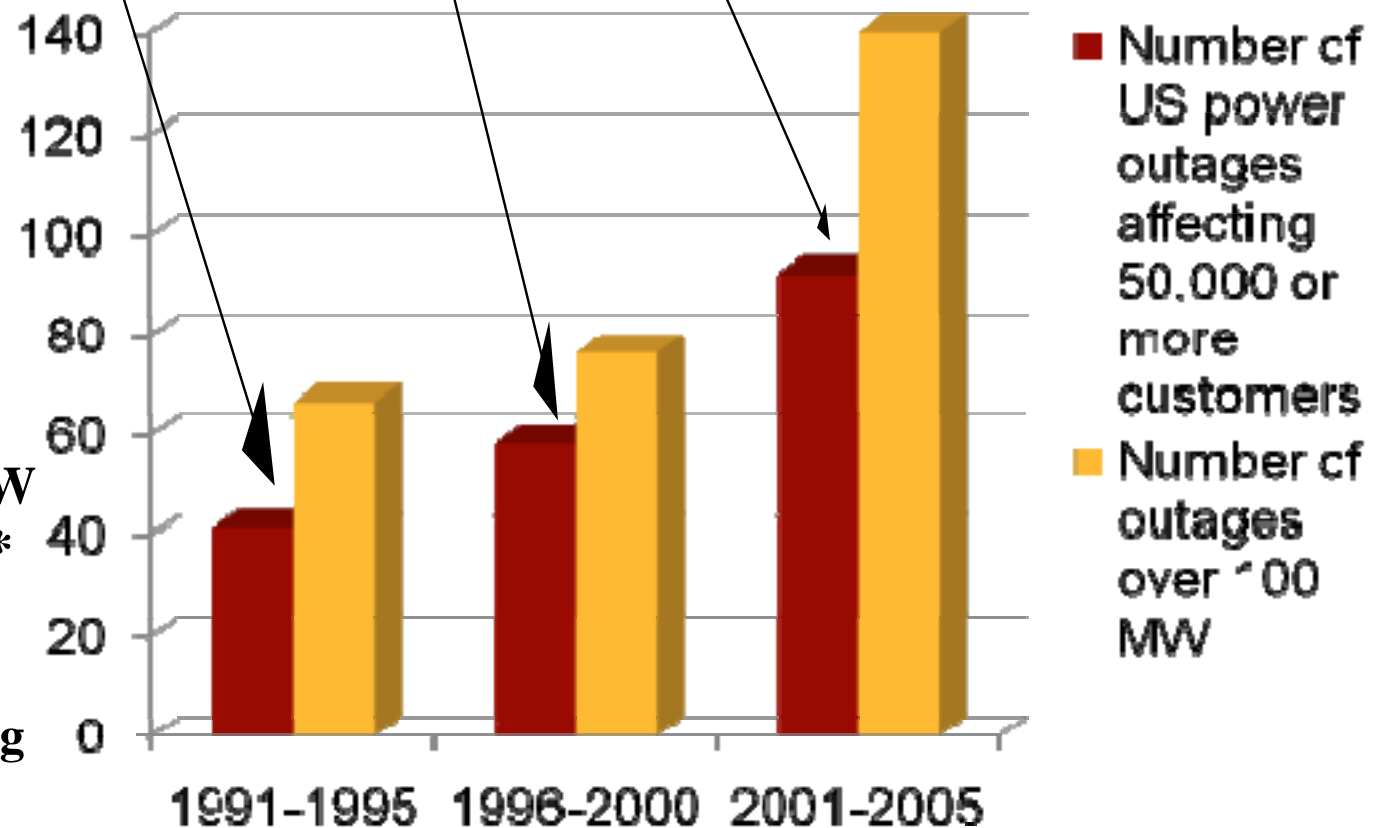
66 Occurrences over 100 MW
41 Occurrences over 50,000* Consumers

76 Occurrences over 100 MW
58 Occurrences over 50,000* Consumers

Result: Large blackouts are growing in number and severity.

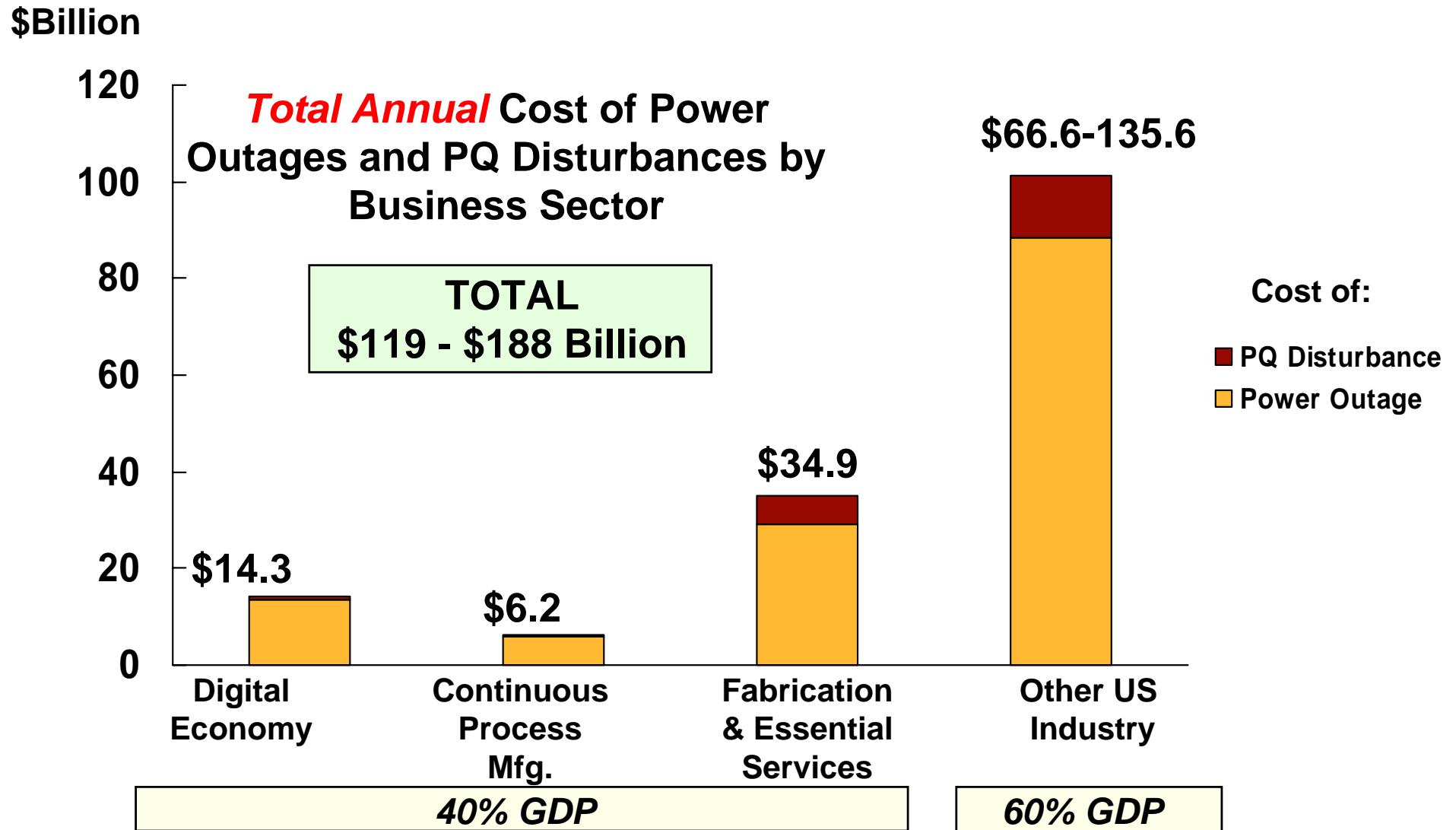
*Analyzing 2006 outages:
24 Occurrences over 100 MW
34 Occurrences over 50,000* or more Consumers
Data courtesy of NERC's Disturbance Analysis Working Group database

140 Occurrences over 100 MW
92 Occurrences over 50,000* Consumers



*Note: Annual increase in load (about 2%/year) and corresponding increase in consumers should be taken into account.

A Toll Felt Throughout the U.S. Economy: Over \$100B per year



Source: Primen Study: The Cost of Power Disturbances to Industrial & Digital Economy Companies

Context: Transmission investment in the United States and in international competitive markets

Country	Investment in High Voltage Transmission (>230 kV) Normalized by Load for 2004–2008 (in US\$/MW/year)	Number of Transmission-Owning Entities
New Zealand	22.0	1
England & Wales (NGT)	16.5	1
Denmark	12.5	2
Spain	12.3	1
The Netherlands	12.0	1
Norway	9.2	1
Poland	8.6	1
Finland	7.2	1
United States	4.6	450
	(based on representative data from EEI)	(69 in EEI)

Source: IEEE PES, 2006

Infrastructure and R&D Investments

- **Industry: U.S. Electric Utilities R&D (1990- 2008):**
 - Annual R&D in the lowest rates of any major industrial sector with the exception of the pulp and paper
- **Government: U.S. DOE Energy RD&D real spending (FY 1978–FY2008):**
 - Analyses of DOE data shows that over the 25 years from FY 1978 to FY 2004, US government appropriations for ERD&D fell from 6.4B to \$2.75B in constant year-2000 dollars, a nearly 60% reduction
 - The part of these appropriations devoted to applied energy-technology RD&D fell from \$6.08 B to \$1.80B
- **Systematic underinvestment in R&D for the electric power systems**
 - Various attempts in regulatory proceedings to encourage or establish higher levels of R&D investments
 - The results from such efforts have been mixed. Some funds used for economic development activities or **local demonstrations of already commercially available technology, which do little to evolve the innovations in science and technology that are needed**
 - Collaborative programs have had more success in this regard; however, states have difficulty in funding any research outside of their state
 - Motivation among state regulators to encourage higher levels of R&D for the utilities is tempered by the difficulty of providing strong business cases for R&D—which by its nature is inherently uncertain. **These investments also require patience for longer-term paybacks.**
- **U.S. outages (1984-2008) with increasing frequency, severity, and costs of over \$80B/year.**

Sources: 1) EPRI and EEI,

2) Gallagher, K.S., A. Sagar, D. Segal, P. de Sa, and J.P. Holdren. 2007. DOE Budget Authority for Energy Research, Development and Demonstration Database. Energy Technology Innovation Project. John F. Kennedy School of Government, Harvard University, and

3) "Powering Progress: Restructuring, Competition, and R&D in the U.S. Electric Utility Industry," by Paroma Sanyal and Linda Cohen, *The Energy Journal*, Vol. 30, No. 2, 2009

© 2009 No part of this presentation may be reproduced in any form without prior authorization.



A “Problem that Matters” in the 21st Century

Will today’s electricity supply system be left behind as an industrial relic of the 20th century, or become the critical infrastructure supporting the digital society, a smart self-healing grid?

By 2020, more than 30 mega-cities in the now less-developed world.
By 2050, nearly 60 such cities



and rewarded on the value their thoughts bring to humanity. Knowledge workers in a corporation may outsize the corporation itself. Change is accelerating beyond the fundamental ability of organizations to anticipate it. The time to act is when the need and opportunity first become apparent. Acting on inklings becomes a key to surviving the speed of change. Waiting for management to take the lead is a fatal level of inaction. The arrival of a competitor's new product will be marked by the rule of three prevailing: The percentage of business available in pure competition is shrinking in many industries. The flow of goods and services in many markets in the developed world is made more fluid and free for international trade. Value has migrated to the experience and away from the product. Customers don't like clutter or visible complexity. There are global, cost-dominated competitors accessible. Overcapacity, too much competition, and no pricing power describe most product differentiation has powered brand dominance. Organizational skills, your networks, and your awareness of what comes with empowered and learner organizations. The new

What are we doing about it?

Overview of my research areas (1998-2003):

Initiatives and Programs I developed and/or led at EPRI

1999-2001

EPRI/DoD Complex Interactive Networks (CIN/SI)

Underpinnings of Interdependent Critical National Infrastructures
Tools that enable secure, robust & reliable operation of interdependent infrastructures with distributed intelligence & self-healing

Y2K2000-present

Enterprise Information Security (EIS)

1. Information Sharing
2. Intrusion/Tamper Detection
3. Comm. Protocol Security
4. Risk Mgmt. Enhancement
5. High Speed Encryption

2002-present

Infrastructure Security Initiative (ISI)

- Response to 9/11 Tragedies**
1. Strategic Spare Parts Inventory
 2. Vulnerability Assessments
 3. Red Teaming
 4. Secure Communications

2001-present

Consortium for Electric Infrastructure to Support a Digital Society (CEIDS)

1. Self Healing Grid
2. IntelliGrid™
3. Integrated Electric Communications System Architecture
4. Fast Simulation and Modeling

Background: EPRI/DOD Complex Interactive Network/Systems Initiative (1998-2002)

Complex interactive networks:

- **Energy infrastructure:** Electric power grids, water, oil and gas pipelines
- **Telecommunications:** Information, communications and satellite networks; sensor and measurement systems and other continuous information flow systems
- **Transportation and distribution networks**
- **Energy markets, banking and finance**



Develop tools that enable secure, robust and reliable operation of interdependent infrastructures with distributed intelligence and self-healing abilities

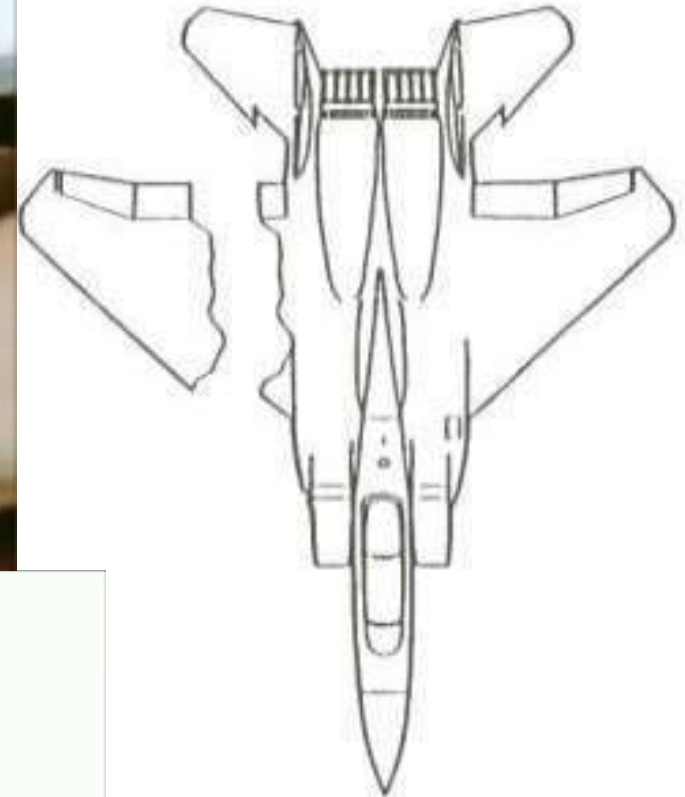
CIN/SI Funded Consortia

108 professors and over 240 graduate students in 28 U.S. universities were funded: Over 420 publications, and 24 technologies extracted, in the 3-year initiative

- U Washington, Arizona St., Iowa St., VPI
- Purdue, U Tennessee, Fisk U, TVA, ComEd/Exelon
- Harvard, UMass, Boston, MIT, Washington U.
- Cornell, UC-Berkeley, GWU, Illinois, Washington St., Wisconsin
- CMU, RPI, UTAM, Minnesota, Illinois
- Cal Tech, MIT, Illinois, UC-SB, UCLA, Stanford
- Defense Against Catastrophic Failures, Vulnerability Assessment
- Intelligent Management of the Power Grid
- Modeling and Diagnosis Methods
- Minimizing Failures While Maintaining Efficiency / Stochastic Analysis of Network Performance
- Context Dependent Network Agents
- Mathematical Foundations: Efficiency & Robustness of Distributed Systems

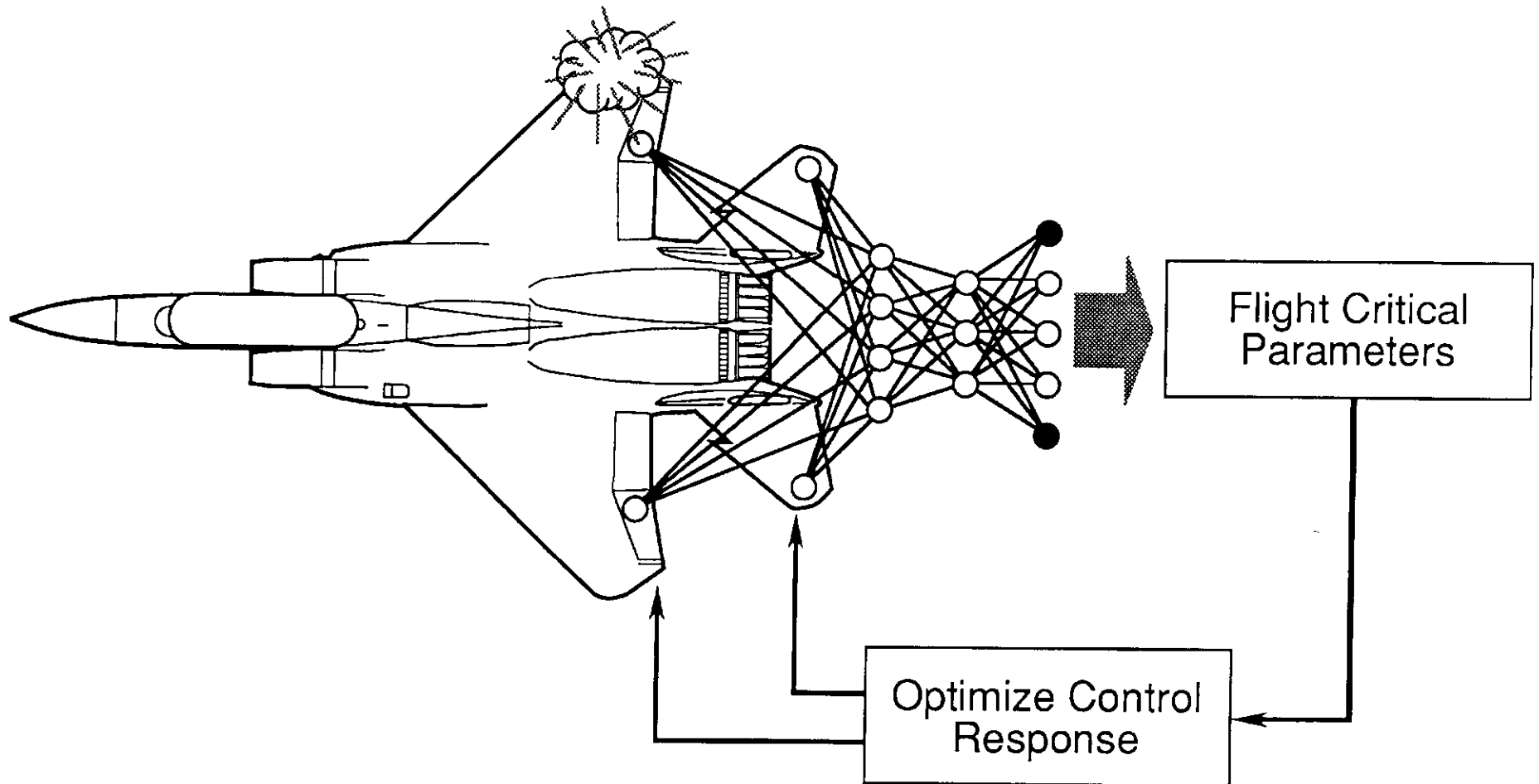


Foresight and Adaptation: Saving systems from collapse in multi-hazard environments: The Case of the Missing Wing (1983-97)



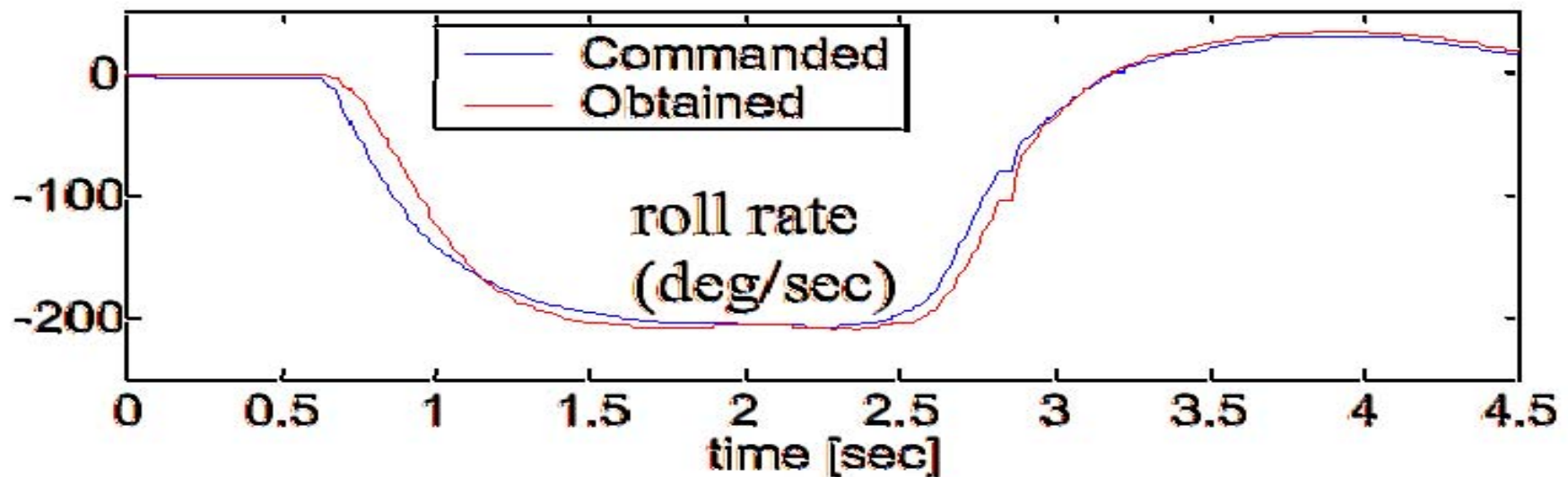
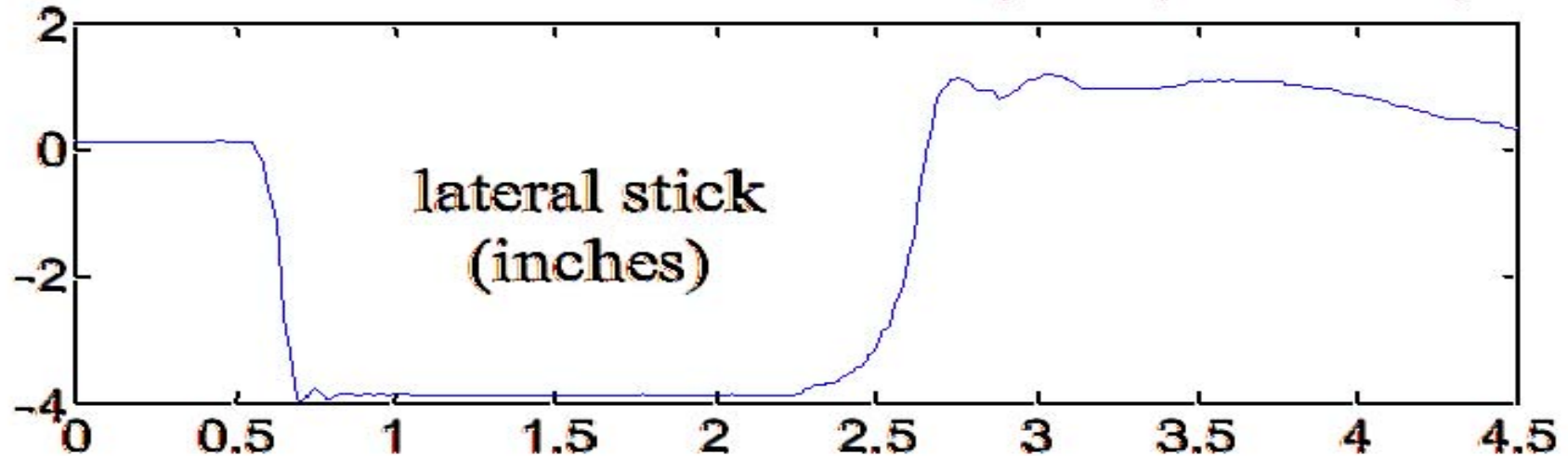
NASA/MDA/WU IFCS: NASA Ames Research Center, NASA Dryden, Boeing Phantom Works, and Washington University in St. Louis.

Goal: Optimize controls to compensate for damage or failure conditions of the aircraft



Intelligent Flight Control System: Example – complete hydraulic failure (1997)

IFCS DAG 0 full lateral stick roll at 20,000 ft, 0.75 Mach, Flt 126



Background: Sensing, modeling, simulation and control of complex systems in multi-hazard environments

My areas of R&D: Aug. 1983- Dec. 1997

- Control of helicopters subject to disturbances and uncertainties (1983-1985)
- Flight & Fire Control System with Rockwell Int'l tested in Germany by Messerschmidt and adapted as the pilot's assistant for the Advanced Euro Fighter (1987-1990)
- Evasive maneuvering against multiple pursuers with countermeasures (1990-1993)
- Real-time system identification, disturbance rejection and optimal control (1992-1998):
 - Control of a damaged F-15 (with McDonnell Douglas and NASA; 1995-1996)
 - Parameter est. and control of antiskid braking system for an MD-90 (1997-98)
 - Improved models and controls for crystal growth (with MEMC, 1993-95)
- Modeling, simulation and optimization of DoD's large-scale air transport operations; Mobility Analysis Support System (USAF's Air Mobility Command and the US Transportation Command; 1992-1997)
- IVHS/ITS: Urban traffic monitoring, prediction, and management (with SEI, 1993-1998)

Definition: **Self-Healing (“Smart”) Grid** (1998-present)

- **What is “self healing”?**
 - A system that uses information, sensing, control and communication technologies to allow it to deal with unforeseen events and minimize their adverse impact
- **Why is self healing concept important to the Electric Power Grid and Energy Infrastructure?**
 - A secure “architected” sensing, communications, automation (control), and energy overlaid infrastructure as an integrated, reconfigurable, and electronically controlled system that will offer unprecedented flexibility and functionality, and improve system availability, security, quality, resilience and robustness.

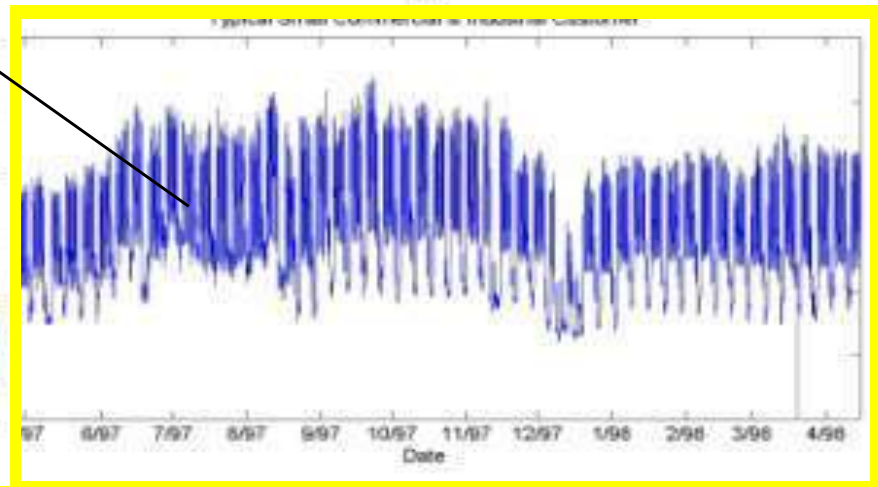
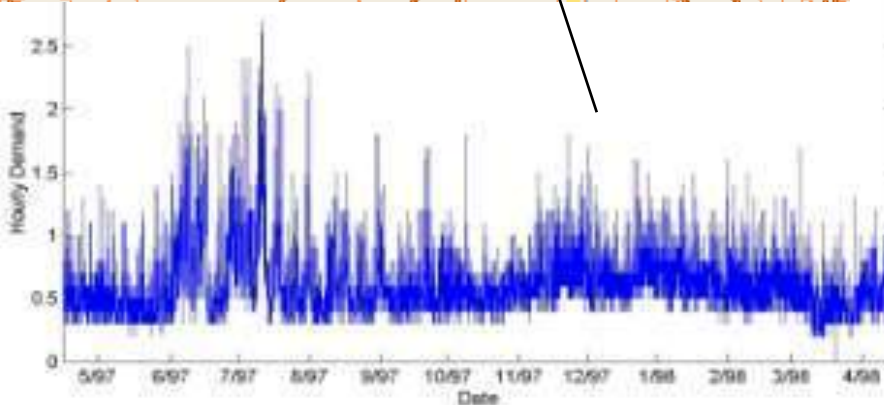
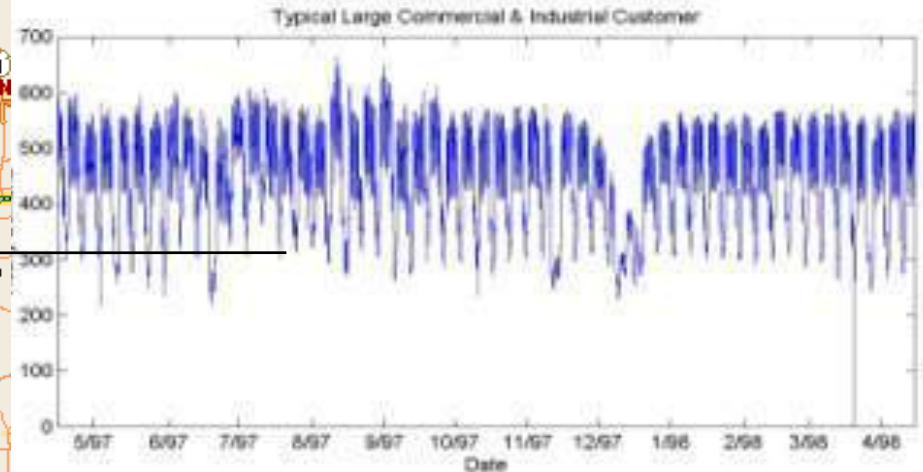
Critical System Dynamics and Capabilities

- **Anticipation of disruptive events**
- **Look-ahead simulation capability**
- **Fast isolation and sectionalization**
- **Adaptive islanding**
- **Self-healing and restoration**

re·sil·ience, *noun*, 1824:
The capability of a strained body to recover its size and shape after deformation caused especially by compressive stress;
An ability to recover from or adjust easily to misfortune or change

Resilience enables “Robustness”: A system, organism or design may be said to be "robust" if it is capable of coping well with variations (internal or external and sometimes unpredictable) in its operating environment with minimal damage, alteration or loss of functionality.

Local area grids (LAG)

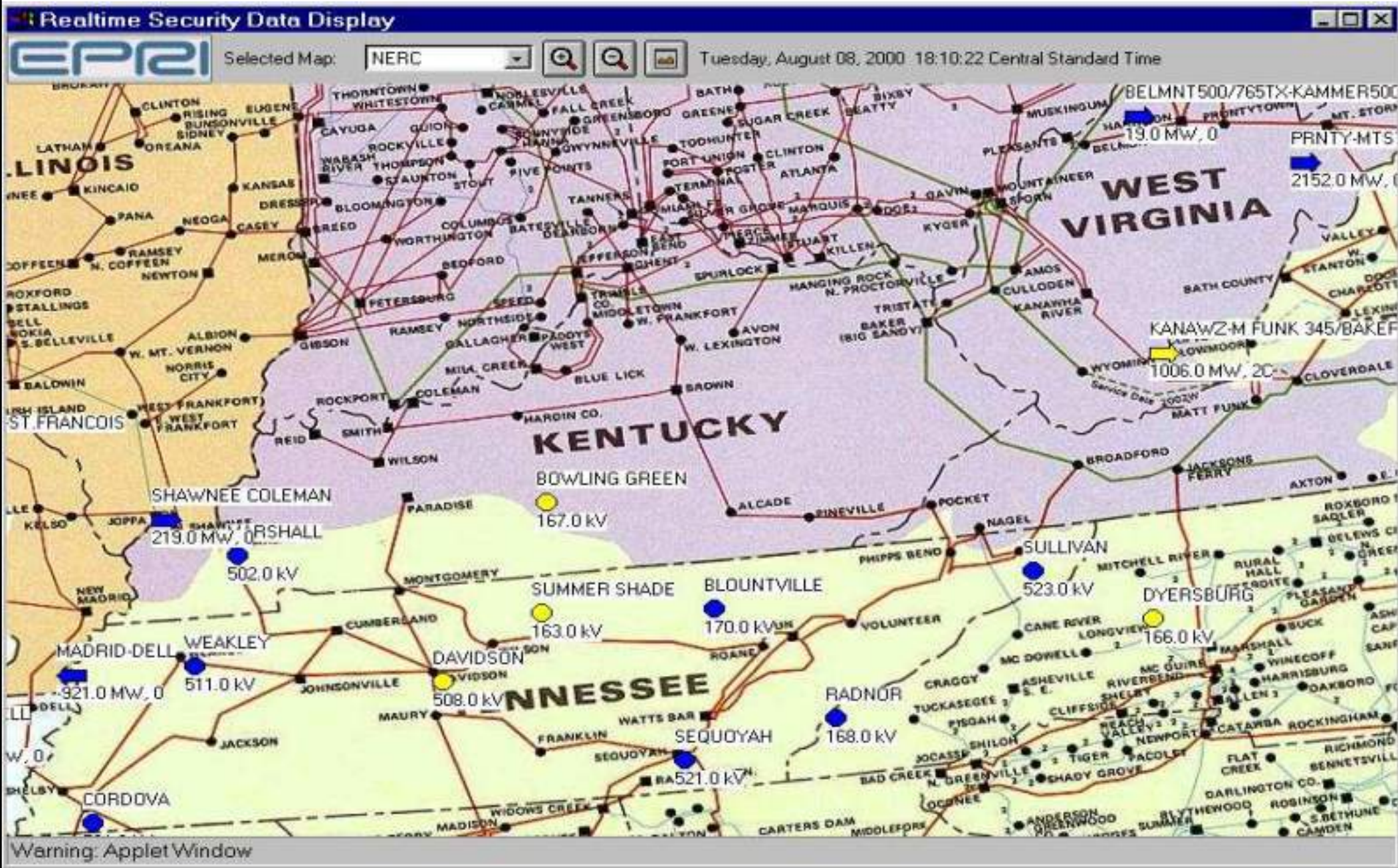


Look-Ahead Simulation Applied to Multi-Resolution Models

- Provides faster-than-real-time simulation
 - By drawing on approximate rules for system behavior, such as power law distribution
 - By using simplified models of a particular system
- Allows system operators to change the resolution of modeling at will
 - Macro-level (regional power systems)
 - Meso-level (individual utility)
 - Micro-level (distribution feeders/substations)



EPRI's Reliability Initiative-- Sample Screen of Real-time Security Data Display (RSDD)



Smart Grid (2002-present)

- **What is a smart grid?**

The term “smart grid” refers to the use of computer, communication, sensing and control technology which operates in parallel with an electric power grid for the purpose of enhancing the reliability of electric power delivery, minimizing the cost of electric energy to consumers, improving security, quality, resilience, robustness, and facilitating the interconnection of new generating sources to the grid.

- **What are the power grid’s emerging issues?** They include

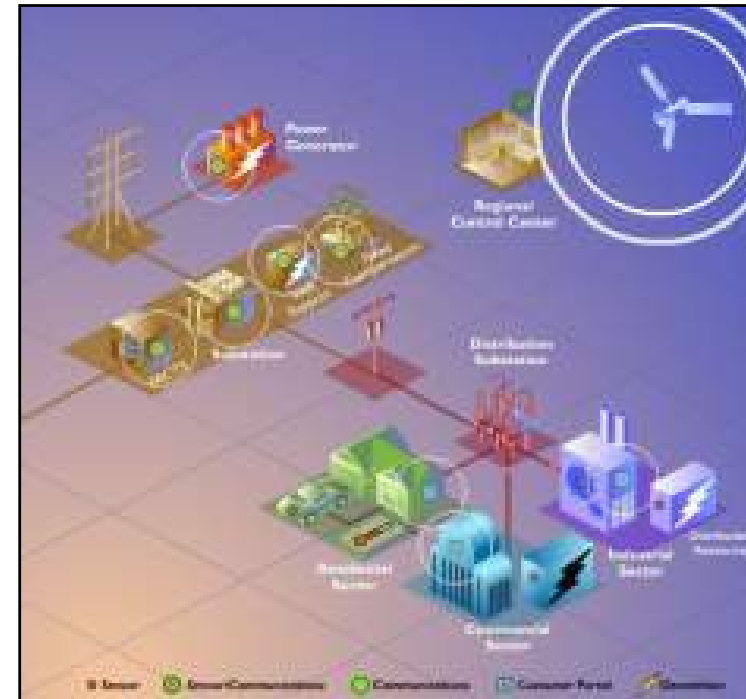
- 1) integration and management of DER, renewable resources, and “microgrids”;
- 2) use and management of the integrated infrastructure with an overlaid sensor network, secure communications and intelligent software agents;
- 3) active-control of high-voltage devices;
- 4) developing new business strategies for a deregulated energy market; and
- 5) ensuring system stability, reliability, robustness, security and efficiency in a competitive marketplace and carbon constrained world.



What are we doing about it?

Enabling Technologies

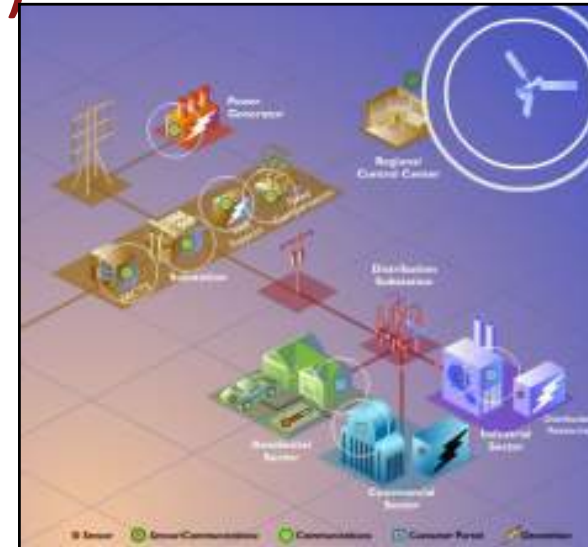
- **Monitoring:** WAMS, OASIS, SCADA, EMS:
 - Wide-Area Measurement Systems (WAMS), integrate advanced sensors with satellite communication and time stamping using GPS to detect and report angle swings and other transmission system changes.
- **Analysis:** DSA/VSA, PSA, ATC, CIM, TRACE, OTS, ROPES, TRELSS, market/risk assessment...
 - Information systems and on-line data processing tools such as the Open Access Same-time Information System (OASIS); and Transfer Capability Evaluation (TRACE) software-- determine the total transfer capability for each transmission path posted on the OASIS network, while taking into account the thermal, voltage, and interface limits.



What are we doing about it?

Enabling Technologies (cont.)

- **Control:** FACTS; Fault Current Limiters (FCL)., ...
 - Flexible AC Transmission System (FACTS): Up to 50% more power controlled through existing lines.
 - Fault Current Limiters (FCLs)-- large electrical “shock absorbers” for a few cycles
 - Intelligent Electronic Devices with security built in-- combining sensors, computers, telecommunication units, and actuators-- "intelligent agent" functions
- **Materials science:** High-temperature superconducting cables, advanced silicon devices and wide-bandgap semiconductors for power electronics.
- **Power Electronics** to enable integration of intermittent sources, connection to smart grid, and increased controllability.
- **Distributed resources** such as small combustion turbines, solid oxide and other fuel cells, photovoltaics, superconducting magnetic energy storage (SMES), transportable battery energy storage systems (TBESS), etc.



Enabling Technologies (cont.)



An example of a static VAR compensation installation.

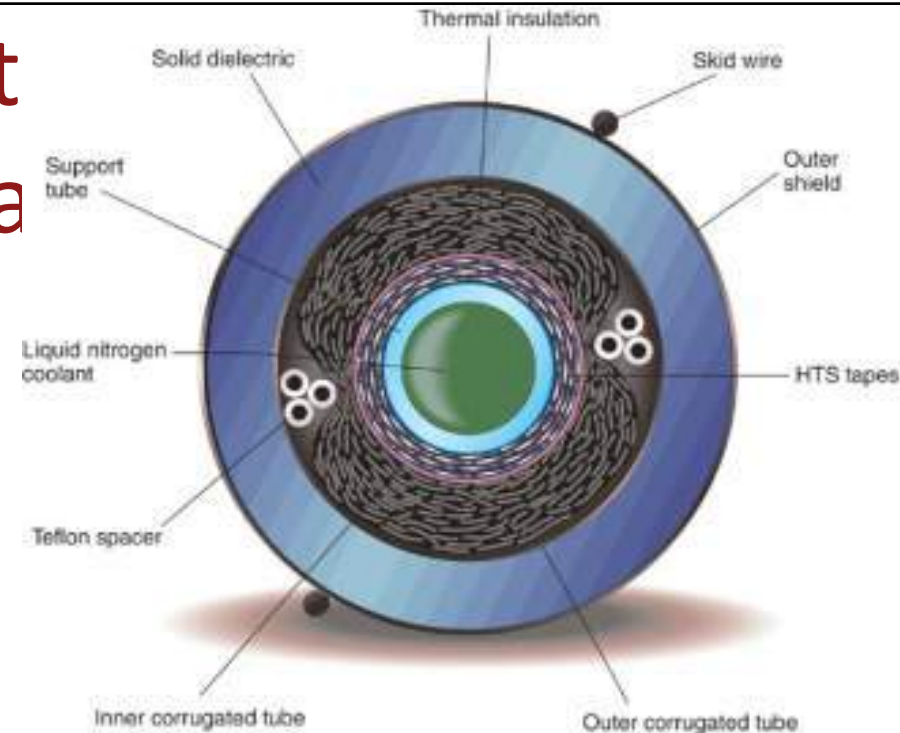


A gas insulated transmission line tunnel in Switzerland.

Technology Solut Maximize Utiliza

Superconducting Cables

- 2 to 5 times the current
- Can be used to retrofit existing ducts and pipes
- Need to reduce cost, improve reliability of cryogenic system and gain more operating experience



Energy Infrastructure, Economics, Efficiency, Environment, Secure Communications and Adaptive Dynamic Systems

Economics

Efficiency
Incentives
Private Good

Electric Power

Reliability
Public Good

“Prices to Devices”

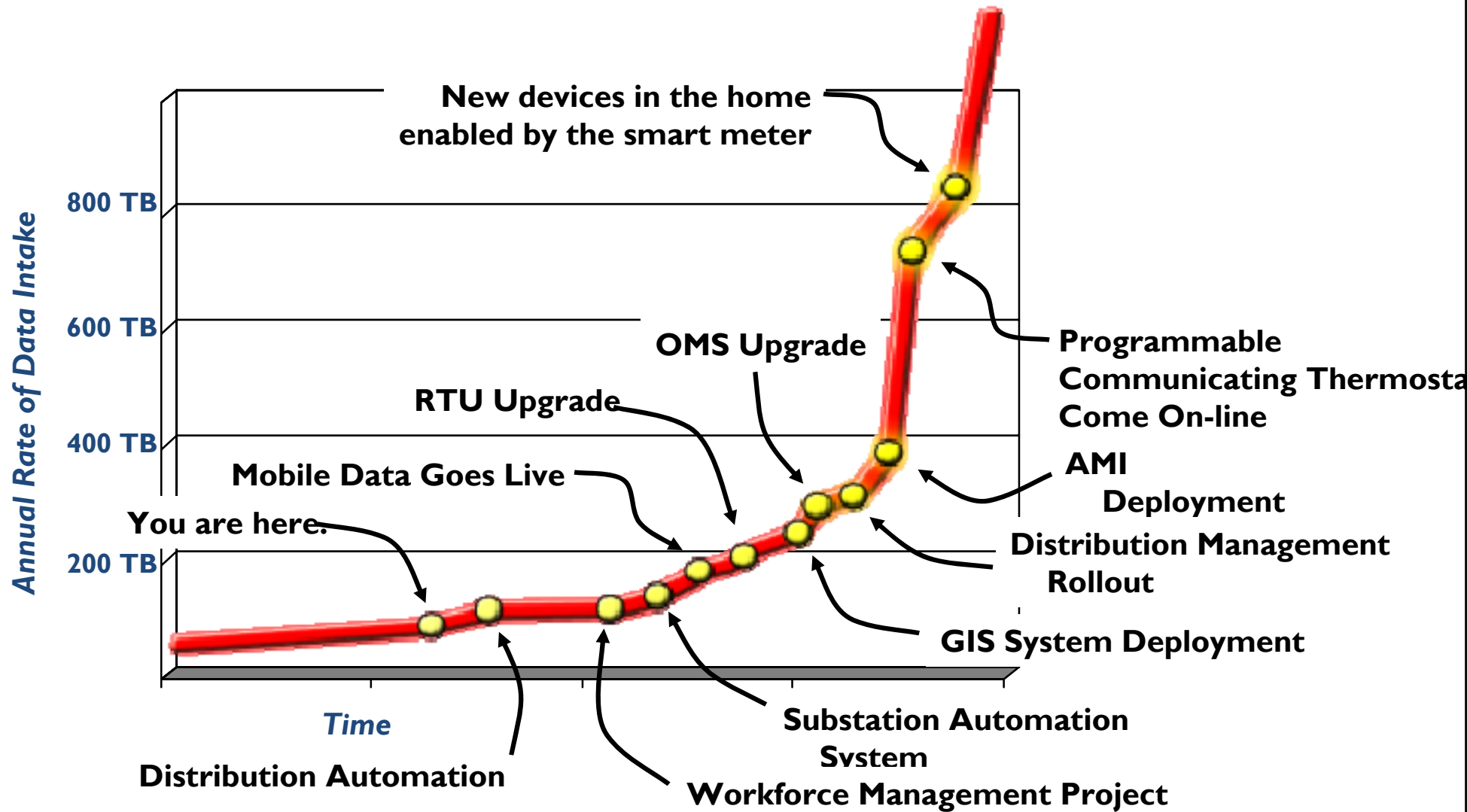
Complex, highly nonlinear infrastructure
Evolving markets, rules and designs

“if you measure it you manage it if you price it you manage it even better” ... Technologies, Designs, Policies, Options, Risks/Valuation

Adaptive Systems (self-healing)

Society (including Policy & Environment)

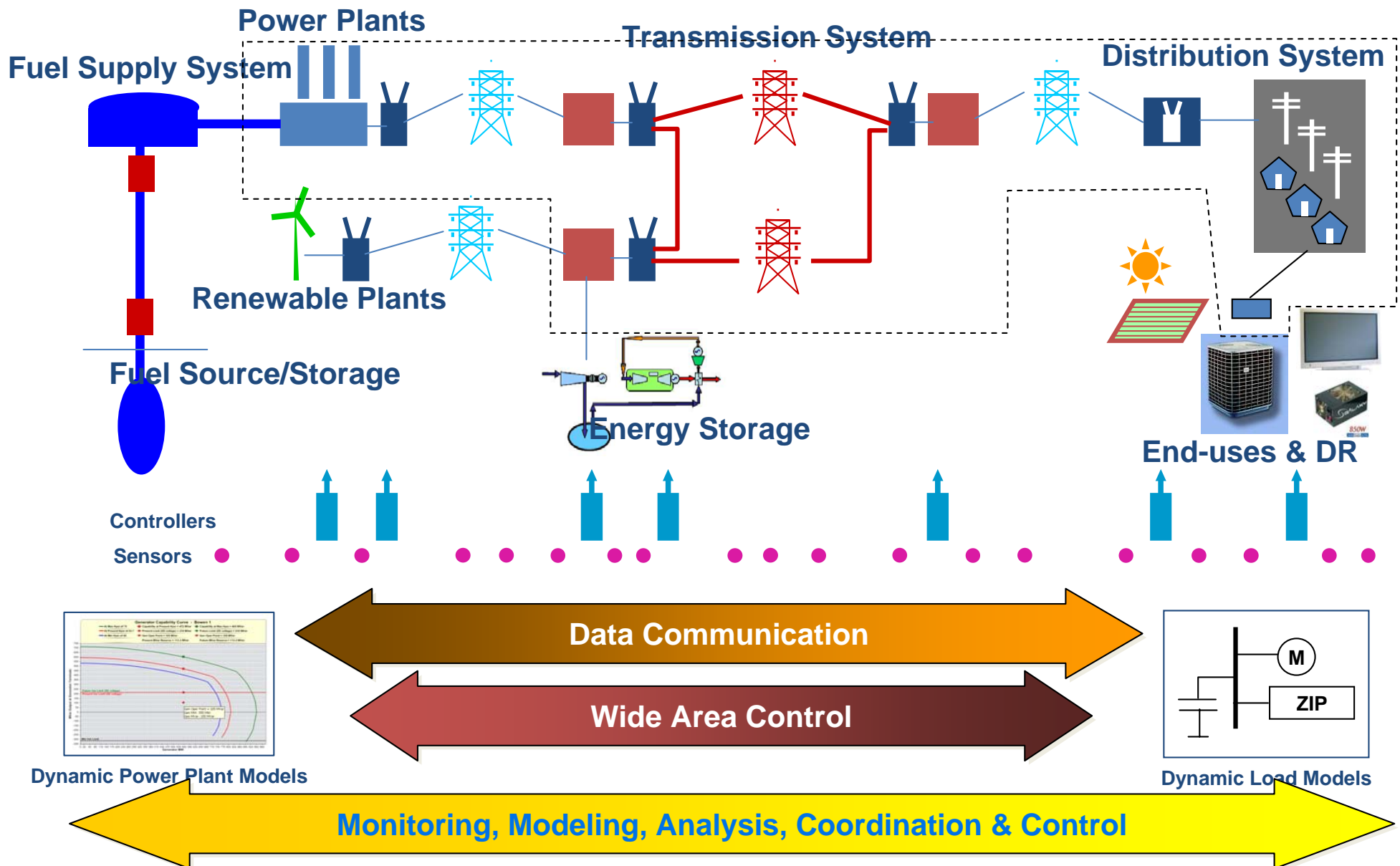
Smart Grid Field Data



**Tremendous amount of data coming from the field in the near future
- paradigm shift for how utilities operate and maintain the grid**

Smart Grid

End-to-End Power Delivery Operation & Planning

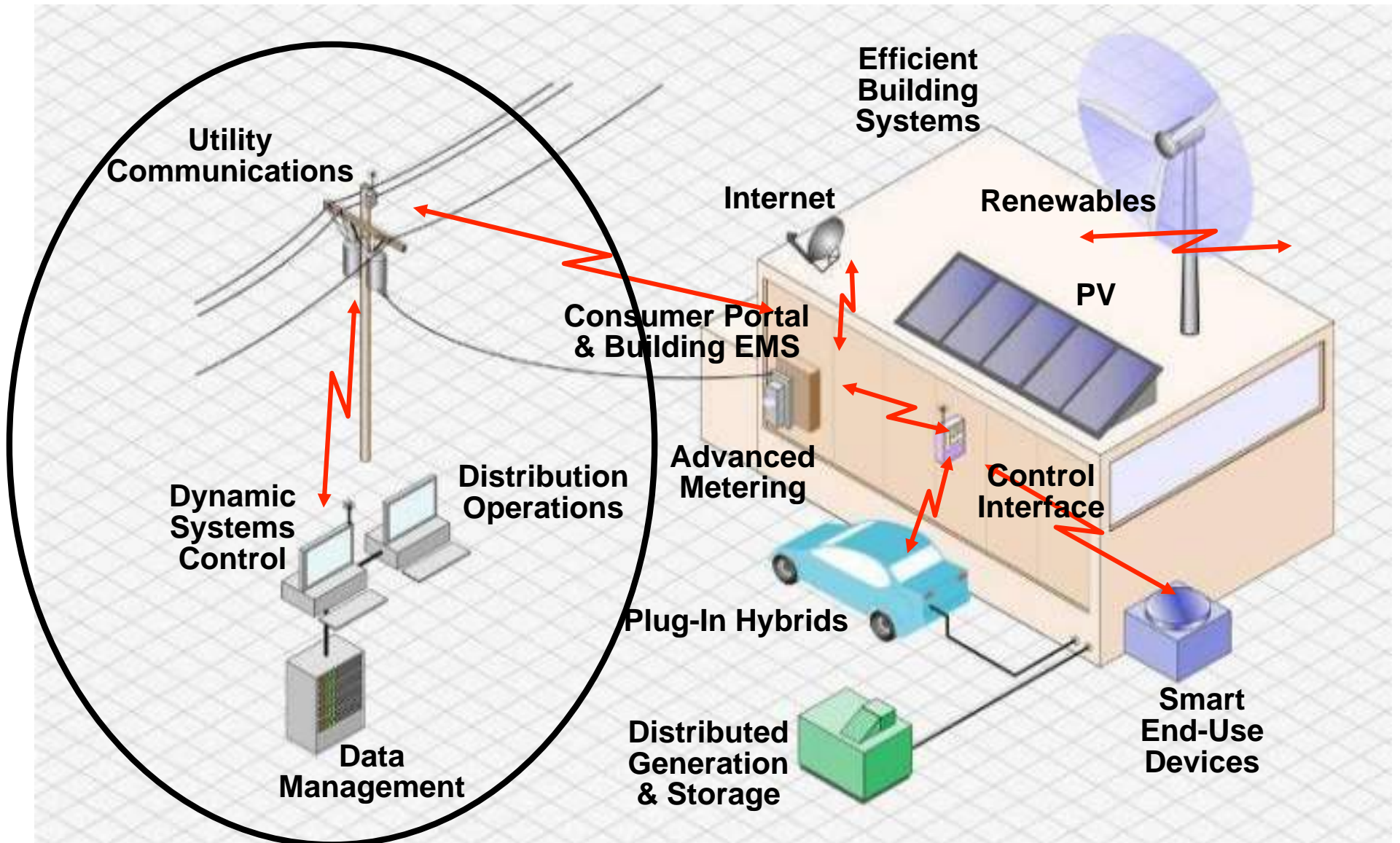


Smart Grid

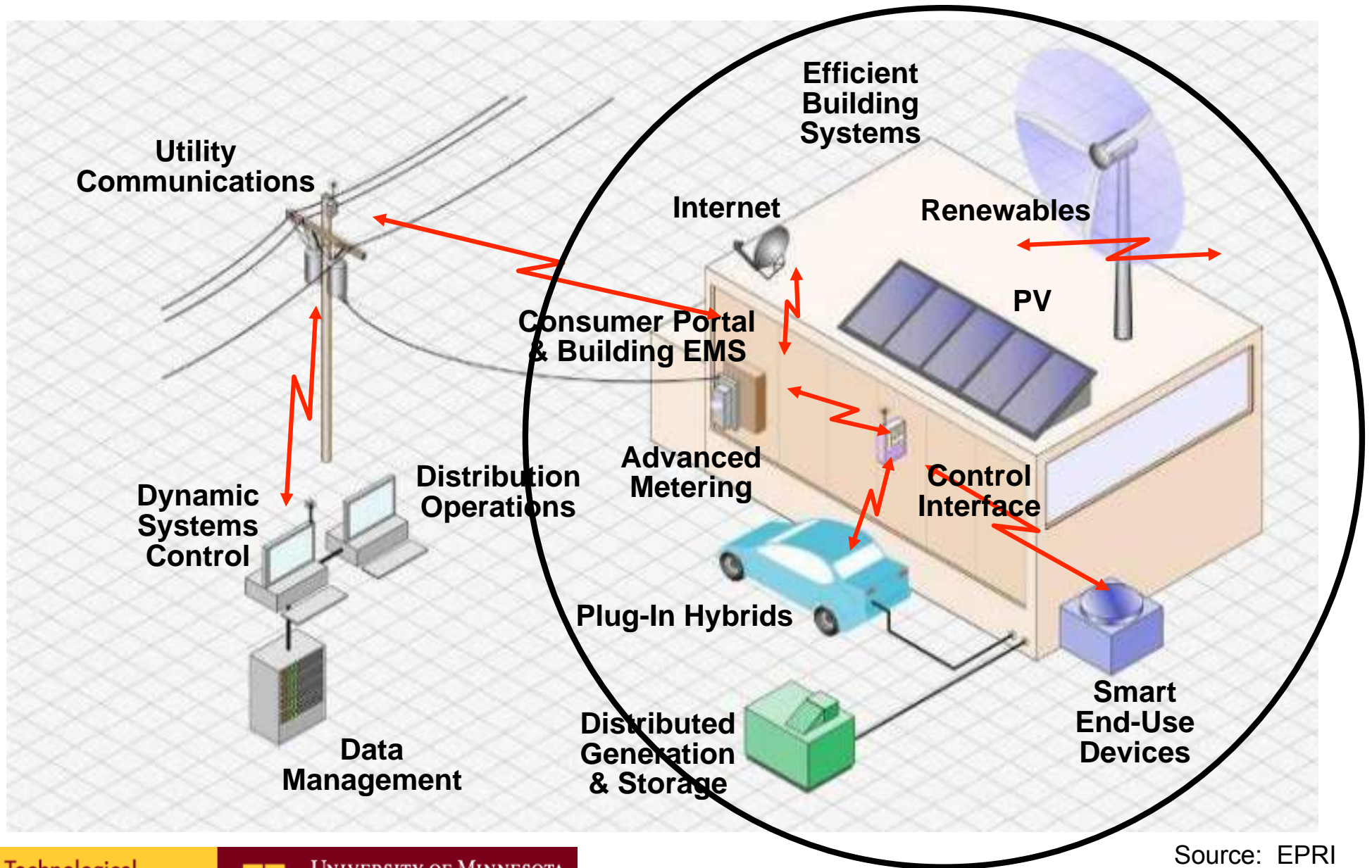
- **PEAK DEMAND** reduction through the application of smart devices and how they might affect consumer behavior and enable renewable and distributed energy resources
- **ASSET UTILIZATION** assets better utilized through improved demand-side management and infrastructure investment deferrals
- **RELIABILITY** improved through the application of smarter sensing, communication and control devices
- **REDUCED EMISSIONS** of environmental pollutants, e.g., carbon dioxide, and reliance on foreign-supplied fuels



Smart Grids and Local Energy Networks



Smart Grids and Local Energy Networks

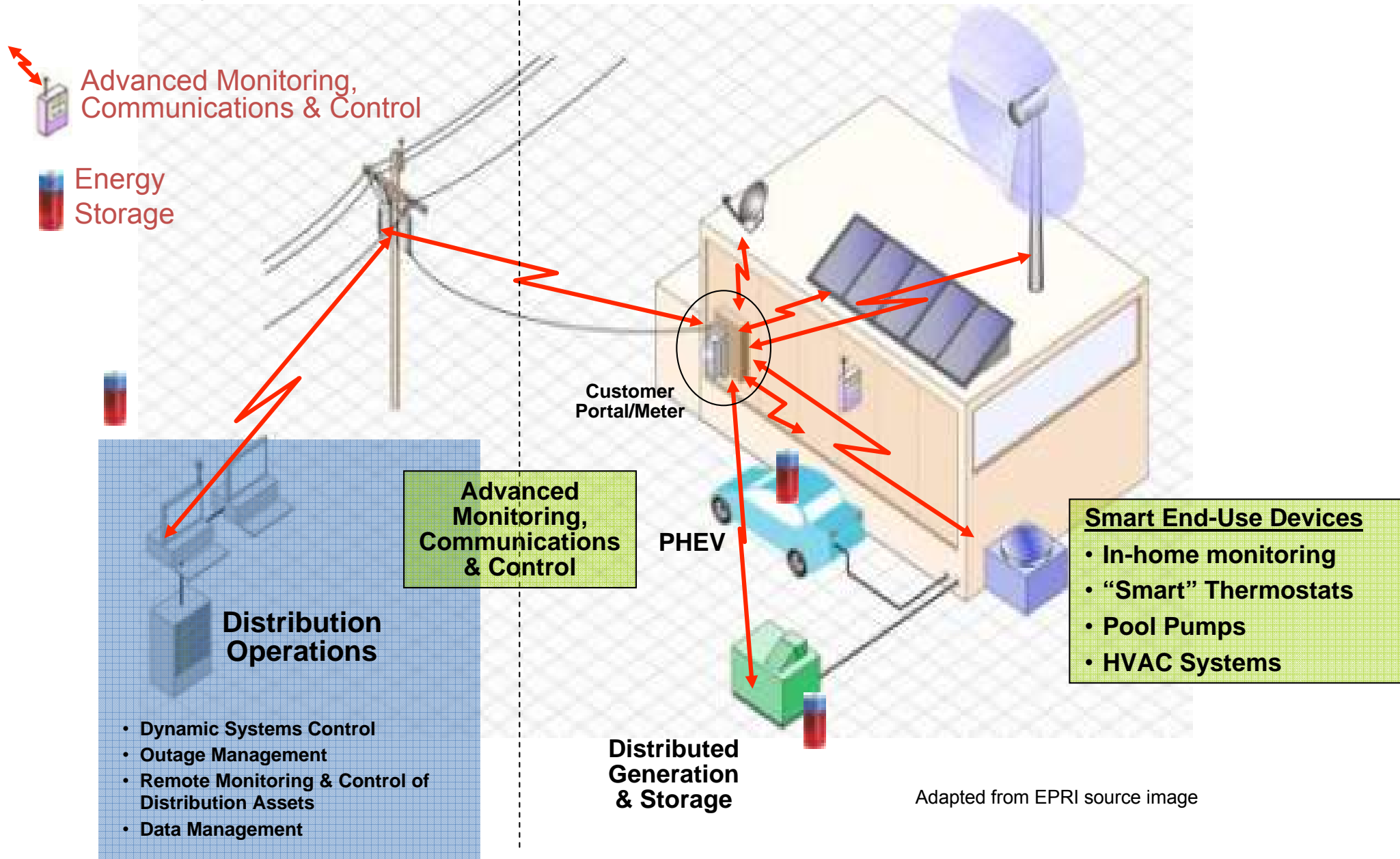


Source: EPRI

Distribution Operations of the Future

Utility Operations

Customer Premise



Advanced Monitoring, Communications & Control

Energy Storage

Customer Portal/Meter

PHEV

Distributed Generation & Storage

- Smart End-Use Devices**
- In-home monitoring
 - “Smart” Thermostats
 - Pool Pumps
 - HVAC Systems

- Distribution Operations**
- Dynamic Systems Control
 - Outage Management
 - Remote Monitoring & Control of Distribution Assets
 - Data Management

Advanced Monitoring, Communications & Control

Adapted from EPRI source image

The Emerging Smart Grid or Energy Web: A Complex Adaptive Infrastructure System

“... not to sell light bulbs, but to create a network of technologies and services that provide illumination...”

“The best minds in electricity R&D have a plan: Every node in the power network of the future will be awake, responsive, adaptive, price-smart, eco-sensitive, real-time, flexible, humming and interconnected with everything else.”

-- Wired Magazine, July 2001

<http://www.wired.com/wired/archive/9.07/juice.html>

Enabling a Stronger and Smarter Grid

• Smart Grid Challenges/Opportunities:

- Infrastructure for Generation/Transmission/Distribution Systems
- Infrastructure for Smart Customer Interface
- Distribution Automation
- Smart metering improves load models and profiles
- **Distributed Sensing and Control**
- Device monitoring and self-healing diagnostics
- Communication infrastructure provides opportunities for monitoring and diagnostics
- Fault detection, sensor networks, etc. for smart grid
- **Alternative Smart Grid Architectures**
- **Infrastructure Security: Controls, Communications and Cyber Security**
- Markets and Policy
- Distributed generation and storage adds complexity



Foresight

**Renewables/infrastructure integration,
Electrification of transportation**



- **“Wind power could blow electric grid:** Utilities and developers are poised to more than quadruple the amount of wind power in the Northwest, but a study shows the electric grid might not be able to handle it all, *The Oregonian* reported. The federal Bonneville Power Administration said in its assessment it has space on the grid to add only one-third of the planned 4,716 megawatts without additional power lines, the newspaper reported. A total of 6,000 megawatts of wind would supply about 8% of the Northwest's electricity needs, according to the BPA report. "A resource isn't very valuable unless you can deliver it," Elliot Mainzer, a transmission manager with the power agency, told *The Oregonian*. Bringing lines from the current grid to new wind farms costs up to \$3 million a mile...”

CNN Money.com
A Service of CNN, Fortune & Money

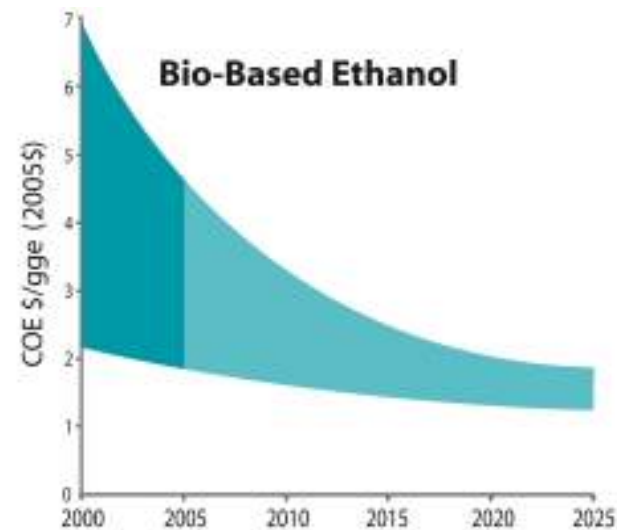
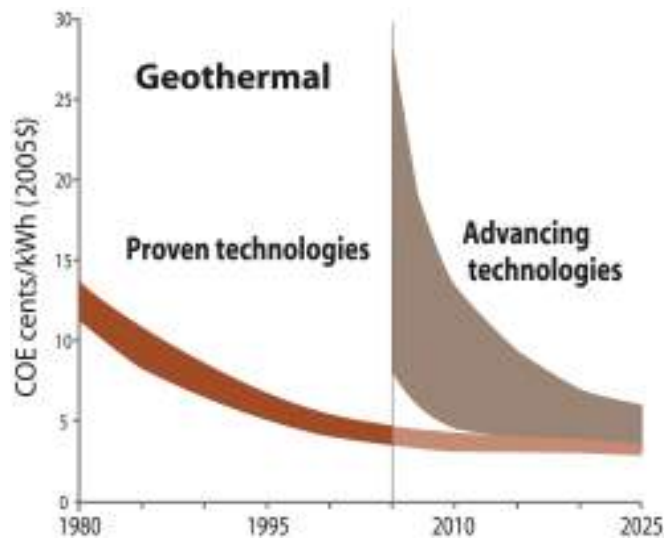
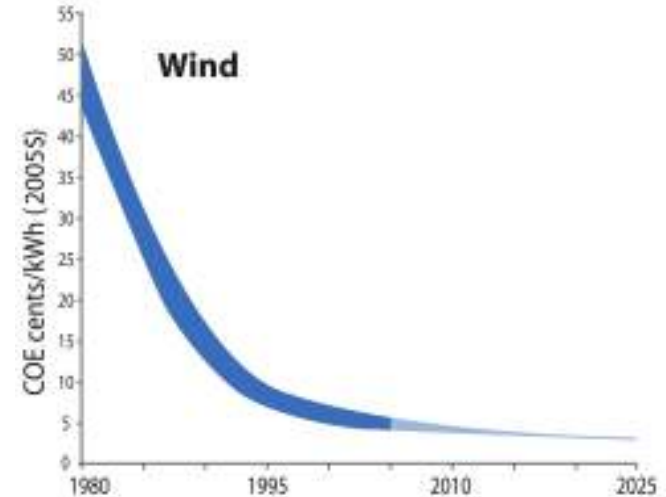
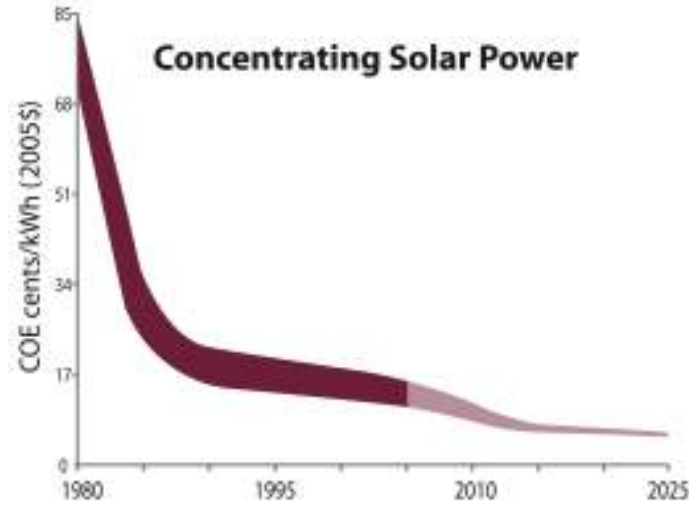
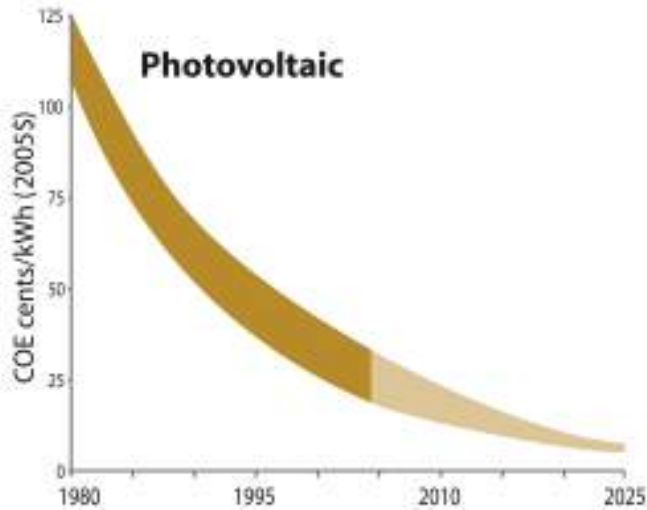
(July 22, 2008)

- **“GM, utilities team up on electric cars:** Partnership aims to tackle issues that will crop up when electric vehicles are rolled out... General Motors Corp. has joined with more than 30 utility companies across the U.S. to help work out electricity issues that will crop up when it rolls out new electric vehicles in a little more than two years.”



Renewable Energy Cost Trends

Levelized cost of energy in constant 2005\$¹

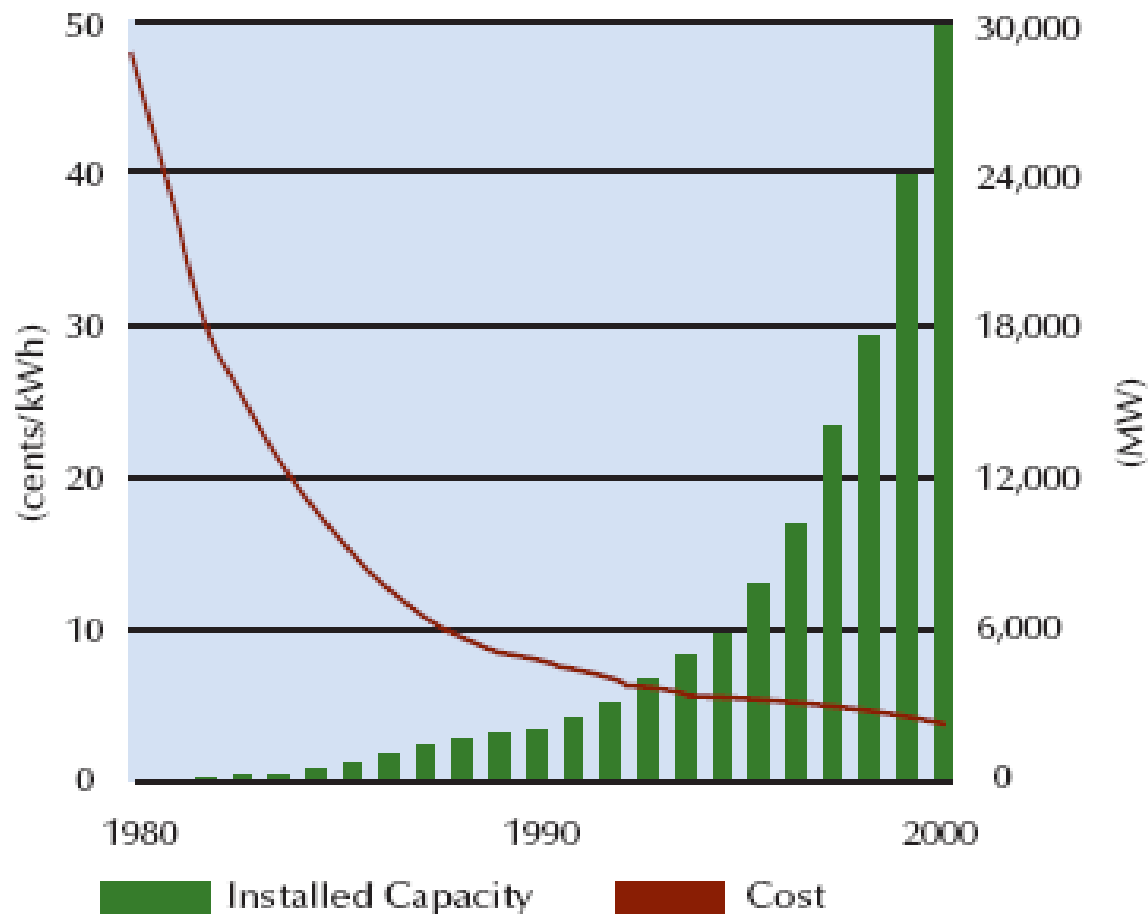


Source: NREL Energy Analysis Office (www.nrel.gov/analysis/docs/cost_curves_2005.ppt)

¹These graphs are reflections of historical cost trends NOT precise annual historical data.

Declining Cost of Wind Power

As experience grows and technology improves with more wind turbine installations, the costs of wind power have dramatically decreased over the past two decades.



The Energy Foundation, 2004

Deployment in Megawatts

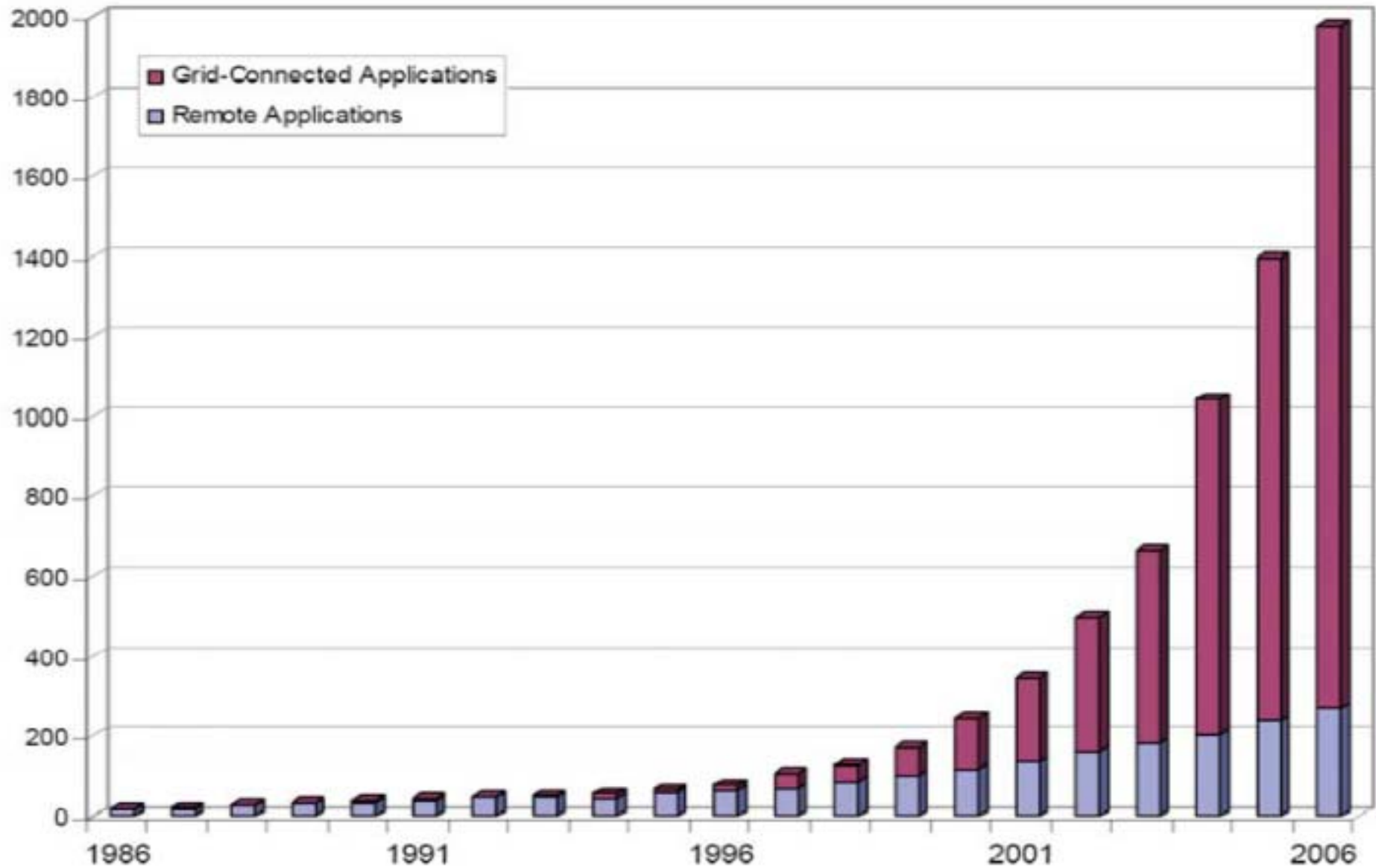
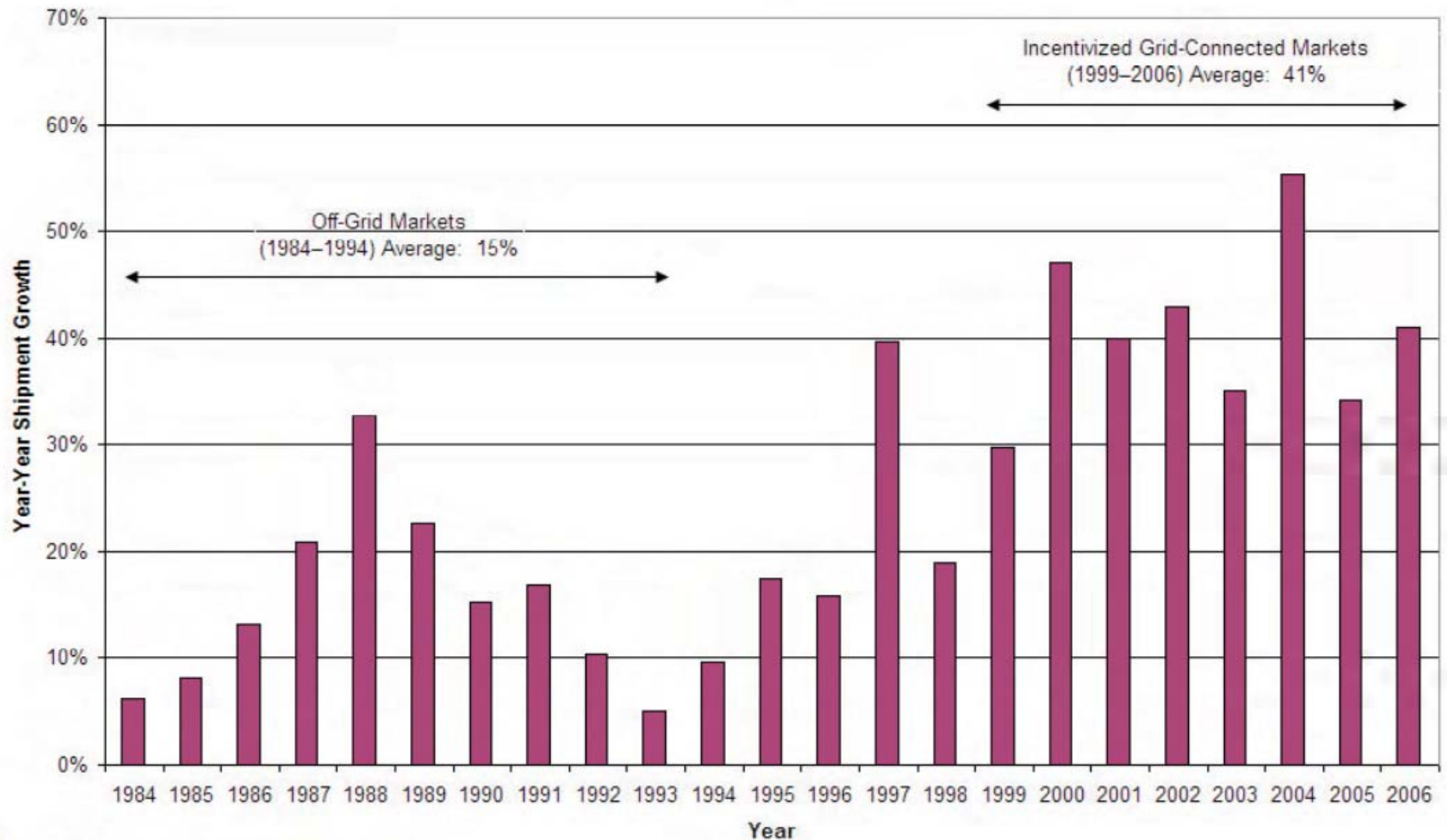


Figure 9
Proportion of Grid-Connected vs. Off-Grid PV Applications Worldwide, 1986-2006 (Source: Navigant Consulting PV Service Practice)

Annual PV Module Shipment Growth



Data source: Navigant Consulting PV Service Practice

Figure 10
Before incentives for grid-tied systems in Japan, Germany, and California took effect, annual PV module shipments grew at 15% on average, mainly in off-grid applications. Subsidies boosted average annual growth to 41% overall. (Data source: Navigant Consulting PV Service Practice)

Distributed PV: Japan

Japanese policies have emphasized distributed rather than centralized solar power production, as illustrated by residential developments in Sapporo, a designated "Solar City."

Sapporo established a goal of reducing per capita carbon dioxide emissions in 2012 by 10% compared to 1990 levels. The city has active programs to increase public awareness, stimulate citizen initiatives, provide incentives, and host city-sponsored activities. Local schools are hosting five 10-kW solar power demonstration projects, and a suburban residential complex with 500 homes will be equipped with 1,500 kW of rooftop PV (3 kW per house) when completed in 2008. In addition to encouraging solar power, Sapporo has installed several large cogeneration projects that utilize waste heat from steam turbines, thereby increasing the overall efficiency of energy production.

Many other "Solar Cities" have instituted similar goals and programs, including Copenhagen, Denmark; Barcelona, Spain; Qingdao, China; Adelaide, Australia; Freiburg, Germany; and Portland, Oregon.



Utility-Scale PV: Germany

Due to the structure of its incentive policies, Germany is a world leader in centralized PV deployment, with several megawatt-scale plants in operation or development.

The 10-MW Bavaria Solarpark, dedicated in June 2005, includes ground-mounted PV systems at three sites: the 6.3-MW Solarpark Mühlhausen, the 1.9-MW Solarpark Günching, and the 1.9-MW Solarpark Minihof. All together, the three projects comprise 57,600 solar panels over 62 acres of land. Cumulatively, they make up the largest PV plant in the world.

The Bürstadt Plant in Bürstadt is a 5-MW system incorporating building-integrated and roof-mounted systems. It was completed in February 2005. Solarpark Leipziger in Espenhain is a 5-MW system built in August 2004. The facility has both stand-alone and grid-connected PV elements. The Solarpark Geiseltalsee/Merseburg employs 25,000 mono- and polycrystalline modules from BP Solar to generate 4 MW of electricity. At the time of its completion in September 2004, it was the fifth largest PV plant in the world.

Central-Station PV: 6.3-MW Solarpark Mühlhausen (Credit: SunPower)





Central-Station PV: 4-MW Solarpark Geiseltalsee (Credit: BP plc)

Technological
Leadership Institute



UNIVERSITY OF MINNESOTA
Driven to DiscoverSM

Source: courtesy of Dr. Terry Peterson, EPRI white paper 1016279, Dec. 2007:
http://mydocs.epri.com/docs/SEIG/1016279_Photovoltaic_White_Paper_1207.pdf
© 2009 No part of this presentation may be reproduced in any form without prior authorization.

Building-Integrated PV: New York City

Building-Integrated PV in New York City (Credit: Schott AG)



Reconstruction of New York's Stillwell Avenue subway station provided an opportunity to integrate amorphous silicon thin-film PV into a semi-opaque roof canopy that, upon its completion in 2005, was one of the largest building-integrated PV (BIPV) structures in the world.

The station's canopy roof was constructed with ASI solar modules from Schott Solar to provide the station with electricity as well as shade. Some 2,800 thin-film modules covering 76,000 square feet (7,060 m²) generate approximately 210 kW while permitting 20% to 25% of daylight to pass through. During summer, the system provides approximately two-thirds of the station's power needs (not related to powering the trains). Its annual output is about 250,000 kWh.



Planning and design took more than four years, and the station's design process was done in conjunction with an educational component that included a large-scale industry workshop involving several major companies in the photovoltaics industry. The station was designed so its architecture would invoke the historic architecture of nearby Coney Island and provide passengers with a grand sense of arrival, elegance, and civic pride.

Source: courtesy of Dr. Terry Peterson, EPRI white paper 1016279, Dec. 2007:

http://mydocs.epri.com/docs/SEIG/1016279_Photovoltaic_White_Paper_1207.pdf

© 2009 No part of this presentation may be reproduced in any form without prior authorization.

Tracking PV: Portugal

Central-Station Tracking PV in Portugal (Credit: SunPower)

In March 2007, GE Energy Services, PowerLight, and Catavento commissioned an 11-MW solar power plant in Serpa, Portugal. The station's 52,000 modules from SunPower, Sanyo, Sharp and Suntech cover 150 acres (60 hectares) and employ the SunPower® single-axis tracking system to keep the PV panels pointing toward the sun, increasing their daily electricity output by up to 35%. The project cost approximately \$150 million.

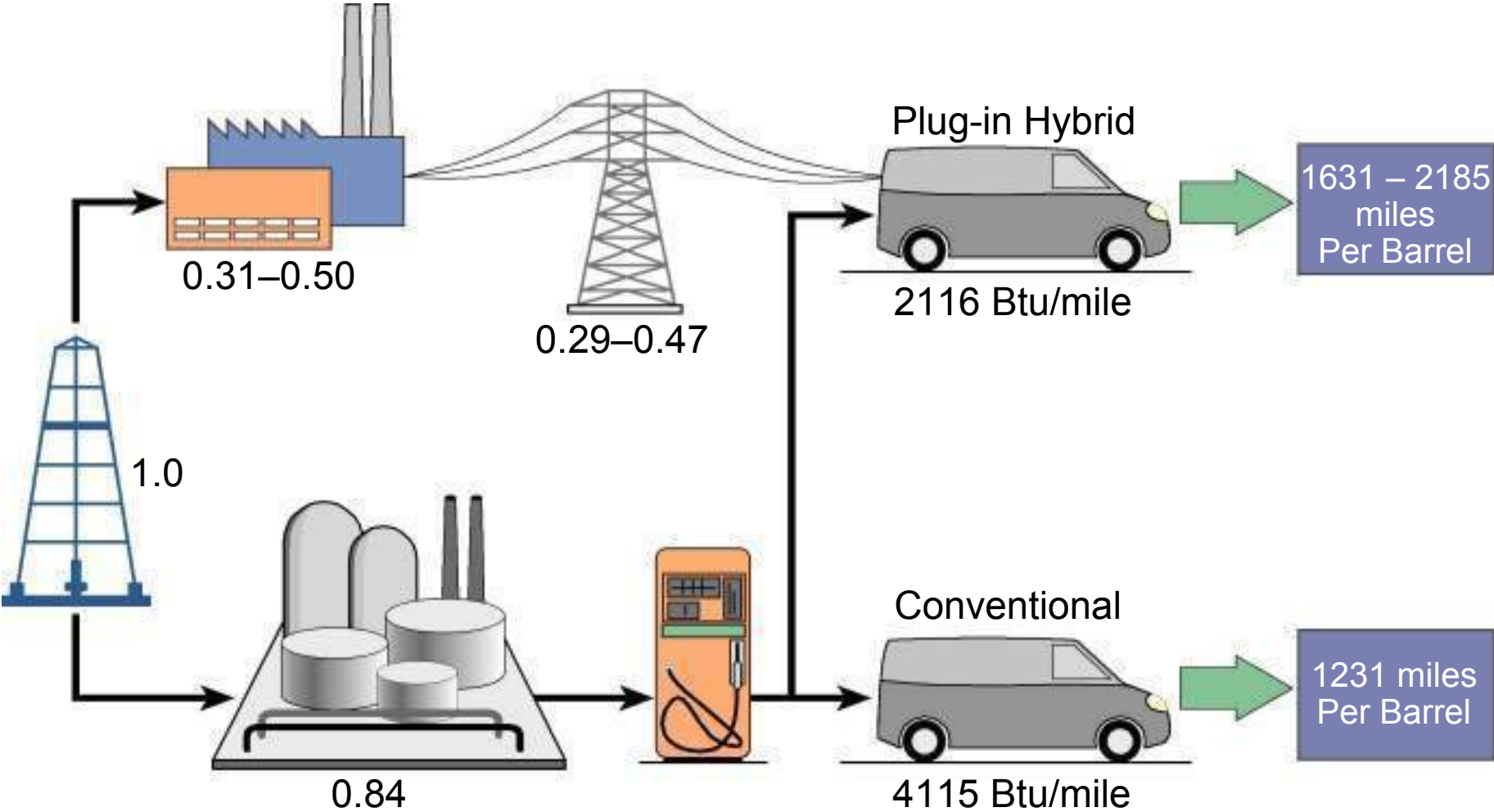


Portugal relies heavily on imported fossil fuels and has implemented aggressive incentives for renewable energy installations. A key component of Portugal's "Energy Efficiency and Endogenous Energies" (E4) program is a \$0.317/kWh to \$0.444/kWh feed-in tariff for both ground-mounted and rooftop solar power systems with a 15-year power purchase guarantee. Adopted in 2001, the E4 program is expected to provide 4,400 MW of renewable energy by 2010, 150 MW of it in the form of PV.

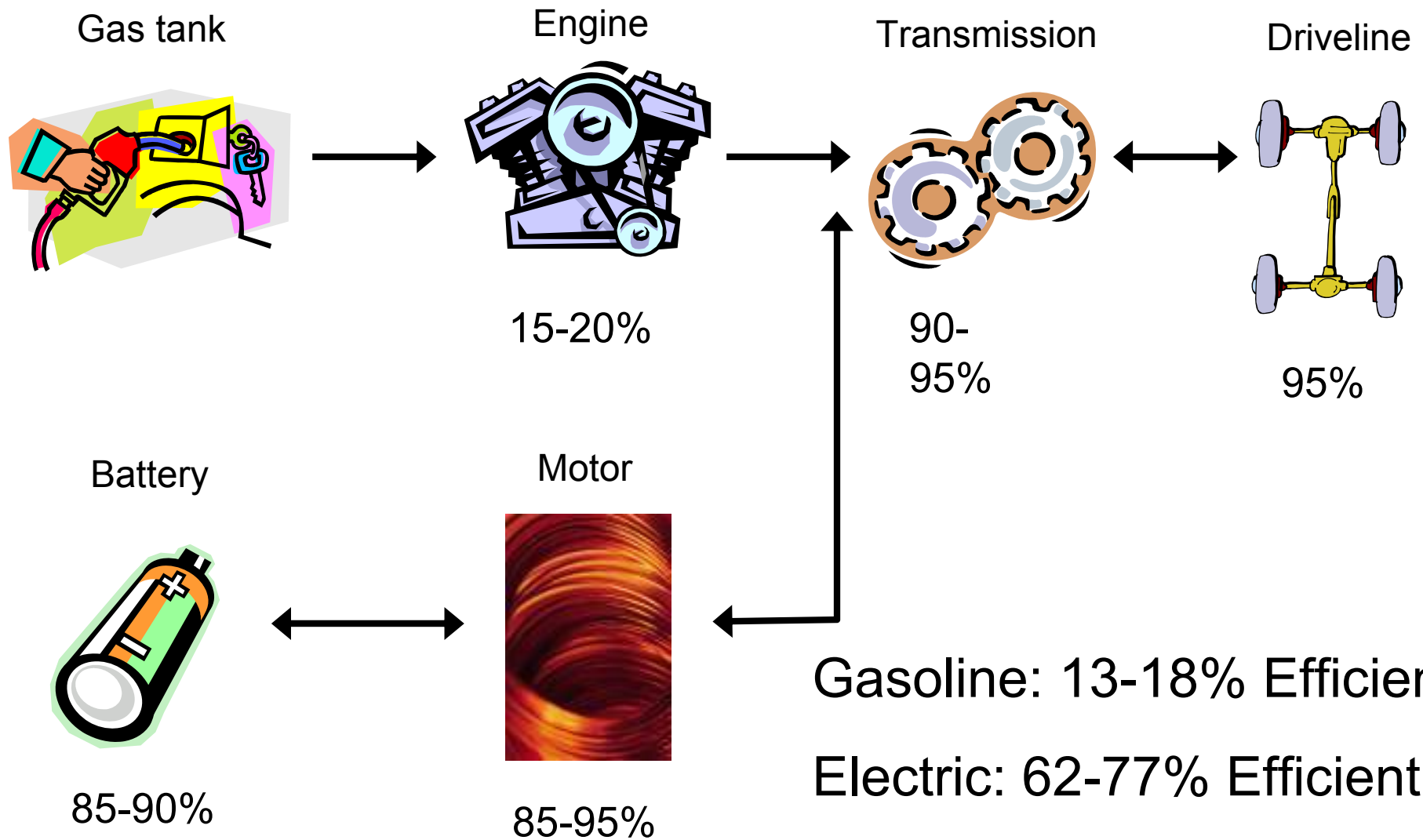


Figure 9. Parabolic trough CSP plants (such as the one in California, pictured here) utilize a mature technology; 419 MW of capacity are currently operating in the U.S., while several 50-MW plants are under construction in Spain. Source: Alan Radecki.

Full Fuel Cycle Efficiency Comparison



Hybrid Vehicle Efficiency



Gasoline: 13-18% Efficient

Electric: 62-77% Efficient

Policy

Summary of numbers: Direct Spending

Total Direct Spending for Renewable Energy and Energy Efficiency: The bill provides \$16.8 billion in direct spending for renewable energy and energy efficiency programs over the next ten years.

Grid Development: The bill provides \$4.5 billion to modernize the nation's electricity grid with smart grid technology. The bill increases federal matching grants for the Smart Grid Investment Program from 20% to 50%.

R&D, Demonstration Projects: The bill provides \$2.5 billion for renewable energy and energy efficiency R&D, demonstration and deployment activities.

Federal Power Marketing Administrations: The bill provides \$6.5 million for capital investments by certain federal power marketing administrations in electric power transmission systems.

Advanced Battery Grants: The bill provides \$2 billion for grants for the manufacturing of advanced batteries and components. This includes the manufacturing of advanced lithium ion batteries, hybrid electrical systems, component manufacturers, and software designers.

Defense Energy and Efficiency Programs: The bill provides \$300 million to the DOD for the purpose of research, testing and evaluation of projects to energy generation, transmission and efficiency. The bill provides an additional \$100 million for Navy and Marine Corps facilities to fund energy efficiency and alternative energy projects.

Study of Electric Transmission Congestion: The bill requires the Secretary of Energy to include a study of the transmission issues facing renewable energy in the pending study of electric transmission congestion that is due to be issued in August 2009.

Summary of numbers: Tax Incentives

Three-Year Extension of PTC: The bill provides a three-year extension of the Production Tax Credit (PTC) for electricity derived from wind facilities through December 31, 2012, as well as for geothermal, biomass, hydropower, landfill gas, waste-to-energy and marine facilities through December 31 2013.

Investment Tax Credit (ITC) Accessible to All Renewable Energy: The bill provides project developers of wind, geothermal, biomass and other technologies eligible for the PTC, the option of instead utilizing the 30% ITC that previously only applied to solar and other clean technology projects.

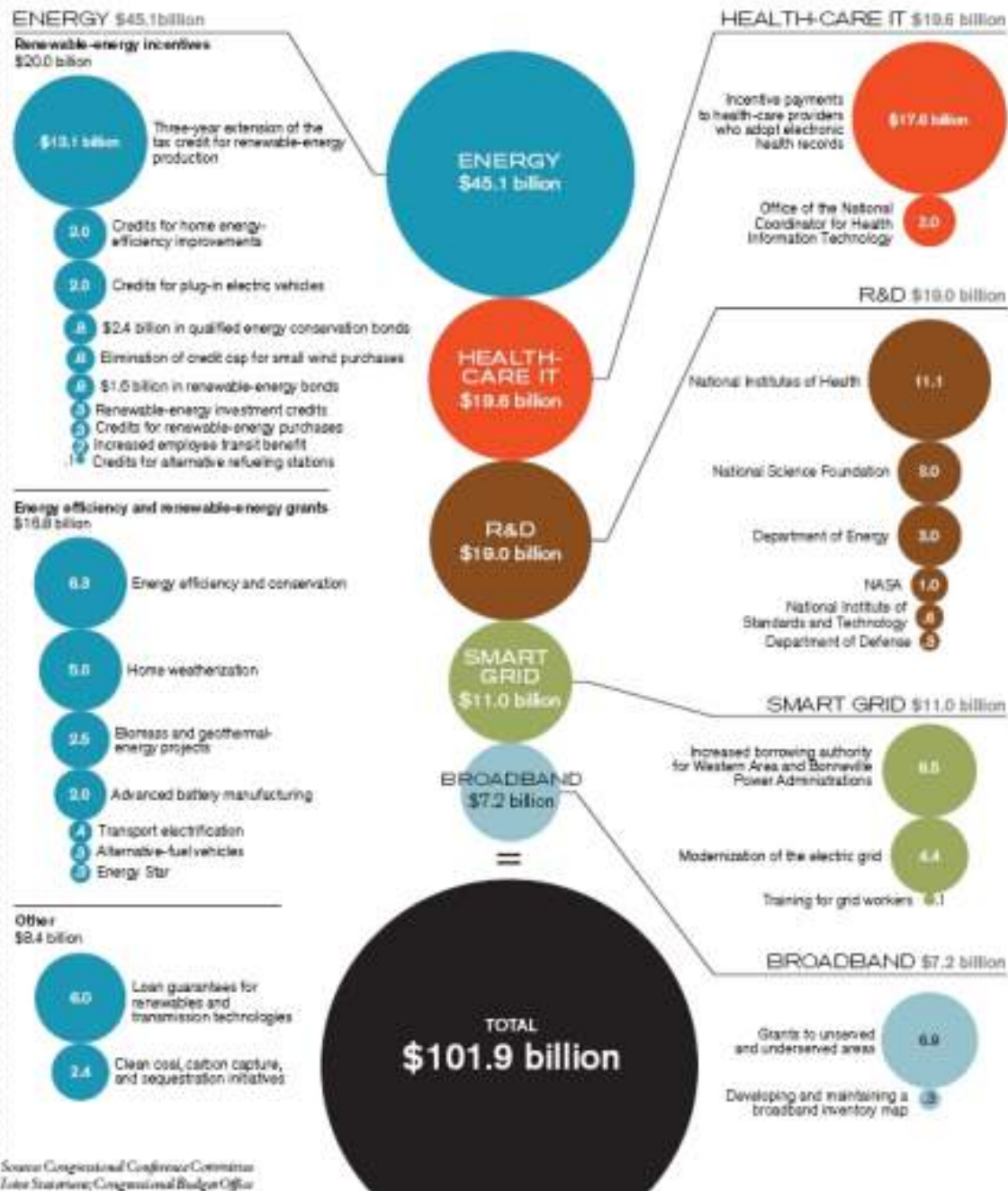
Advanced Energy Manufacturing Credits: The bill provides \$2 billion worth of energy related manufacturing investment credits at a 30% rate. These credits apply to projects creating or retooling manufacturing facilities to make components used to generate renewable energy, storage systems for use in electric or hybrid-electric cars, power grid components supporting addition of renewable sources, and equipment for carbon capture and storage (CCS).

Plug-in Electric Drive Vehicle Credit: The bill increases the tax credit for qualified plug-in electric drive vehicles for the first 200,000 placed in service. The base amount of the credit is \$2500. Batteries with at least 5 kilowatt hours of capacity have a credit of \$2917. The credit is further increased by \$417 for every kilowatt hour in excess of 5 kilowatt hours, but cannot exceed \$5000. The credit is allowed to be taken against the alternative minimum tax.

Who Gets What?

WHO GETS WHAT

Breakdown of technology, energy, and R&D spending in the \$787 billion economic stimulus act signed into law February 17, 2009



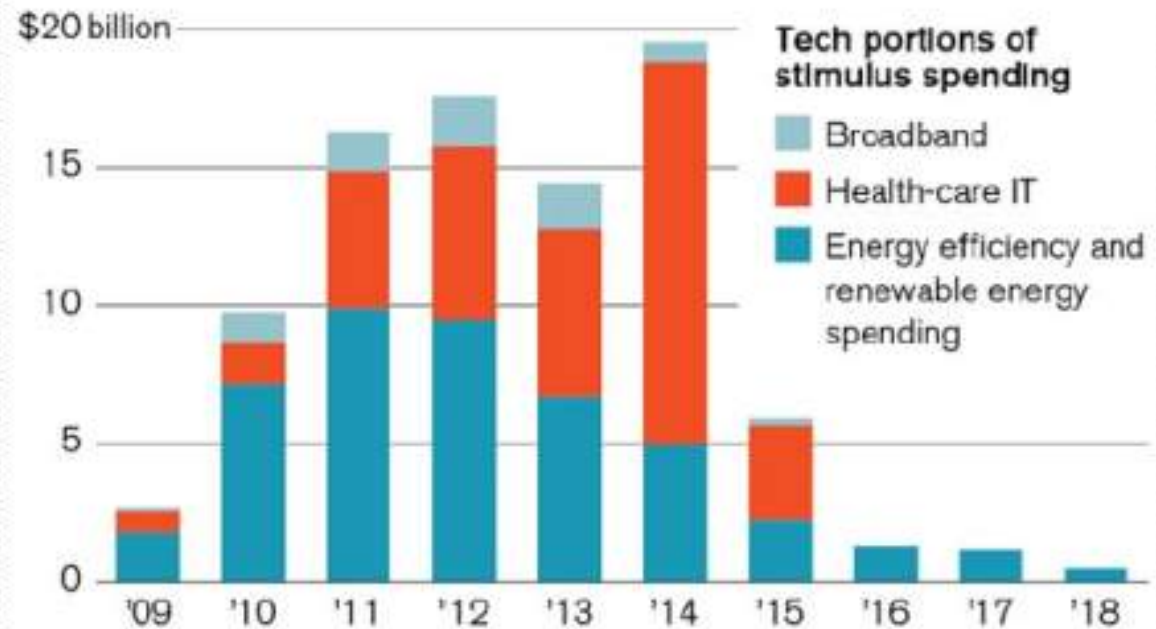
Technology Review, MIT, May/June 2009

Jobs created

JOBS WILL BE CREATED ...
Estimate of jobs created or retained per \$10 billion invested



... BUT IT WILL TAKE TIME FOR THE STIMULUS MONEY TO BE SPENT.



Source: Information Technology and Innovation Foundation; Congressional Budget Office

Technology Review, MIT, May/June 2009

Smart Grid Initiatives

Related on-going R&D include

- EPRI: UCA, CIN/SI, Intelligrid, Fast Simulation and Modeling
- Initiatives at several utilities, including Xcel, AEP, Austin Energy, SCE, PG&E, ISOs, and also in companies including GE, Honeywell, IBM, Siemens, etc.
 - Austin Energy journey as an example:
 - Delivering SG1.0 (power plant - transmission, distribution - meter - customer info/bill and back) by August 2009 for 1 million consumers, 43,000 businesses, 440 square miles, 500,000 devices, and 100 terabytes.
 - Planning SG 2.0 (SG 1.0 integration to Smart Appliances, Distributed Generation, Storage, and Plug-in Hybrid EVs - EVs) via the Pecan Street Project - www.pecanstreetproject.org
- Energy Bill passed in December 2007: Title XIII Smart Grid, Sections 1301 -1309
 - Establishes a statement of policy supporting modernization of the grid; authorizes a biennial status report and survey of barriers to modernization
- US Department of Energy: Gridwise and Modern Grid Initiatives

Electric Power Research Institute



IntelliGridSM

www.epri-intelligrid.com/intelligrid/home.jsp



GridWorks

Multi-Year Plan



March 2005



Office of Electric Transmission and Distribution
United States Department of Energy

US Department of Energy

The logo for GRIDWISE, featuring the word "GRIDWISE" in a bold, sans-serif font. The "I" in "GRID" is stylized with a green arc above it and a black arc below it. The "W" in "WISE" is also stylized with a green arc above it and a black arc below it.

www.gridwise.org



National Institute of Science and Technology (NIST)

As part of the Energy Independence and Security Act (EISA) of 2007, the National Institute of Standards and Technology (NIST) has “primary responsibility to coordinate development of a framework that includes protocols and model standards for information management to achieve interoperability of smart grid devices and systems...” [EISA Title XIII, Section 1305]

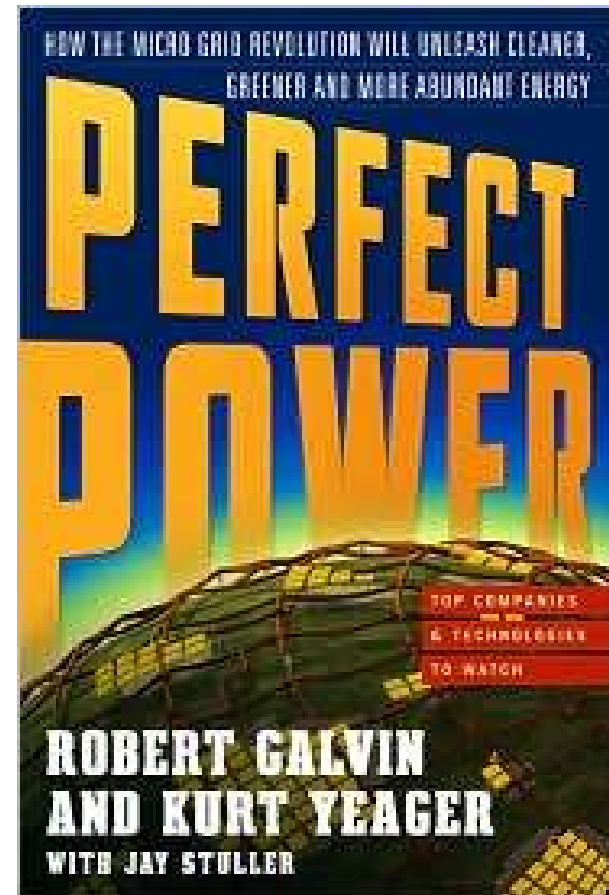


NIST Solar Energy Research,
from NIST Photographic Collection

Galvin Electricity Initiative

Working to transform the power grid into a “perfect power system” that cannot fail, through the use of smart microgrids.

<http://www.galvinpower.org/>



Demand Response *and* Smart Grid Coalition

“...is the trade association for companies that provide products and services in the areas of demand response, smart meters, and smart grid technologies.”

<http://www.drsgcoalition.org/index.html>



Source:
http://www.echelon.com/company/press/2009/images/smarthome_lg.jpg

SMART GRID NEWSLETTER

SMART
GRID
NEWSLETTER

Search

All Categories
[Advanced Search](#)

Site Menu

[Home](#)
[About](#)
[Resources](#)
[Contact Us](#)

Archives

[GridWise Alliance News](#)
[Industry News](#)
[Grid Automation](#)
[Grid Research](#)

In This Issue

FEATURE ARTICLE:

New Business Rules for Electricity's New Era

Other people will tell you this next year, when it is more obvious. We are telling you now. The transformation of the electric power industry has begun in earnest. It will take 20 years or more to complete, but many fortunes will be made and lost along the way. If you know what to look for, you can already spot likely winners. And likely losers. Read on for success strategies, including survival of the fittest, the fastest, and the fittest. [More>>](#)

GRIDWISE UPDATE:

DOE Meeting Sets Stage for Progress

This month's progress report includes an important DOE meeting, changes at the DOE, movement in energy legislation and continued bridge building by GridWise allies. [More>>](#)

NEWS & PROJECTS:

New Coalition for Grid Apps... B.C. Makes Push into Energy Tech... More

Several large utilities join coalition to fast-track new grid applications into the market... British Columbia launches major effort to promote energy technology innovation... California moves ahead with DG planning... [More>>](#)

RESEARCH & ARTICLES:

Advanced Metering at the "Boiling Point"... Best Practices in Smart Grid Incentives... Demand Side Technology Set for Growth

Advanced metering at "boiling point" says study... Utility CEOs White paper lists best practices in Smart Grid incentives... Survey finds demand side technology is a leading growth prospect... [More>>](#)

The insider's guide
to the modernization
and automation of
electric power

Join the monthly
Smart Grid Newsletter
Email News Alert

Enter your Email:

[More information](#)

Founding Sponsors



www.smartgridnews.com

Technological
Leadership Institute



UNIVERSITY OF MINNESOTA
Driven to DiscoverSM

© 2009 No part of this presentation may be reproduced in any form without prior authorization.

Xcel Energy

SMART GRID **CITY**TM



Related on-going R&D include

- EPRI: UCA, CIN/SI, Intelligrid, Fast Simulation and Modeling
- Initiatives at several utilities, including Xcel, AEP, Austin Energy, SCE, PG&E, BG&E, ISOs, and also in companies including GE, Honeywell, IBM, Siemens, etc.
 - Austin Energy journey as an example:
 - Delivering SG1.0 (power plant - transmission, distribution - meter - customer info/bill and back) by August 2009 for 1 million consumers, 43,000 businesses, 440 square miles, 500,000 devices, and 100 terabytes.
 - Planning SG 2.0 (SG 1.0 integration to Smart Appliances, Distributed Generation, Storage, and Plug-in Hybrid EVs - EVs) via the Pecan Street Project - www.pecanstreetproject.org
- Energy Bill passed in December 2007: Title XIII Smart Grid, Sections 1301 -1309
 - Establishes a statement of policy supporting modernization of the grid; authorizes a biennial status report and survey of barriers to modernization
- US Department of Energy: Gridwise and Modern Grid Initiatives

Baltimore Gas & Electric



**BG&E Rolls Out 2 Million Meter Initiative;
Seeks \$200 Million from Feds (July 15, 2009)**

Smart Grid Demonstrations

- Smart Grid Regional Demonstrations
- Synchrophasor Demonstrations
- Utility-Scale Energy Storage Demonstrations



Paths to a Smart Grid



Energy Independence and Security Act (EISA) 2007

- TITLE I—ENERGY SECURITY THROUGH IMPROVED VEHICLE FUEL ECONOMY
- TITLE II—ENERGY SECURITY THROUGH INCREASED PRODUCTION OF BIOFUELS
- TITLE III—ENERGY SAVINGS THROUGH IMPROVED STANDARDS FOR APPLIANCE AND LIGHTING
- TITLE IV—ENERGY SAVINGS IN BUILDINGS AND INDUSTRY
- TITLE V—ENERGY SAVINGS IN GOVERNMENT AND PUBLIC INSTITUTIONS
- TITLE VI—ACCELERATED RESEARCH AND DEVELOPMENT
- TITLE VII—CARBON CAPTURE AND SEQUESTRATION
- TITLE VIII—IMPROVED MANAGEMENT OF ENERGY POLICY
- TITLE IX—INTERNATIONAL ENERGY PROGRAMS
- TITLE X—GREEN JOBS
- TITLE XI—ENERGY TRANSPORTATION AND INFRASTRUCTURE
- TITLE XII—SMALL BUSINESS ENERGY PROGRAMS
- TITLE XIII—SMART GRID
- TITLE XIV—POOL AND SPA SAFETY
- TITLE XV—REVENUE PROVISIONS
- TITLE XVI—EFFECTIVE DATE



NIST Leading the Way

As part of the Energy Independence and Security Act (EISA) of 2007, the National Institute of Standards and Technology (NIST) has “primary responsibility to coordinate development of a framework that includes protocols and model standards for information management to achieve interoperability of smart grid devices and systems...”

[EISA Title XIII, Section 1305]



Near-Term Actions for NIST to advance the Interoperability Framework

- Developing a common semantic model
- Developing a common pricing model
- Developing a common semantic model for advanced metering, demand response, and electric transportation
- Conducting an analysis to select Internet Protocol Suite profiles for smart grid applications
- Investigating Communications Interference in Unlicensed Radio Spectrums
- Developing common time synchronization and management
- Coordinating efforts across Standards Development Organizations

Source: “Report to NIST on the Smart Grid Interoperability Roadmap,” prepared by EPRI, released June 17th, 2009.



DOE smart grid announcements

- **Smart Grid Investment Grant Program**

- Refers to Section 1306 of Energy Independence and Security Act of 2007 (EISA), later modified by the American Recovery and Reinvestment Act of 2009 (ARRA)
- “... federal assistance to cover up to fifty percent of investments by electric utilities and other entities for projects that promote the goal of deployment, including development of component technologies.”
- Minimum 50% cost share

- **Smart Grid Demonstrations**

- Three areas covered: Smart Grid, Synchrophasors, and Energy Storage
- Minimum 50% cost share

Smart Grid Investment Grant program

- Eligible applicants
 - Investor-owned and municipality-owned utilities
 - Rural electric cooperatives
 - Load serving/distribution companies
 - Retail distributors or marketers of electricity
 - System operators
 - “Manufacturers of appliances and equipment to enable smart grid functionalities”

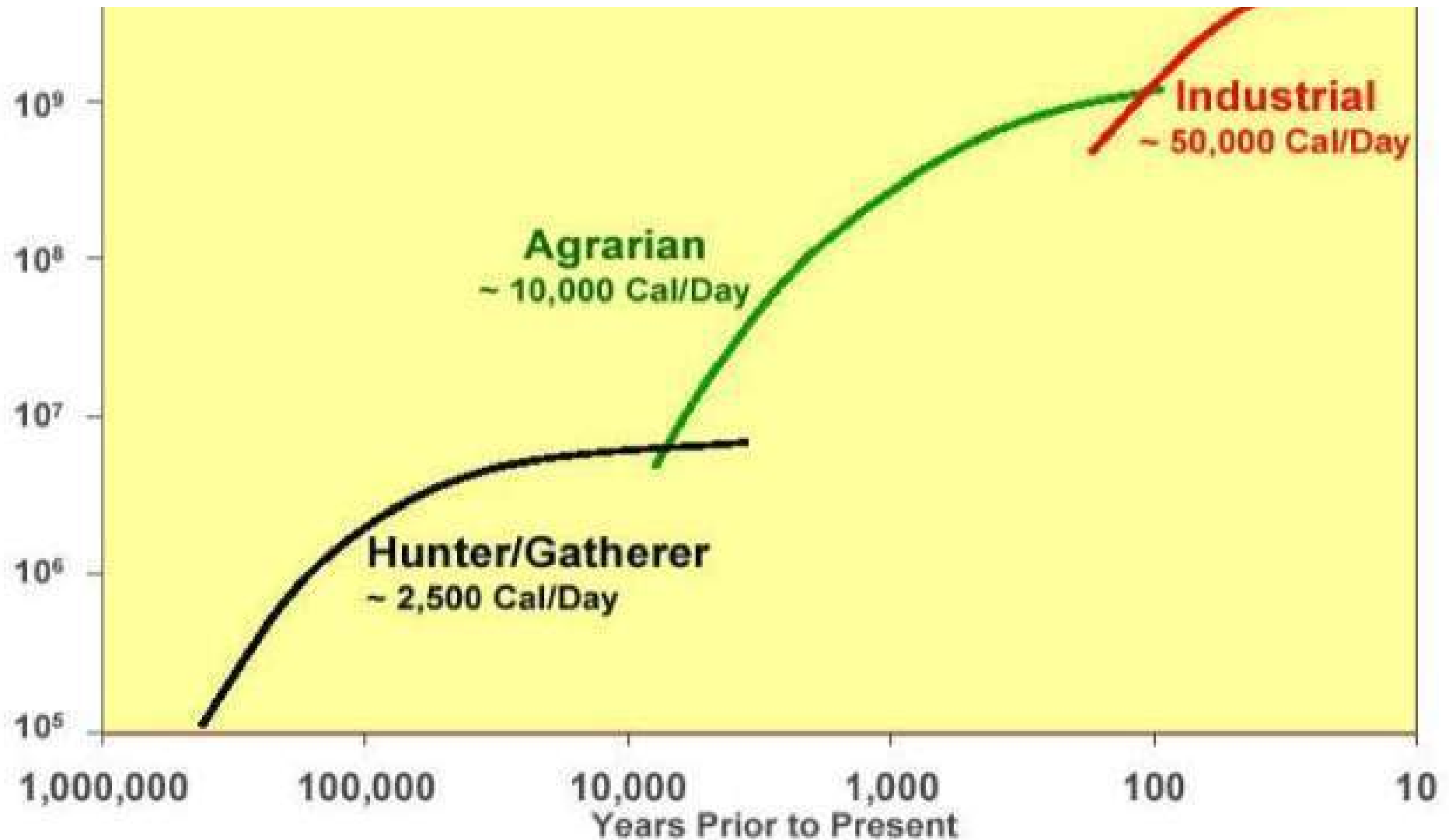


Smart Grid Investment Grant program

- Projects should support or advance one or more smart grid functions for example:
 - Develop, store, send, and receive digital information concerning
 - Electricity use, costs, prices, time of use, nature of use
 - Storage or other relevant information
 - Measure or monitor electricity use as a function of
 - Time of day, power quality characteristics
 - Source or type of generation
 - Store, synthesize or report that information
 - Address system security, especially cyber security, concerns
 - Automatic (or manually preprogrammed) response of appliances and machines



Context: Cycles of demographic Growth



Observations

- Critical importance of **consumer empowerment** and end-to-end system modernization
- If the transformation to smart grid is to produce real strategic value for our nation and all its citizens, our goals must include:
 - To **seamlessly integrate and optimize electricity supply and demand**, and
 - To enable **every building and every node to become an efficient and smart energy node**.
- Considerable effort is focused on interstate transmission, on incremental improvements and maintaining the regulated monopoly service status-quo to avoid stepping on states' rights.
 - This will inevitably undermine most of the real smart grid value by continuing the business as usual of the past, rather than for enhancing the reliability, efficiency, security and quality of consumer services.



...The Future is Bright...



Courtesy FPL Energy

Policy, Science and Technology Must Support This Transformation: Recommendations

- Establish the “Smart Grid” and “self-healing” interdependent infrastructure security & protection as national priorities
- Authorize increased funding for R&D and demonstrations of the “Smart Grid”, and interdependency R&D, resilience/security
- Revitalize the national public/private electricity infrastructure partnership needed to fund the “Smart Grid” deployment

M. Amin’s briefing at the U.S. Congressional R&D Caucus (www.researchcaucus.org) on March 26, 2009

© 2009 No part of this presentation may be reproduced in any form without prior authorization.



Enabling a Stronger and Smarter Grid:

- Broad range of R&D including end-use and system efficiency, electrification of transportation, stronger and smarter grid with massive storage
- Sensing, Communications, Controls, Security, Energy Efficiency and Demand Response *if architected correctly* could assist the development of a smart grid
- Smart Grid Challenge/Opportunity areas include:
 - Distributed Control
 - Grid Architectures
 - Cyber Security

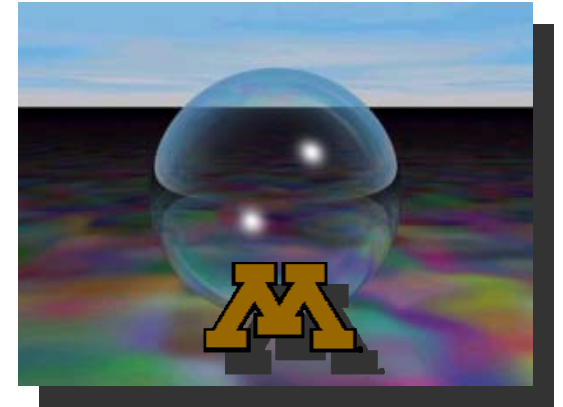


M. Amin's briefing at the U.S. Congressional R&D Caucus (www.researchcaucus.org) on March 26, 2009

The CoLAB Model

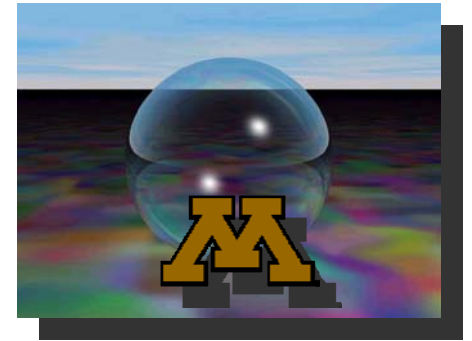
Each collaboratory is a nimble, for-profit skunkworks, that enables the University's 'best and brightest' students and faculty to collaborate with multiple corporate partners to rapidly co-create innovative IP, products, or service. Each new venture:

- Is a 'persistent innovation platform' that shares rights and royalties from co-invented IP among its collaborators and investors
- Has a defined project mission, clear ROI focus and time-to-market urgency
- Targets a high-growth niche which leverage collaborator core competencies



Gary Smaby, Director
Collaborative Innovation
OVPR, U of M

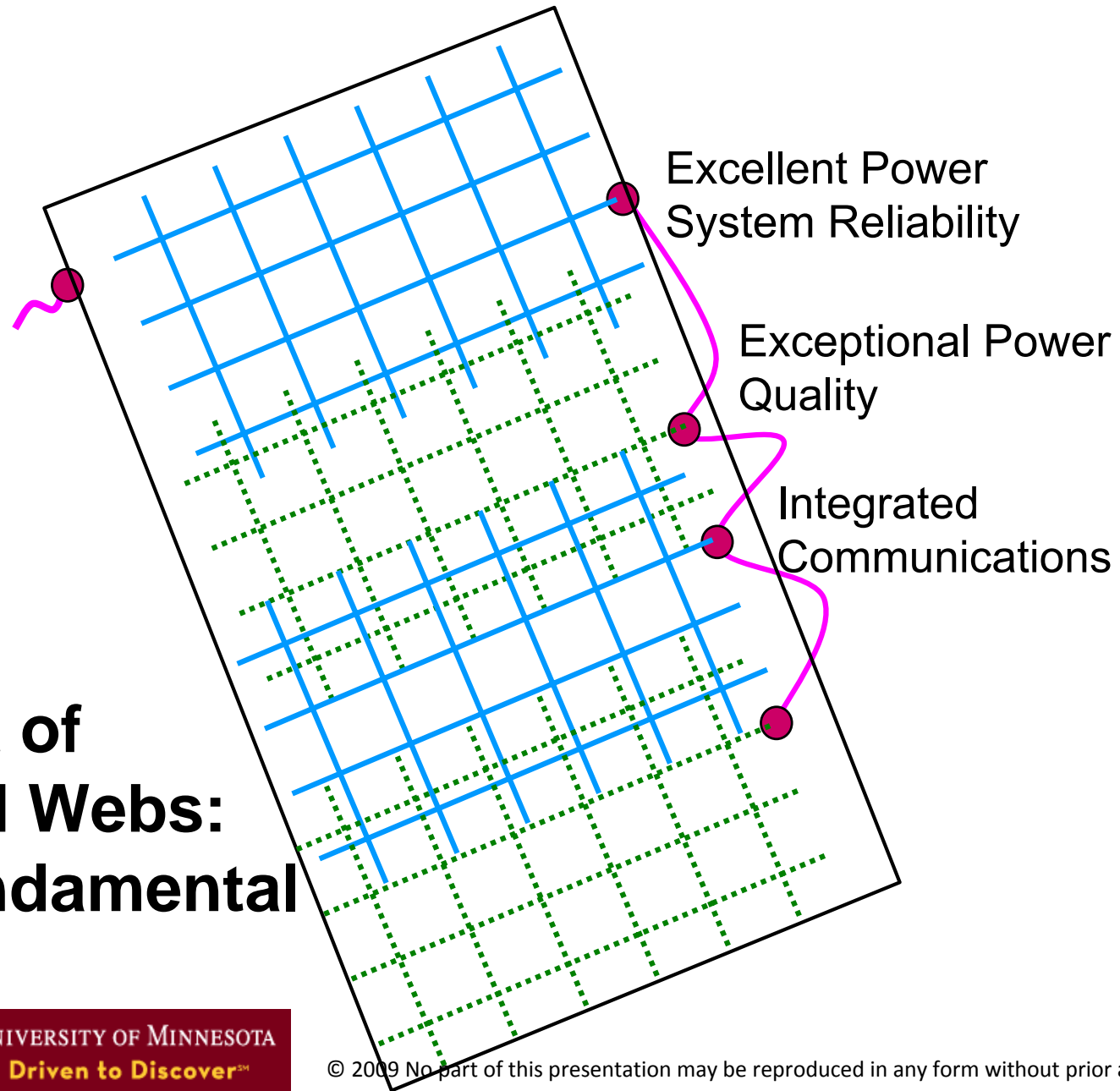
What's the University's Role?



- The University of Minnesota designed its Collaboratory model as an **innovation framework** to facilitate the rapid creation and **commercialization of new IP in multi-party collaborations**.
- The University funded a three-year, \$500,000 pilot initiative called **Innovation by Design** which successfully tested the concepts underlying the model
- The University maintains an **indirect vested interest** in each collaboratory through a 'surrogate' venture fund professionally managed by the University of Minnesota Foundation Investment Advisors (UMFIA).

The Smart Infrastructure for a Digital Society

A Secure Energy Infrastructure



A Complex Set of Interconnected Webs: Security is Fundamental

An Example: Smarter I-35W bridge

Just after 6:00 p.m. on Aug. 1, Prof. Massoud Amin was at work in his office on the University of Minnesota's West Bank, where he heard and watched the unthinkable happen—the collapse of the I-35W bridge about 100 yards away.

“As an individual, it was shocking and very painful to witness it from our offices here in Minneapolis,” says Amin, director of the Center for the Development of Technological Leadership (CDTL) and the H.W. Sweatt Chair in Technological Leadership. Amin also viewed the tragedy from a broader perspective as a result of his ongoing work to advance the security and health of the nation's infrastructure.

In the days and weeks that followed, he responded to media inquiries from the BBC, Reuters, and the CBC, keeping his comments focused on the critical nature of the infrastructure. He referred reporters with questions about bridge design, conditions, and inspections to several professional colleagues, including Professors Roberto Ballarini, Ted Galambos, Vaughan Voller, and John Gulliver in the Department of Civil Engineering and the National Academy of Engineering Board on Infrastructure and Constructed Environment.

For Amin, Voller, and many others, the bridge collapse puts into focus the importance of two key issues—the tremendous value of infrastructure and infrastructure systems that help make possible indispensable activities such as transportation, waste disposal, water, telecommunications, and electricity and power, among many others, and the search for positive and innovative ways to strengthen the infrastructure.



I-35W bridge

- In less than a year, a city of sorts with an ever-changing landscape has taken shape, complete with a host of heavy-duty equipment, temporary on-site areas for casting and other tasks, and crews constantly at work.
- The days and months that followed required extraordinary efforts from many, including our alumni of the Master of Science in Infrastructure Systems Engineering (ISE) program.

→ **Sensors built into the bridge (at less than 0.5% of total cost).**



Terry Ward



Heidi Hamilton



Val Svensson



Joe Nietfeld

Contributors

The construction of the new I-35W bridge involves many professionals, including the following list of CDTL alumni who have lent their expertise to the project:

B. J. Bonin, ISE '05

Charles Cadenhead, ISE '04

Jon Carlson, MOT '99

Brian Connolly, ISE '06

Petra DeWall, ISE '02

Pete Jenkins, ISE '08

Heidi Hamilton, ISE '04

Brian Kamnikar, ISE '03

Joe Nietfeld, ISE '07

Chris Roy, ISE '02

Michael Schadegg, ISE '03

Val Svensson, ISE '06

Terry Ward, ISE '05

Technological Leadership Institute (TLI) at the University of Minnesota

- Established in 1987 with an endowment from Honeywell Foundation.
- Expertise in the interface of **business, strategy, innovation, technology, leadership, and policy.**
- An interdisciplinary center housed in the Institute of Technology (engineering, mathematics, and physical sciences college).



What Does TLI Do?

➤ Master of Science degrees

- Management of Technology (1990)
- Infrastructure Systems Engineering (2000)
- Security Technologies (2010), with options for the MS, and MS/PhD minors

➤ Short Courses, Seminars, and Certificates

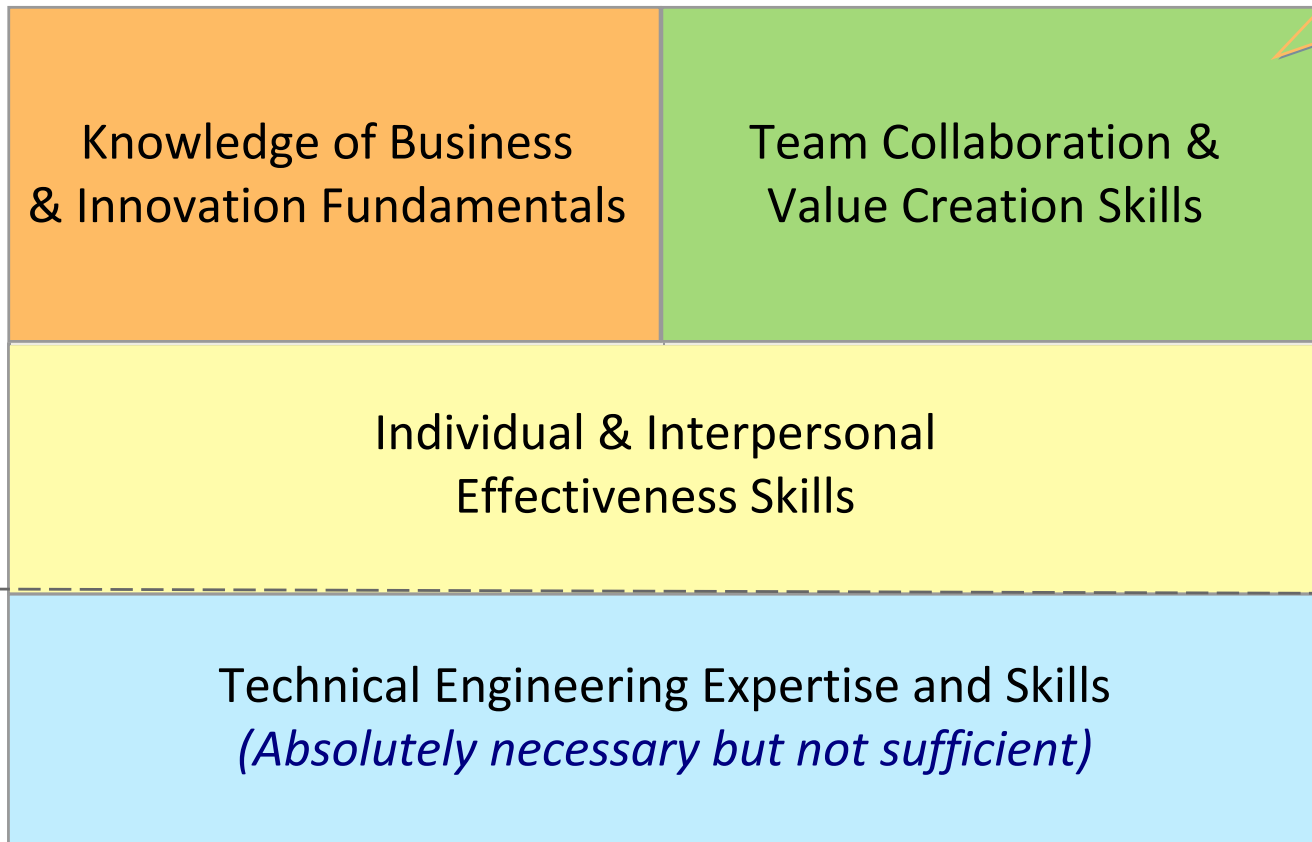
- Certificate Programs and *Summit Certification*
- Fall *Signature Series* “Best of Technology Management”
- Customized Leadership Training and Courses
- *Foresight After Four*

➤ Research and Consulting

➤ Web site: <www.TLI.umn.edu>

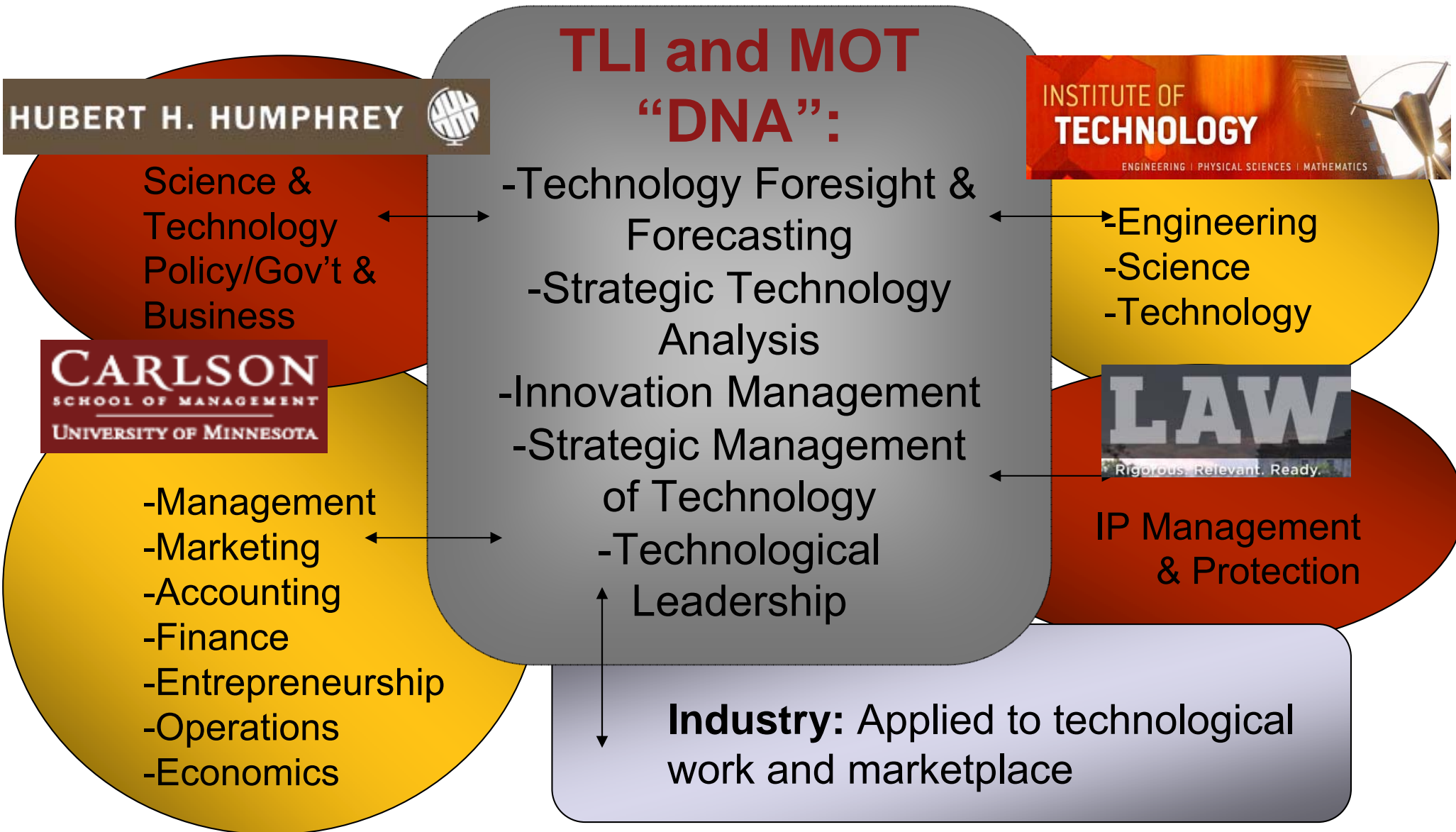


Critical Knowledge and Skills for Professionals in Tech-Intensive Environments



Technical Expertise

Leadership and Management at the Interface: Tactics and Strategies to Help You Lead the Way



MOT Curriculum >> *Topics Breakdown**

MOT Business Foundation Courses	MOT Strategic Technology Management Emphasis Courses		MOT Leadership Emphasis Courses
<ul style="list-style-type: none"> • Management Accounting • Financial Management for Technology-Based Organizations • Managing Information Resources in Technology-Based Organizations • Marketing Management for Technology-Based Organizations • Operations Management for Competitive Advantage 	<ul style="list-style-type: none"> • Developing New Technology Products • International MOT Project (Int'l Management) • Macroenvironment of Technology • Managing Intellectual Property • Managing Organizations in a Technological Environment 	<ul style="list-style-type: none"> • Managing Technological Innovation • Pivotal Technologies • Project & Knowledge Management • Strategic Management of Technology (Strategic Mgmt) • Strategic Technology Analysis • Technology Foresight & Forecasting 	<ul style="list-style-type: none"> • Business Communication • Conflict Management • Corporate Responsibility (Ethics) • Science & Technology Policy • MOT Capstone Project • MOT Leadership Effectiveness

Credits: 24% Business Fdtn + 62% Strategic Technology Mgmt + 14% Leadership

Interwoven with Leadership and Organizational Effectiveness Series:

*Leading Innovative Organizations
Collaboration & Team Leadership
Leadership Versatility*

**Courses highlighted in maroon show MOT and EMBA content overlap. Courses highlighted in blue are not offered in EMBA or MBA programs.*

Management of Technology (MOT) program

International MOT Project (MOT 8950)



Master of Science in Management of Technology (MS-MOT)

International MOT Project (MOT 8950)

- Each year, the MOT international project committee in TLI explores possible locations. The committee considers options to meet the planned goals of “developing an international perspective on management of technology and contrasting emerging and established companies, countries, technology, foreign-owned versus local, and government versus private sector, among other factors, in concert with the Center’s mission,” says Dr. Massoud Amin, TLI director.
- “It also provides an ability to develop a coherent intellectual structure within this region/country and an understanding of complex issues in the global management of technology. We are constantly in the learning mode, trying to find new locations, new sites to visit, and new contacts.”
- The international MOT project plays an important role in preparing students to assume greater leadership responsibilities in the global market and it lays a foundation for students to tap throughout their careers.
- “It gives them an important perspective on the management of technology,” says Dr. Amin. “It helps them in a systematic and integrated manner to see and investigate the impact of a strategic global vision.”

>>INT'L MOT PROJECT

- 2nd year; last/spring semester
- 12-14 days
- Sites selected by TLI
- Int'l MOT academic and industry exposure
- Contrasts: Economies, technological capabilities, types of high-tech industries
- MOT perspective of: Economic, social, political, governmental, business environments
- Pre- and post-trip assignments

International MOT Project 2007:

Successfully delivered during April 14 through 28, 2007

Academic Goals:

- Contrast between emerging & established (companies, countries, technology, foreign-owned vs. local, govt. vs. private sector, etc.)
- Management of Technology content;
- A “non-U.S. International” academic perspective on MOT;
- Ability to develop a coherent intellectual structure within this region/country (content, sequence, flow)



Successfully held in [Delhi](#) and [Bangalore](#)

- May 5th class: Final project presentations/findings in India by the MOT07 class, we focused on areas of IT, Pharma/Biosci, Aerospace/Defense, Agribusiness and Technologies (we all got sick in this trip... but great evaluations and experiences).
- Mr. Tony Lorusso's (Executive Director of the Minnesota Trade Office) participated on behalf of Governor's office; all was very well received.



The 13th International MOT Project: March 23-April 6, 2008

Academic Goals:

- Contrast between emerging & established (companies, countries, technology, foreign-owned vs. local, govt. vs. private sector, etc.);
- Management of Technology content;
- A “non-U.S. International” academic perspective on MOT;
- Ability to develop a coherent intellectual structure within this region/country (content, sequence, flow)

Successfully held in Delhi and Bangalore:

- Final project presentations/findings in India focused on:
 1. Energy,
 2. Information Technologies (IT),
 3. Medicine/Pharma/Biosciences,
 4. Infrastructure Development,
 5. R&D centers and Innovation.

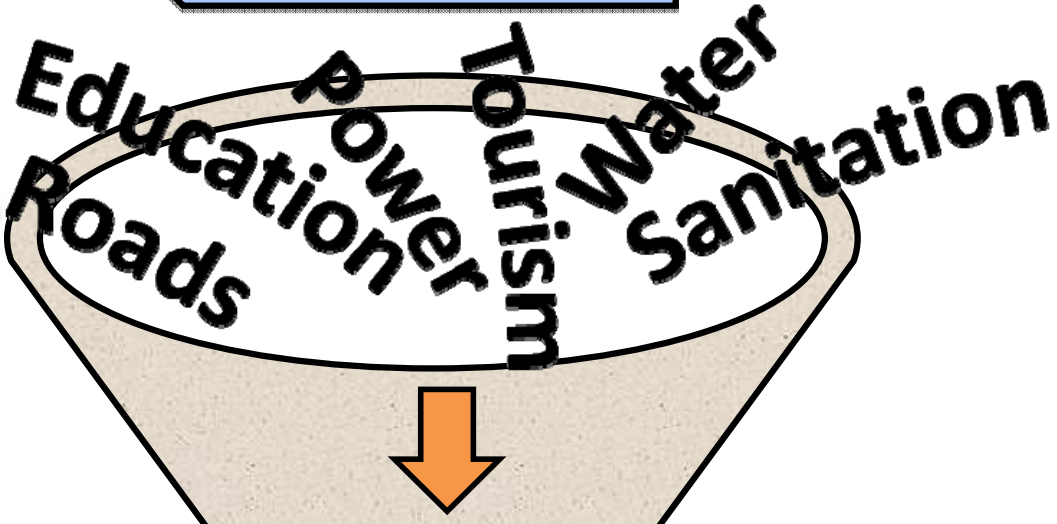


We gratefully acknowledge:

- All of IIT-Delhi and Professors Sushil, Momaya, Yadav and colleagues
- All of IISc and Professors Bala Subrahmanya, Simha, and colleagues
- Professor Rishi at IIM Bangalore
- Outstanding presenters from Government, NGOs, and companies including Honeywell, 3M Innovation Center, SAP Labs, Hero Honda



Opportunities



Technologies



OSMONICS



Northwoods Professional Group



CARLSONSM



UNIVERSITY OF MINNESOTA



Honeywell



DonaldsonSM
Filtration Solutions

HDR

3M



ONE COMPANY
Many Solutions[®]



Technological
Leadership Institute



UNIVERSITY OF MINNESOTA
Driven to DiscoverSM

Technological Leadership Institute (TLI)

Management of Technology (MOT) program

MOT 8950 (Int'l MOT Project course)

2010	Singapore and Vietnam
2009	Singapore and Kuala Lumpur
2008	New Delhi and Bangalore
2007	New Delhi and Bangalore
2006	Shanghai and Beijing
2005	Dublin and Munich
2004	Dublin, Berlin, Dresden and Wolfsburg
2003	Dublin, Wolfsburg and Hamburg
2002	Reykjavic and Dublin
2001	Kuala Lumpur and Singapore
2000	Shanghai and Singapore
1999	Shanghai and Singapore
1998	Shanghai and Singapore
1997	Shanghai and Singapore
1996	Singapore and Beijing

MOT 2009: Teams and Foci

Singapore Economic Development Board & Minnesota: Opportunities

Jakob Ledgerwood, Debbie Lee, Matthew Mensah, and Matt Aro

Research & Development Policy

Stephanie Seward, Chris Schmoeckel, Ramaswamy Sastri, and Kulwant Kaur

Entrepreneurship in Singapore

Anders Syverson, Pat Nseumen, Lyra Hernandez,

Nate Rowe, and Xinping Zhang

Advanced Electronics: R&D vs. Manufacturing Electronic Technologies

Tess Surprenant, Travis Lott, Thad Olson, Mike Begich, and Mike Siegler

Workforce in S&T Context

Tina Billstrom, Andy Harkison, Mark Hove, Rajesh Raghunath,

Quinn Sanford, and Jon Wood

Education System Analysis

**Amy Raatikka, Erik Peterson, Joshua Sillers, Kuwam Alowonle, Luke Pfothenauer,
and Shanti Godishala**

MOT 2009 IMTP Site Visits

21 Mar – 6 Apr 2009
Singapore / Malaysia

- **Singapore:**

U.S Interests

American Chamber of Commerce
U.S. Embassy
National University of Singapore

National Strategy for Business

Economic Development Board
Spring Singapore

National Strategy for Technology

A*STAR
SIMTech
Genomic Institute of Singapore

Corporate Visits

Siemens
Infineon
Globecast
Atos Origin
Boeing
Autoscan

- **Malaysia:**

Corporate Visits

Royal Selangor
IBM
Celframe

- **Sidebar Visits:**

Rosemount
GE Security
3M
Fusionopolis Contact
Frost & Sullivan
Cargill
Johnson Controls
Cummins

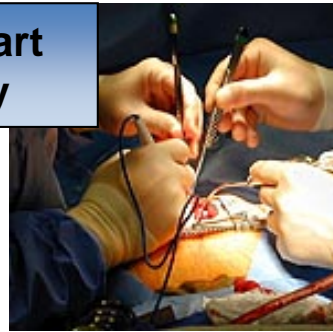
Entrepreneurship

- Institute of Technology Founders 2005 Survey of alumni who have started businesses:
 - 15,000 alumni responded
 - 3,024 have founded one or more companies
 - 4,150 active companies, worldwide, employing 551,000, with annual revenue of \$90B
 - 2,600 active companies in Minnesota, employing 175,000, with annual revenue of \$46B
- Faculty also active in start-ups, often with former graduate students.

Taconite



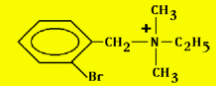
Open Heart Surgery



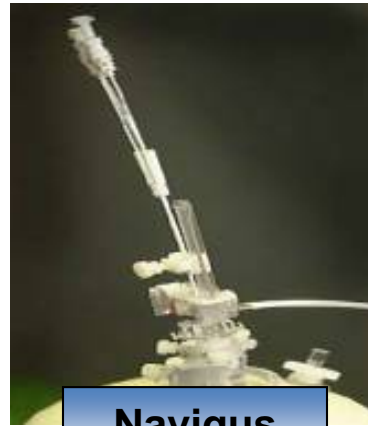
Pacemaker



Brethilium



Ziagen

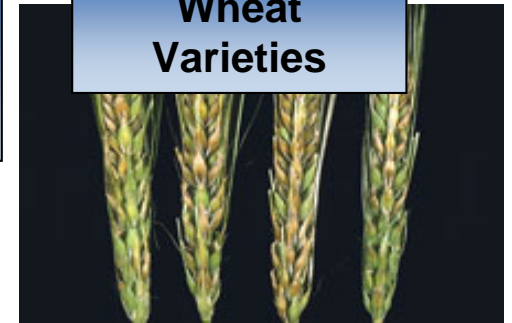


Navigus

Vest Airway Cleaning System



Wheat Varieties



MRI Coil

Grape/Wine Varieties



PRRS Vaccine

Flight Data Recorder



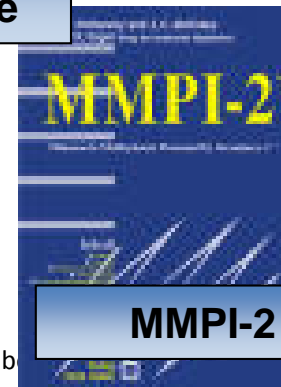
Gentle Leader Head collar



Radius Plate



Heads-up Display



MMPI-2

Seatbelt



An Engine for Economic Growth

GDP Density



Satellite picture of the earth at night



Globally Interlocked Dynamics: Understanding the Full Impacts of Decision Pathways



To unfold the full potential of social progress requires an integrated understanding of the many dimensions of social development, their underpinnings, and the role of science and technology.

Technology as a Hinge

- In the past, we have been unable to account for all areas on the interlocking fan
- Decisions have been made with incomplete information
- New technologies now permit us to identify forcing functions, critical junctures, and pinch points
- Goal: To target our constrained development resources to maximize benefit and minimize unintended consequences



Contrasting Stories of Development

- 1) Southern Coast of Taiwan:
An example.
- 2) Advanced Industrial Societies.
- 3) Mali: Another example
 - “Industrial Cuisinart”
 - Grind grain, husk rice, saw wood, pump water, charge batteries
 - Female literacy up -- due to more free time & the need to account for operation, earnings, salaries
 - Meal quality improved
 - Social shifts between men & women

Results of Uneven Distribution of Technology Benefits

In developing nations:

- Population dislocations
- Social upheaval
- Massive debt

In developed nations:

- Crumbling infrastructure
- Environmental pollution
- Unhealthy lifestyles

Resource Allocations: From Primitive Countries Survival, to Underdeveloped Countries, to Developing Countries, to Developed Industrial Economies



Observation: We don't know the tipping point at which conflict over uneven distribution of resources will impact developed nations on a large scale.

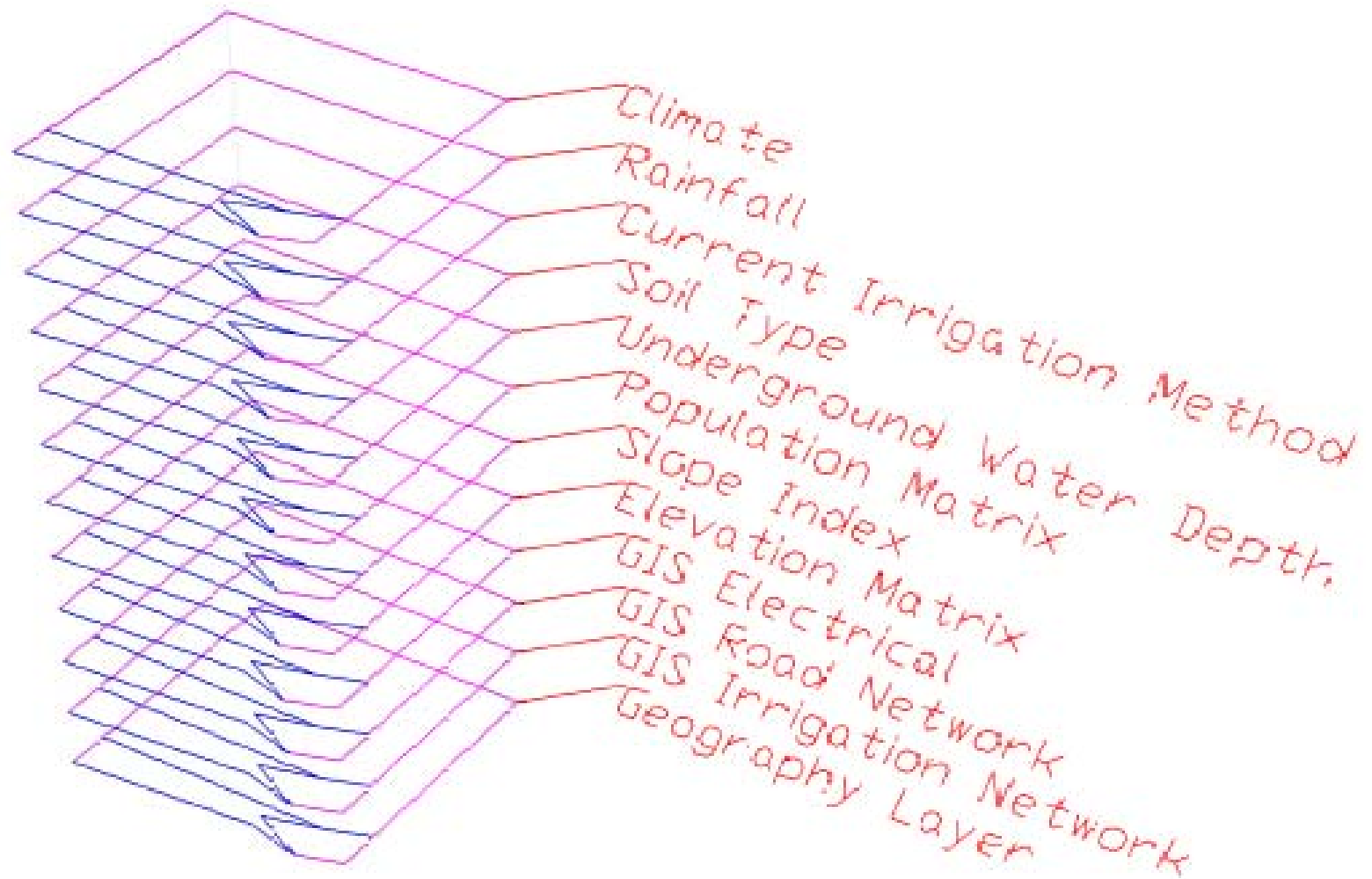
Global Transition Dynamics

- The **aim** is to produce an aggregation of the real time interaction of worldwide activities in technology, health, society, ecology, and economics.
- The **concept** is an outgrowth of past efforts of Drs. Starr and Amin to include large system risk analysis into national decision-making.
- The **product** would be an area-specific-probabilistic-vision of alternative key development decisions in each country, including pinch points, and forcing functions and their future consequences.

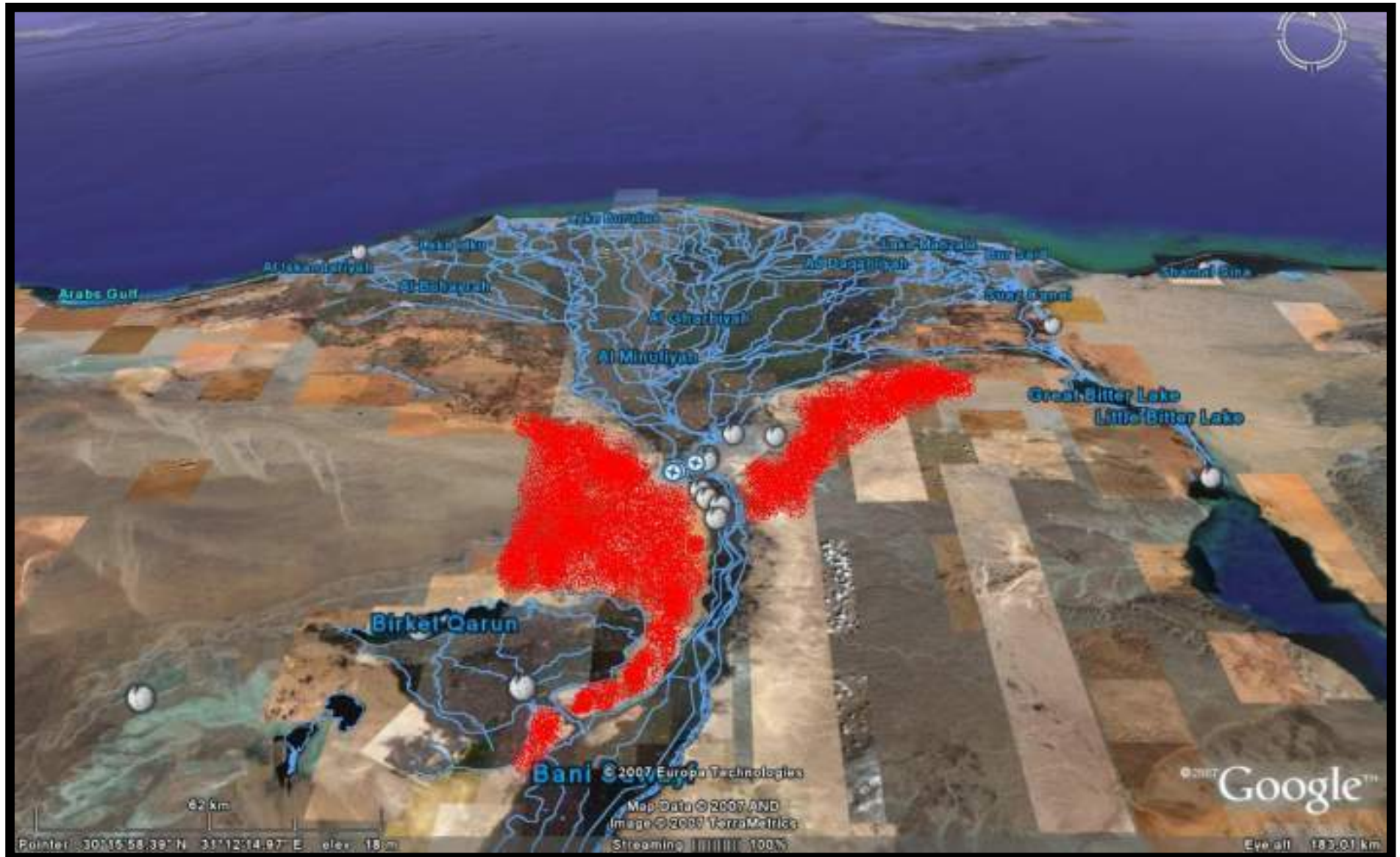


Example: EGYPT

Analysis-- Factors Affecting Agriculture



Decision Real Life Picture

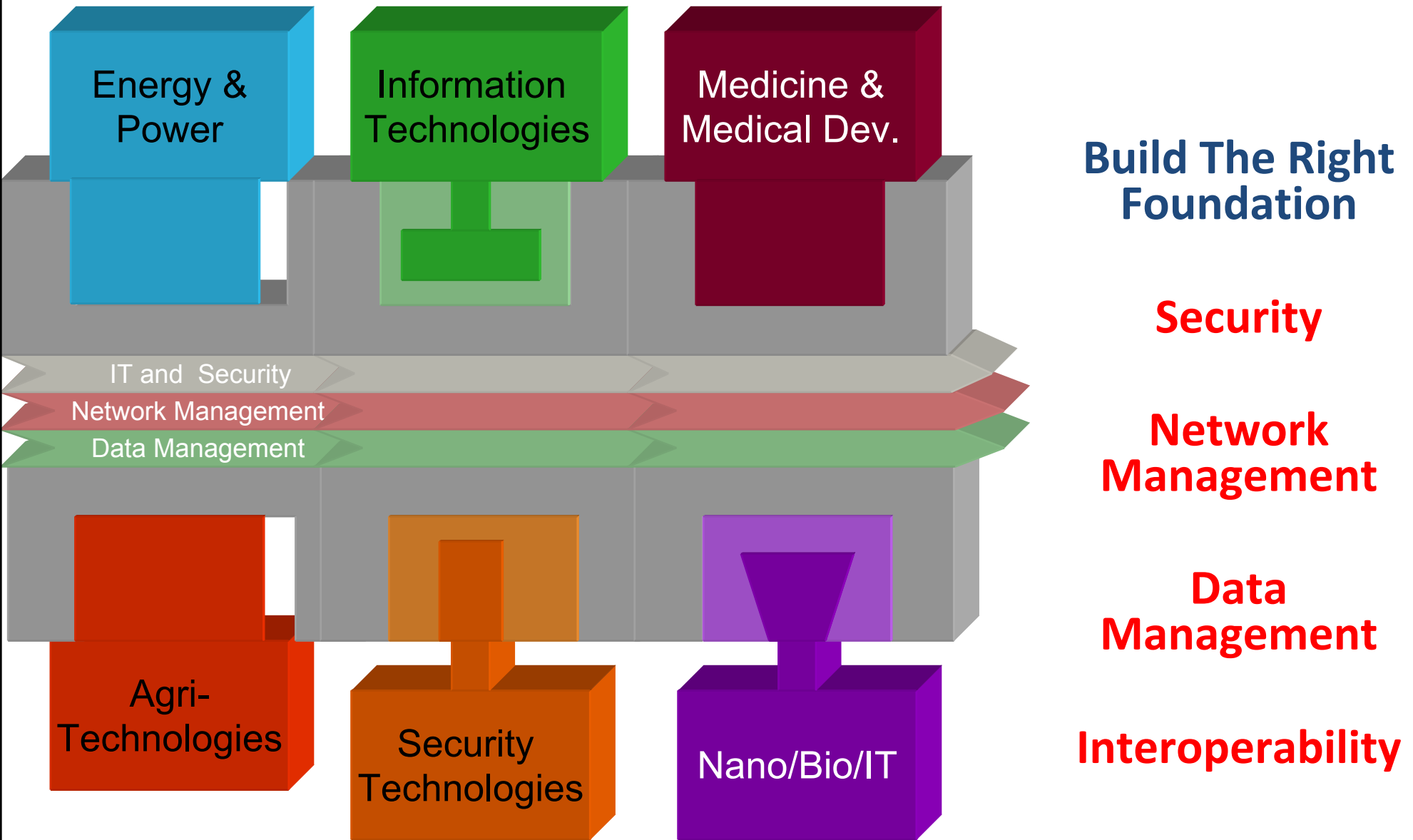


Macroeconomic Rationale

1. Endogenous growth models - theoretical support for domestic technology creation
2. $Y = f(R, K, H)$, where:
 - $Y = \text{GDP}$
 - $R = \text{R\&D}$
 - $K = \text{physical capital}$
 - $H = \text{human capital}$
3. GDP growth: a) Velocity and proportion of R, K, H, and
b) available and affordable energy: determinants of success

Minnesota's Technological Leadership Role:

Enabling Economic Growth → First Build the Right Foundation



Globalization

In the new normal...

growth & sustainable advantage will belong to those who are focused on-

– *Accelerating the velocity
and relevance of information*

•Copyright Michael Wright



LEADERSHIP REPORT CARD

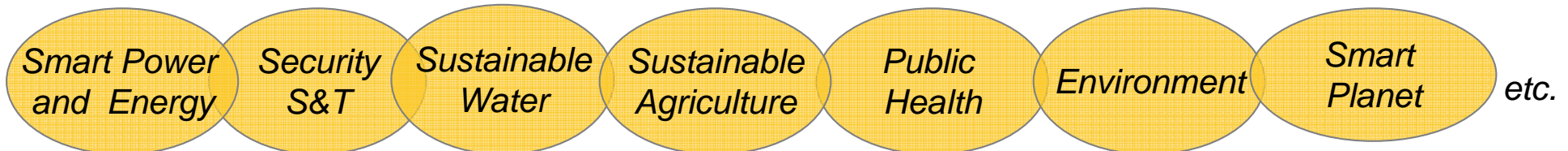
- Strategic customer relationships
- Technological health
- Market position
- Global culture
- Process disciplines
- Constant innovation
- Knowledge management systems

Focus, Alignment, Collaboration and Execution

An 'About FACE' is Required

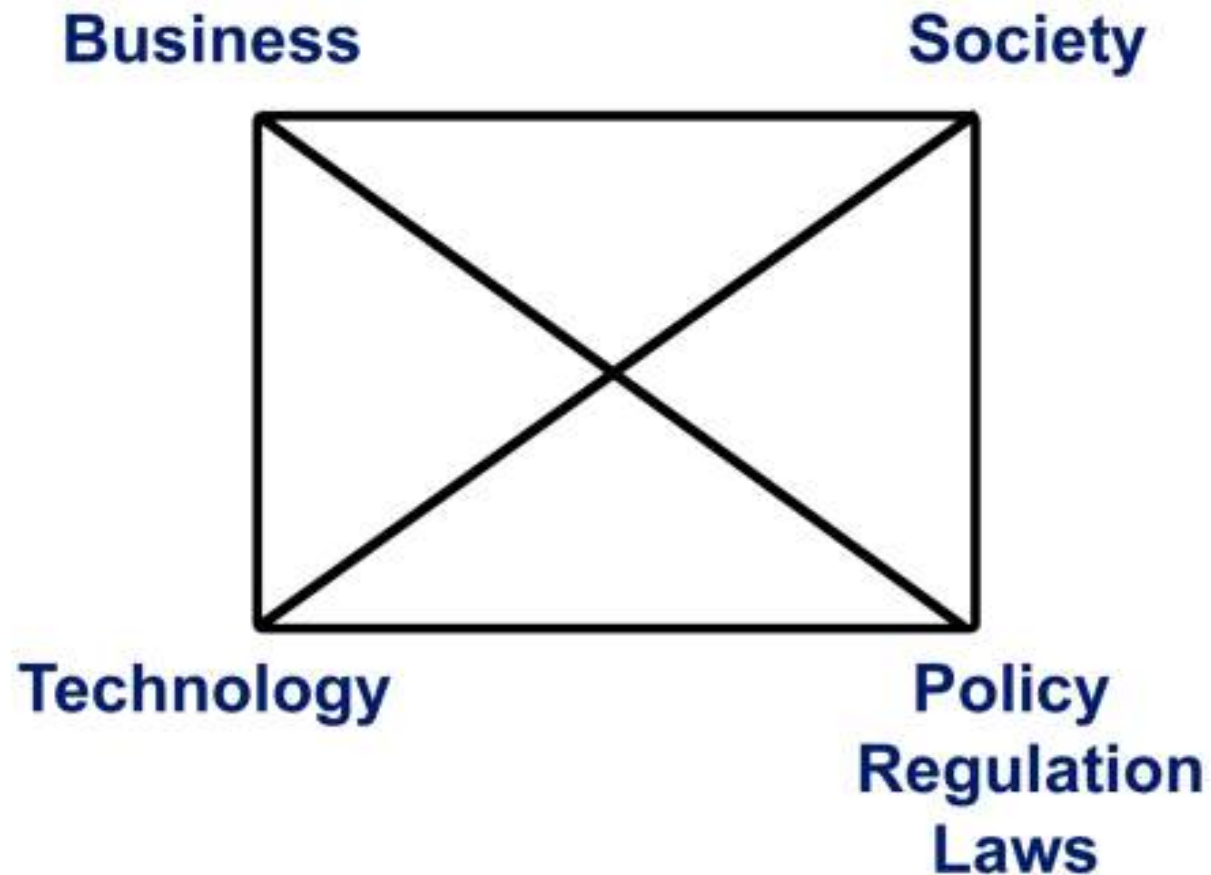
- Focus
- Alignment
- Collaboration
- Execution

*Begin with a 360 **Systems' Approach** and the End Goal in Mind:*
Focus on a few big 'problems that matter' to our nation and the world in the next half century
(versus self-interests)



Exploit Core Competencies to Address Strategic Areas:
Focus on the intersection of 3-5 problems that matter AND our core competencies (build and leverage expertise, Government/Industry/University relationships, to power economic growth).

Technology/Business/Policy Map



SWOT Analysis:

Global Opportunities for Your Organization

Strengths

Weaknesses

Internal

Opportunities

Threats

External



Short-term Moves

Recommendation	Who	What and When	How	Cost



Long-term Moves

Recommendation	Who	What and When	How	Cost



Technology is empowered by people:

Technology requires human skills, discipline and creativity to make it worth something



Discussion and the Road Ahead:

- What are the key issues facing increased opportunities and collaborations bridging China and India with MN, our nation and the world?
 - What is your vision for the future– what will it look like or how will it perform in 2010-2025?
 - What are the difficult challenges to overcome to achieve your vision?
 - What enabling technologies and policies are needed to address these?
 - What critical issues should we consider in beginning plans for 2010 and beyond?





**May others benefit from
your lead.**

Thank you